

**DGM Data Processing Notes Tracking and Equipment QC  
Checks  
Sample Separation Maps  
Parker Flats Phase II MRA, Former Fort Ord**

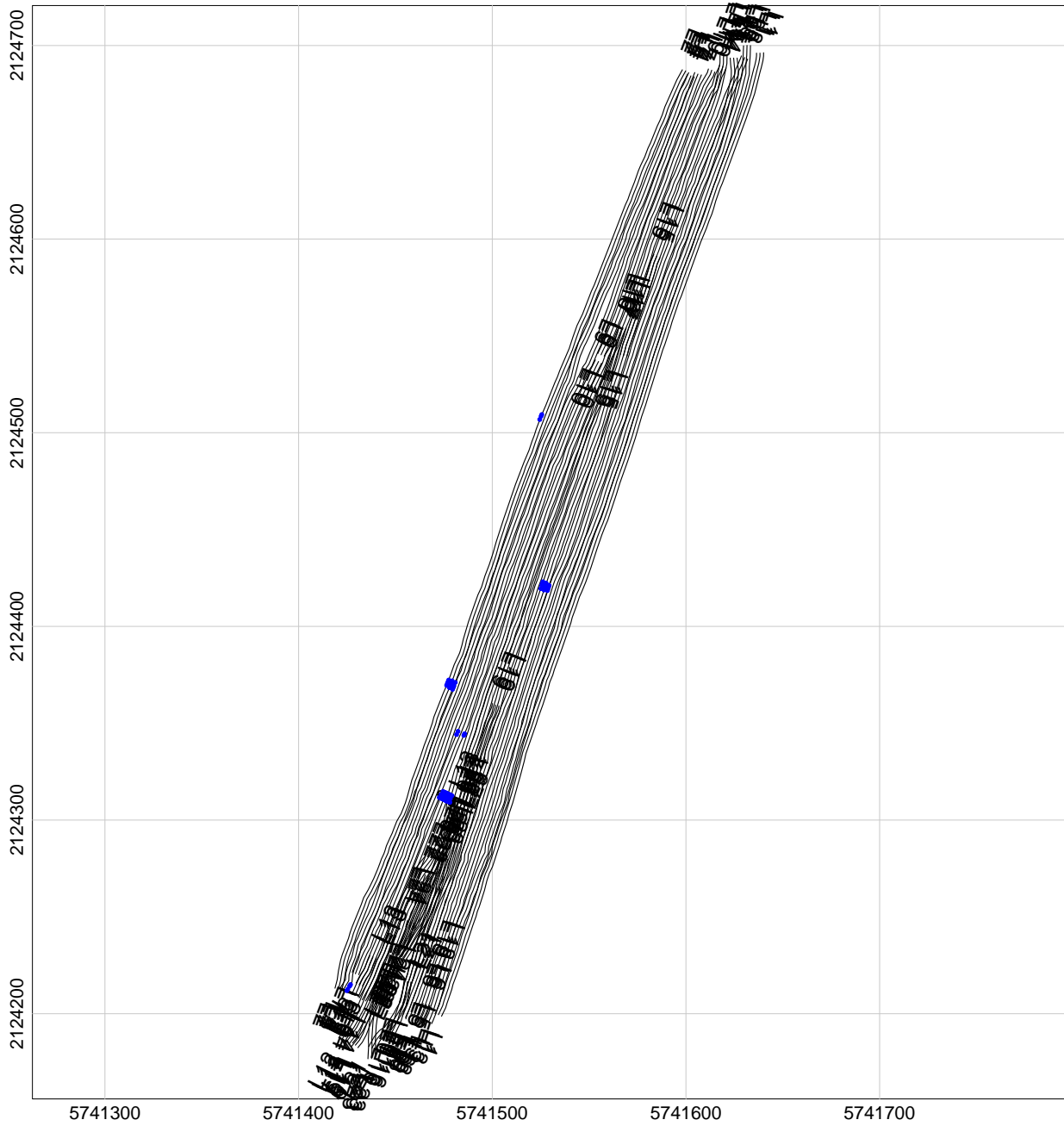

# MAP

## Sample Separation

### LEGEND

- Line path
  - Flag\_Separation
- Data exceeding max. data spacing: 0.1%

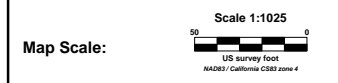

Client:	
Project: Fort Ord- Parker Flats	
Contractor:	
Created by:	Verified by:
Date:	File: 101509-1TA_DATASEP
Page number:	Approved:

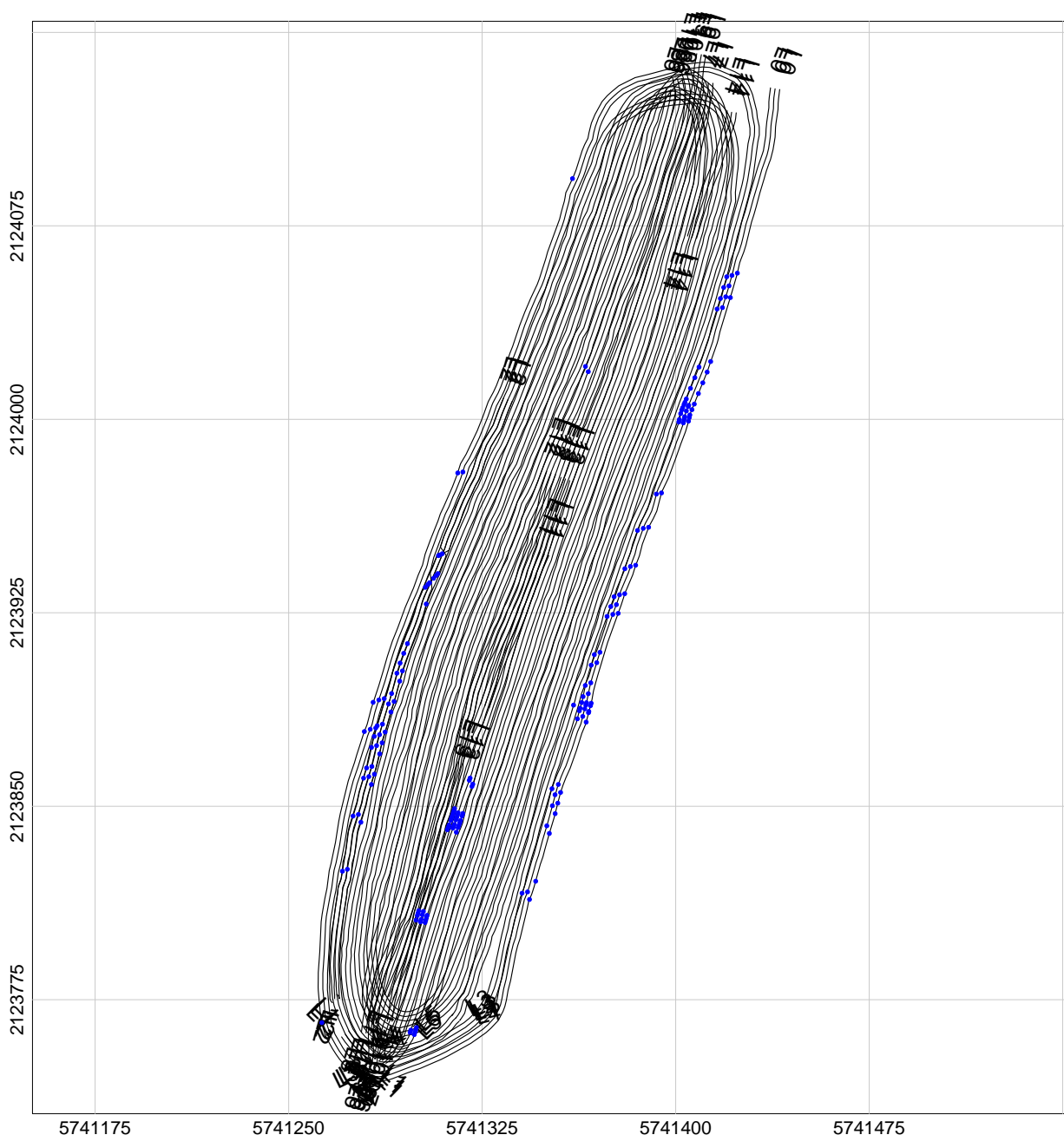

# MAP

## Sample Separation

### LEGEND

-  Line path
  -  Flag\_Separation
- Data exceeding max. data spacing: 0.3%

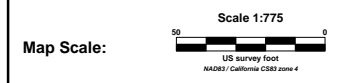



Client:	
Project: Fort Ord- Parker Flats	
Contractor:	
Created by:	Verified by:
Date:	File: 101609-1TA_DATASEP
Page number:	Approved:

# MAP

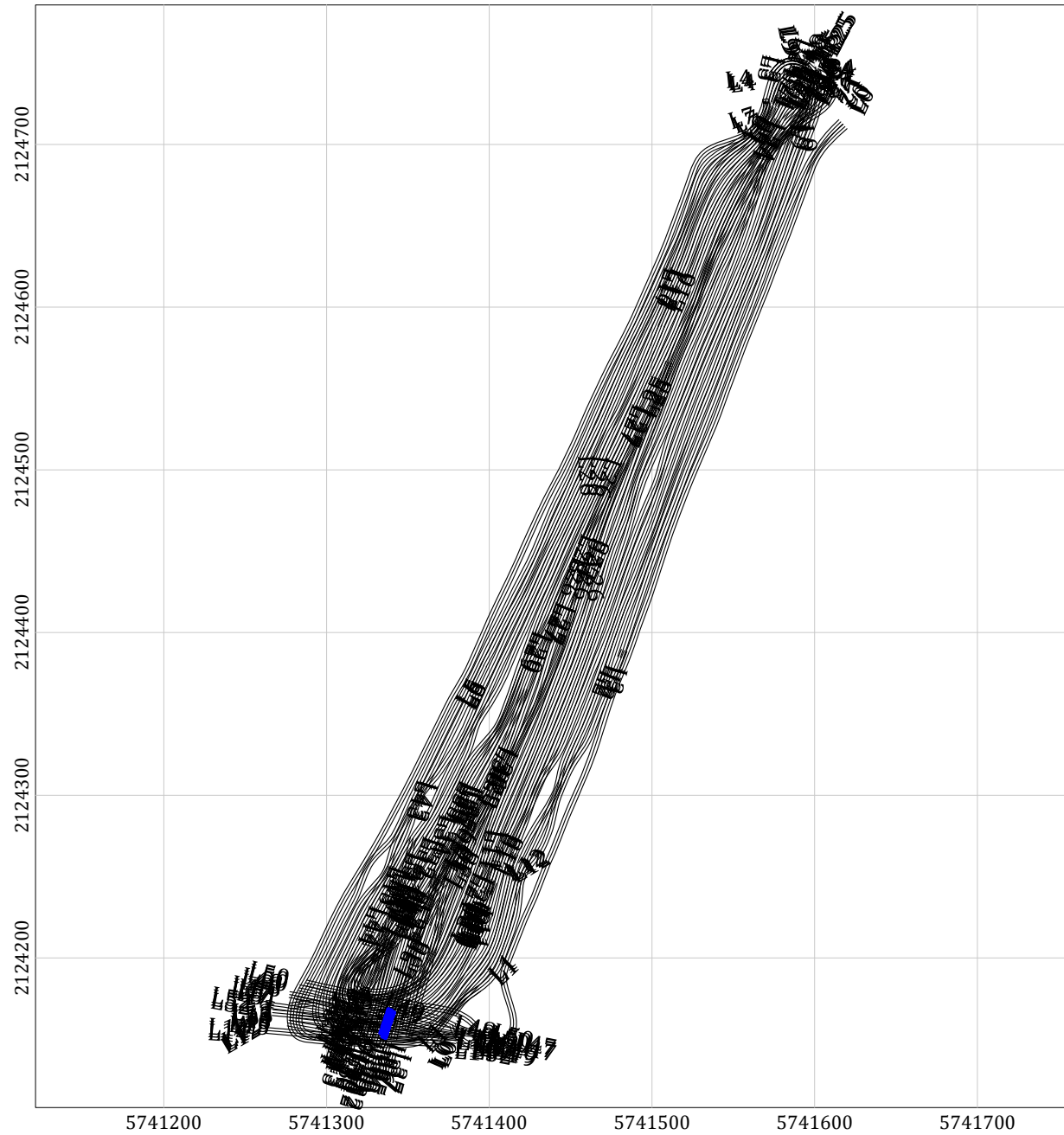
## Sample Separation



### LEGEND

-  Line path
  -  Flag Separation
- Data exceeding max. data spacing: 0.0%





Client:	
Project:	
Contractor:	
Created by:	Verified by:
Date:	File: 101909-1TA_DATASEP
Page number:	Approved:

# MAP

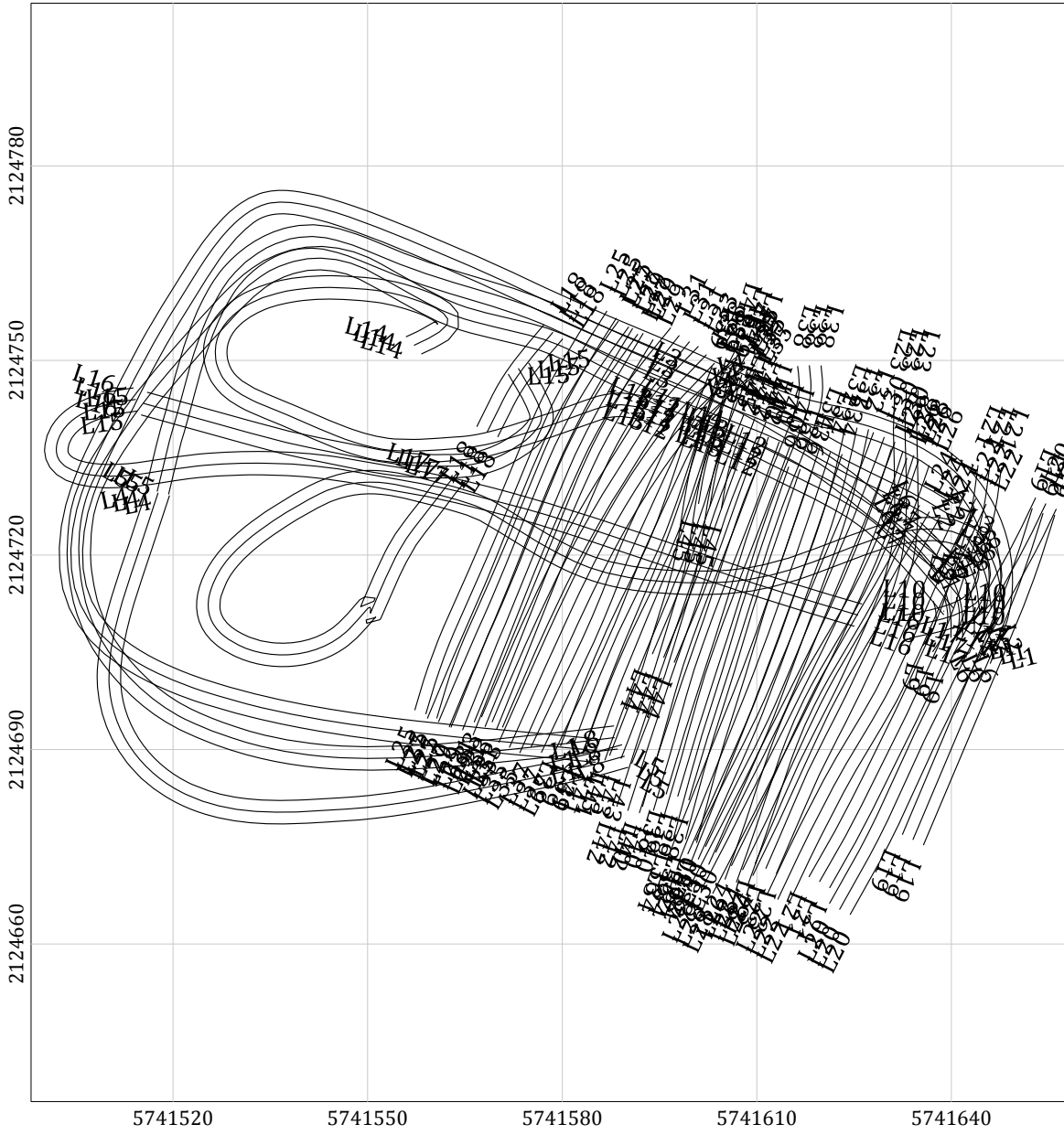
## Sample Separation



### LEGEND

-  Line path
  -  Flag\_Separation
- Data exceeding max. data spacing: 0.0%

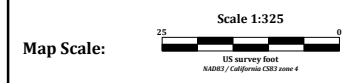

Client:	
Project:	
Contractor:	
Created by:	Verified by:
Date:	File: 101909-2TA_DATASEP
Page number:	Approved:

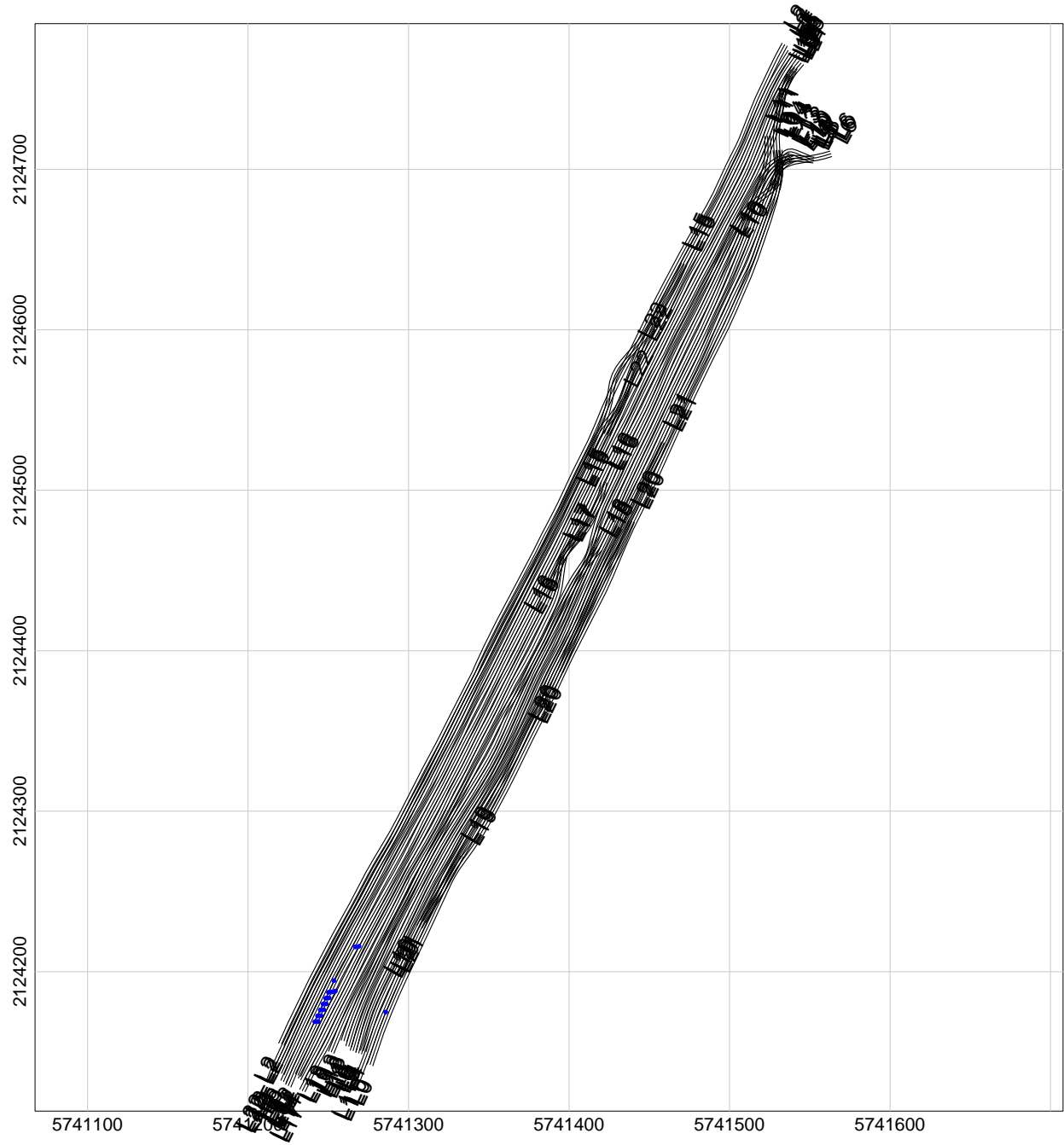

# MAP

## Sample Separation

### LEGEND

- Line path
  - Flag\_Separation
- Data exceeding max. data spacing: 0.0%





Client:	
Project: Fort Ord- Parker Flats	
Contractor:	
Created by:	Verified by:
Date:	File: 102009-2TA_DATASEP
Page number:	Approved:

# MAP

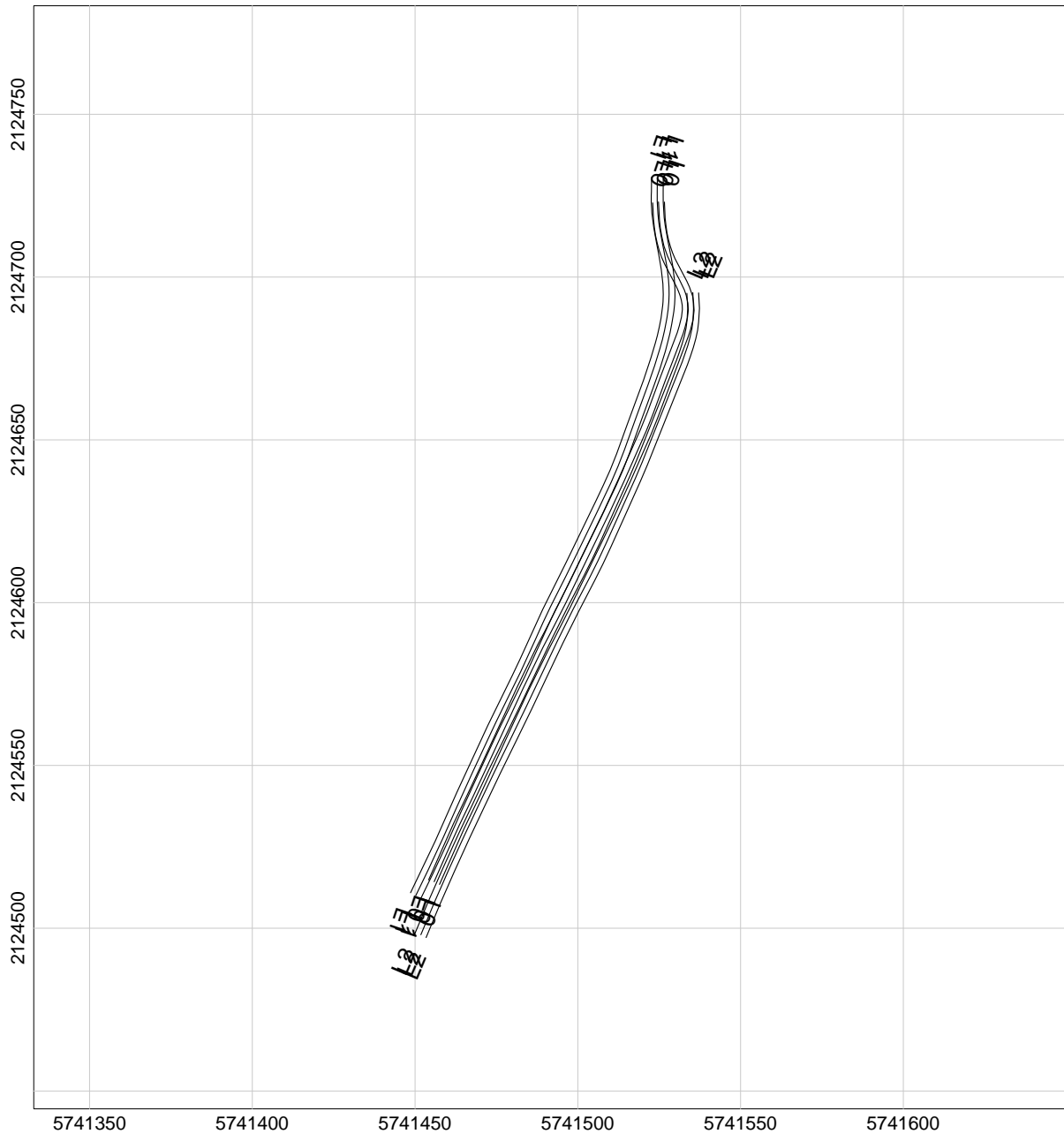
## Sample Separation



### LEGEND

-  Line path
-  Flag\_Separation

Data exceeding max. data spacing: 0.0%



Client:

Project: Fort Ord- Parker Flats

Contractor:

Created by:

Verified by:

Date:

File: 102009-3TA\_DATASEP

Page number:



Approved:

# MAP

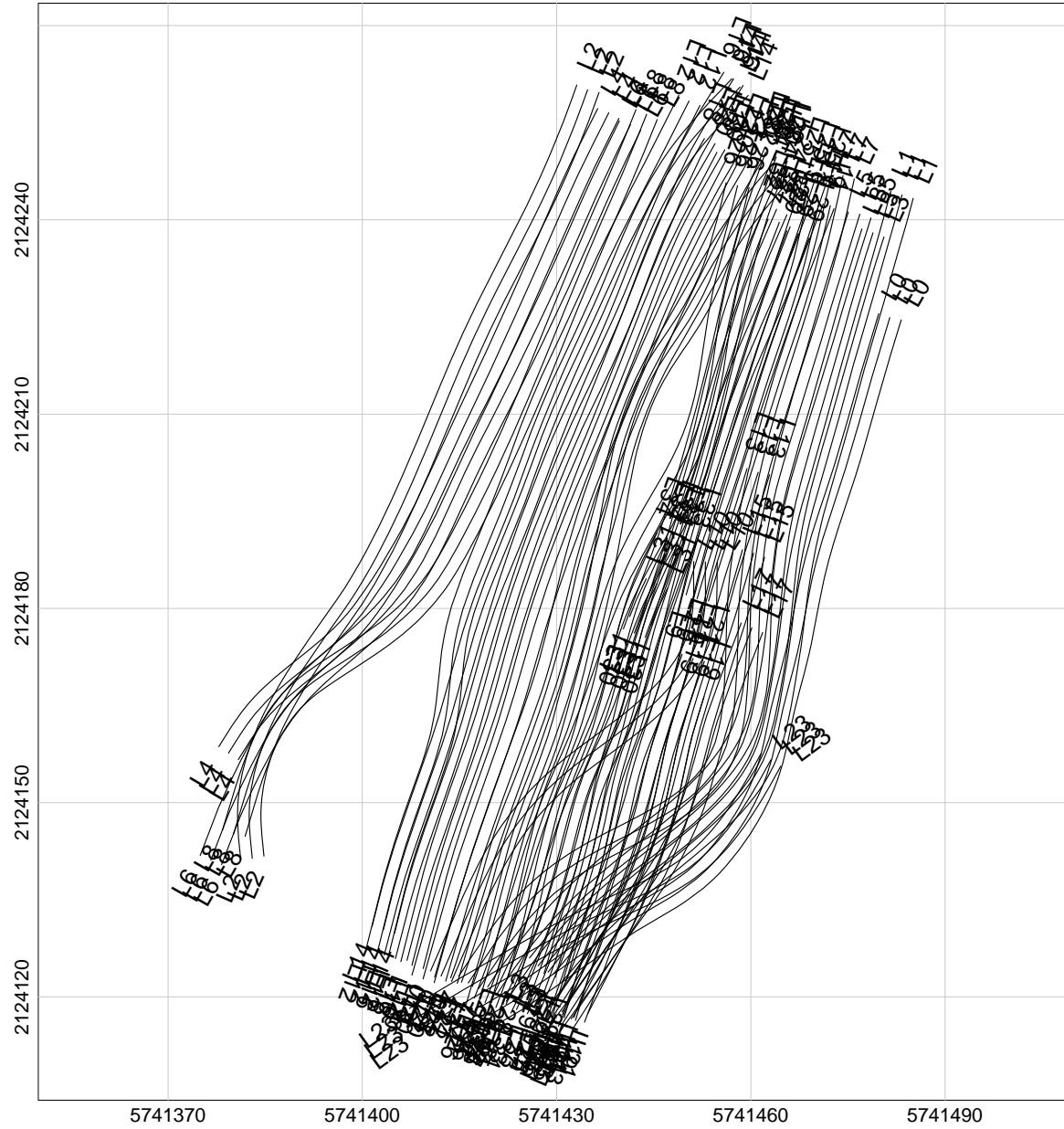
## Sample Separation



### LEGEND

-  Line path
  -  Flag\_Separation
- Data exceeding max. data spacing: 0.0%

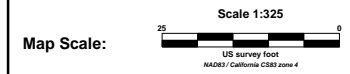

Client:	
Project:	
Contractor:	
Created by:	Verified by:
Date:	File: 102109-1TA_DATASEP
Page number:	Approved:



# MAP

## Sample Separation

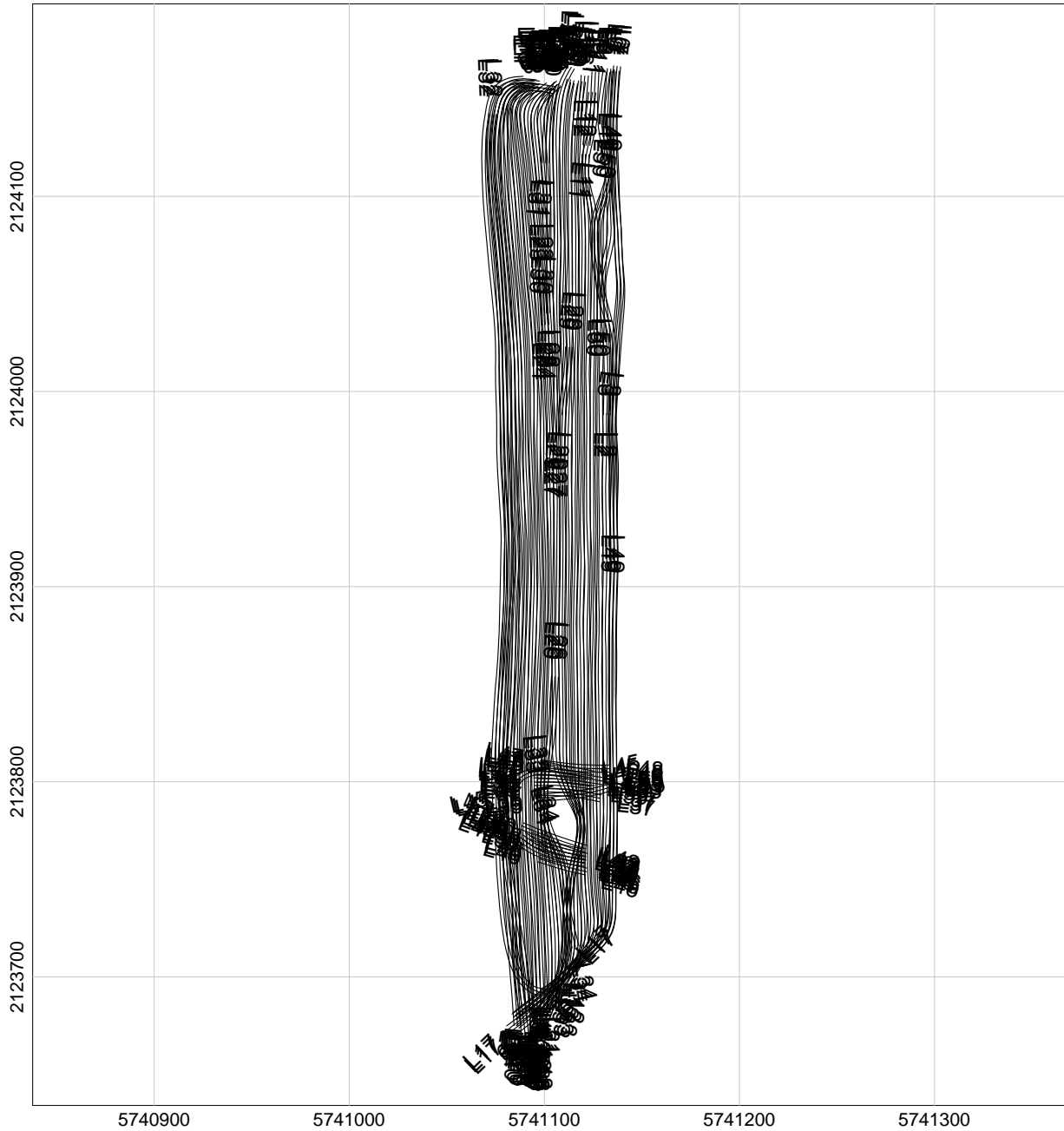

### LEGEND

- Line path
- Flag\_Separation

Data exceeding max. data spacing: 0.0%



Client:	
Project:	
Contractor:	
Created by:	Verified by:
Date:	File: 102109-2TA_DATASEP
Page number:	Approved:

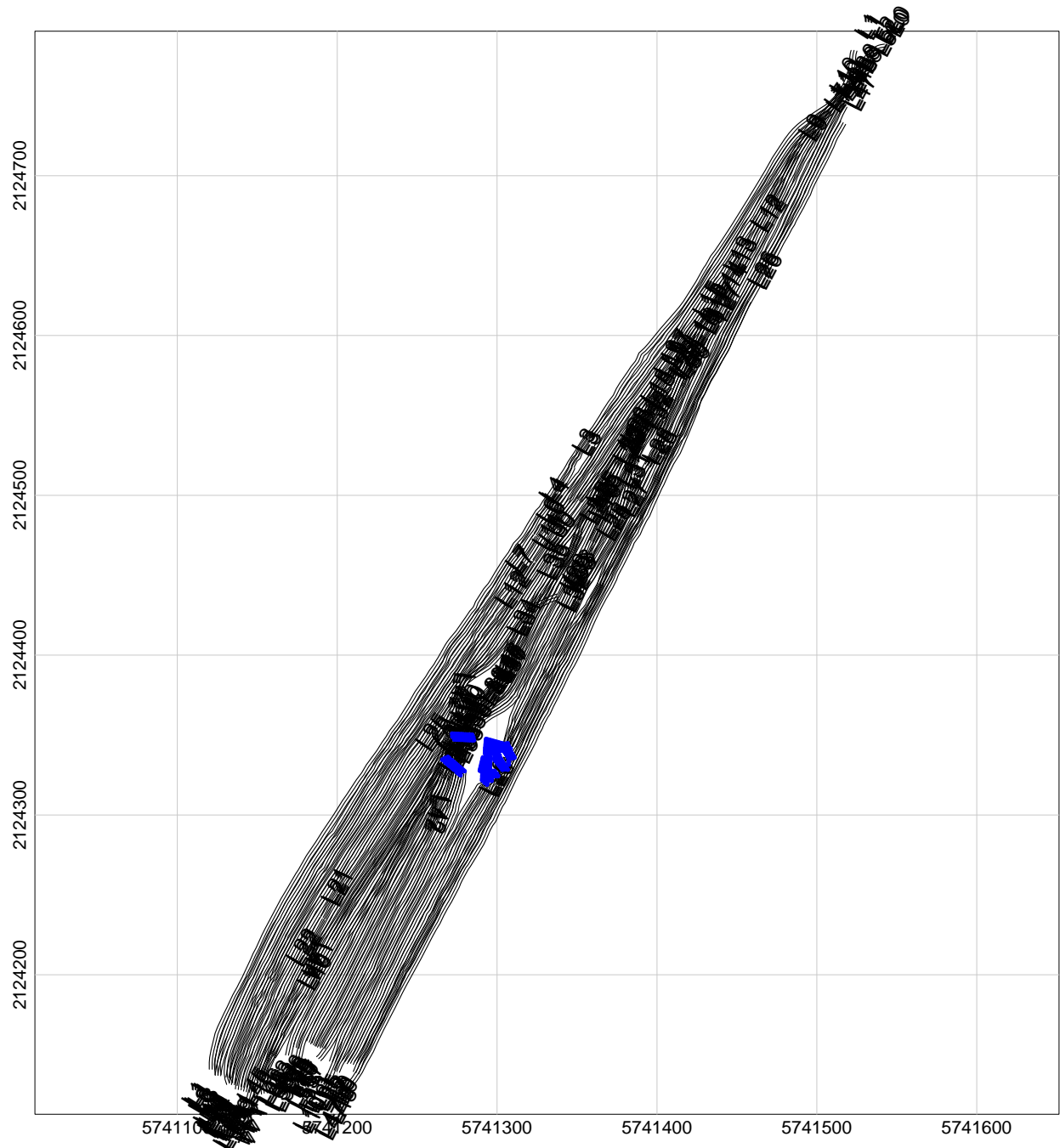

# MAP

## Sample Separation

### LEGEND

- Line path
  - Flag\_Separation
- Data exceeding max. data spacing: 0.3%



Client:	
Project:	
Contractor:	
Created by:	Verified by:
Date:	File: 102109-3TA_DATASEP
Page number:	Approved:

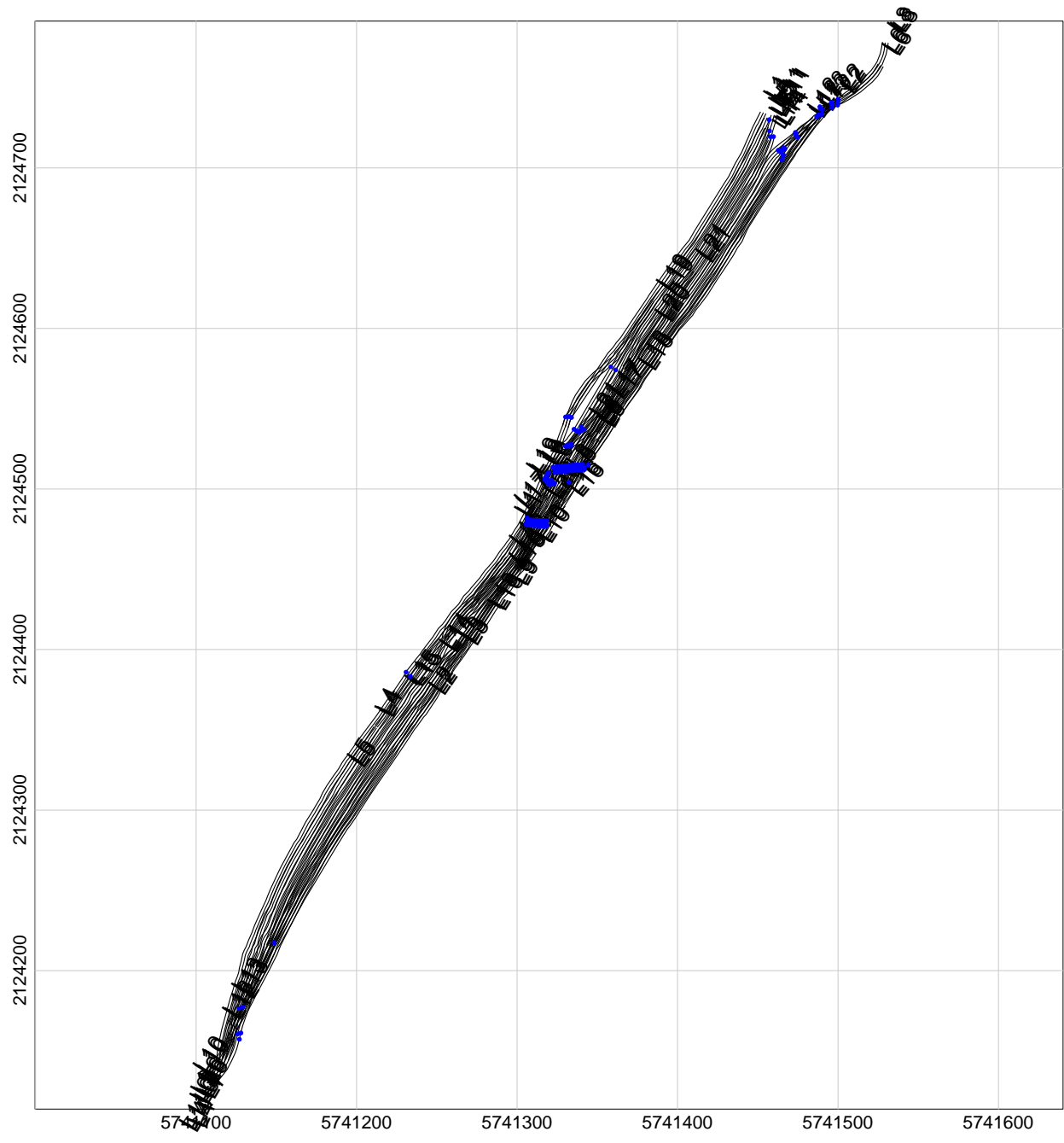

# MAP

## Sample Separation

### LEGEND

-  Line path
  -  Flag\_Separation
- Data exceeding max. data spacing: 0.2%



Client:	
Project:	
Contractor:	
Created by:	Verified by:
Date:	File: 102209-1TA_DATASEP
Page number:	Approved:

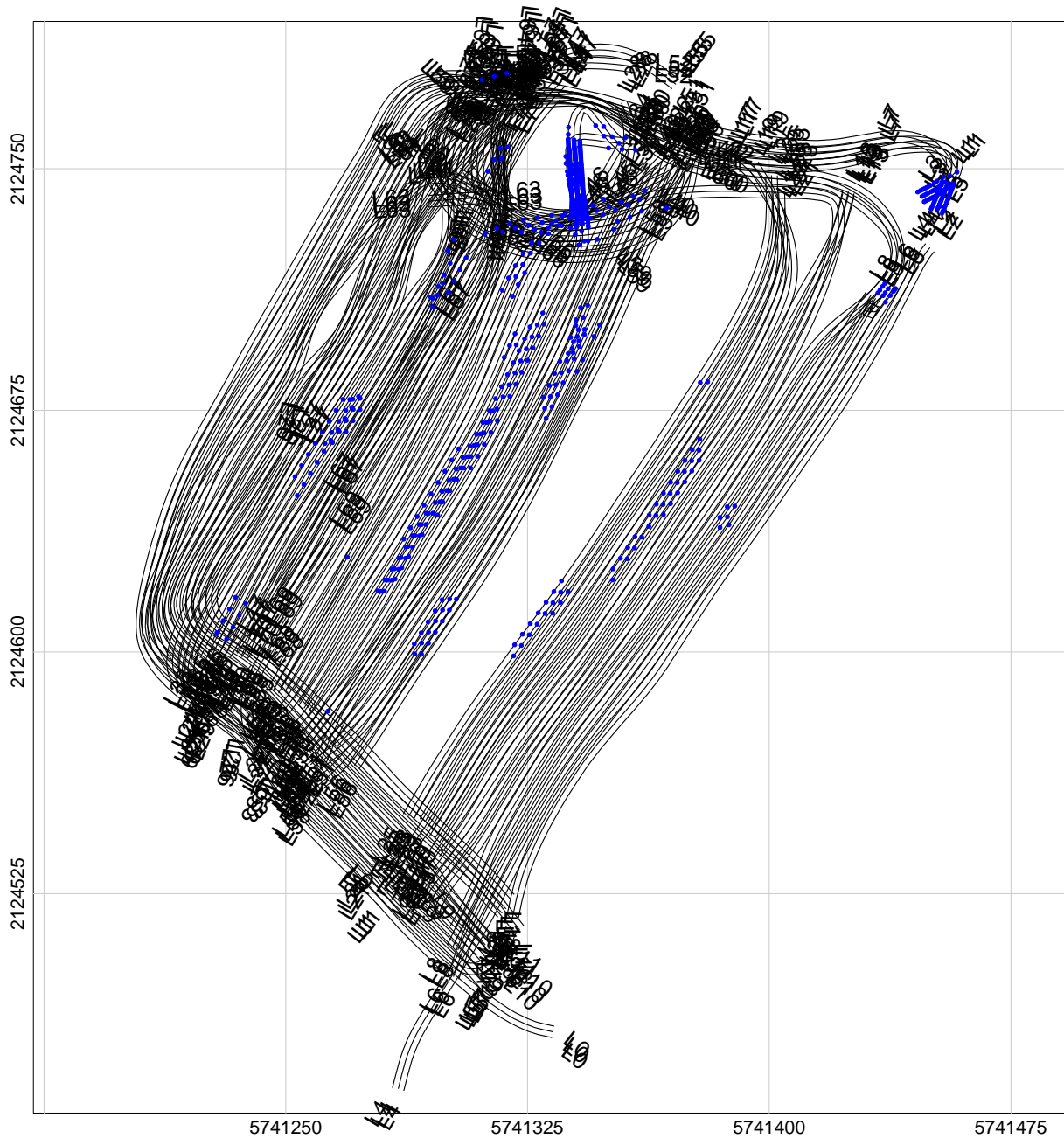

# MAP

## Sample Separation

### LEGEND

-  Line path
-  Flag\_Separation

Data exceeding max. data spacing: 0.4%





Client:	
Project:	
Contractor:	
Created by:	Verified by:
Date:	File: 102209-2TA_DATASEP
Page number:	Approved:

# MAP

## Sample Separation

### LEGEND

-  Line path
-  Flag\_Separation

Data exceeding max. data spacing: 0.0%

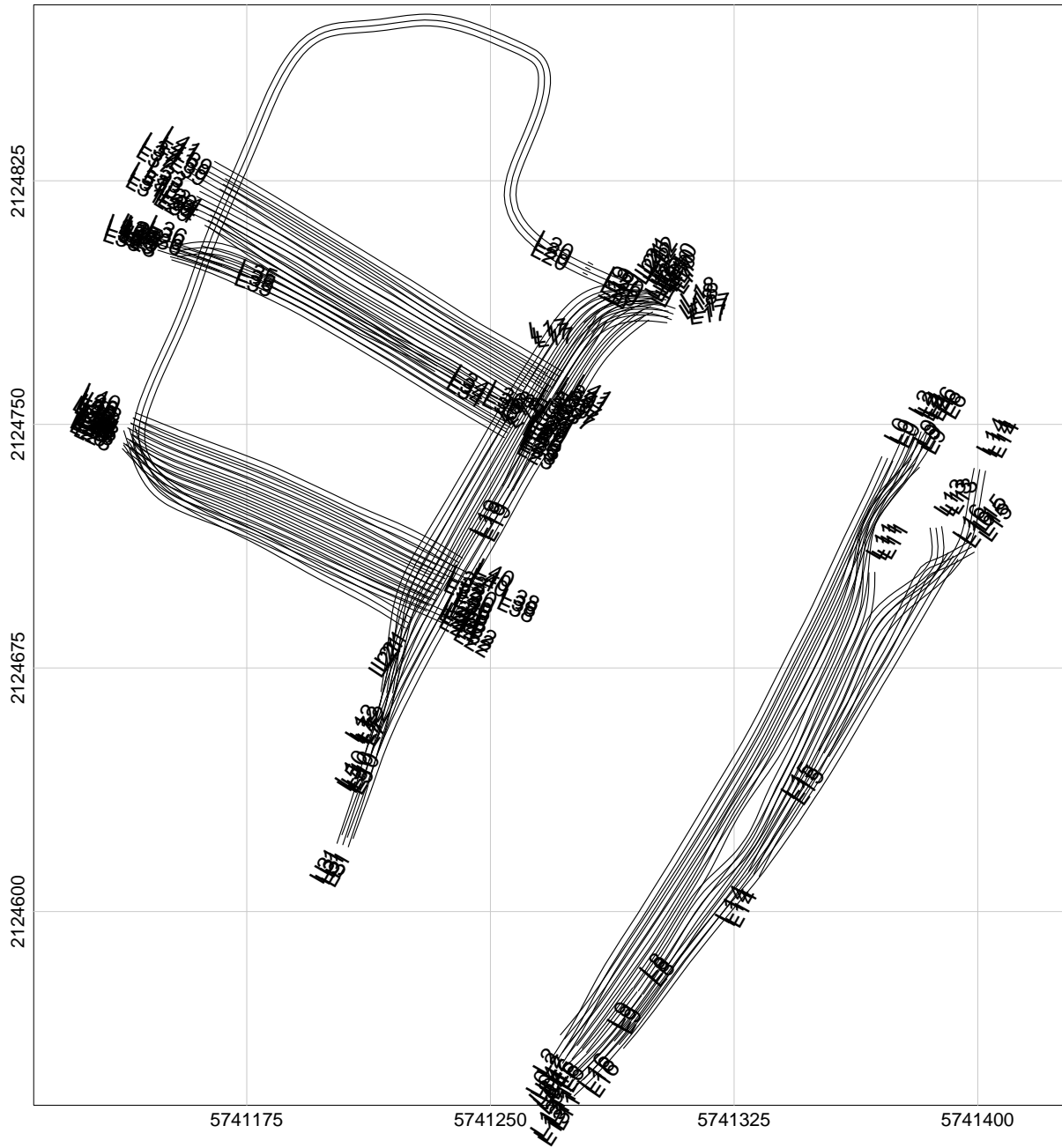



Client:	
Project:	
Contractor:	
Created by:	Verified by:
Date:	File: 102309-1TA_DATASEP
Page number:	Approved:

# MAP

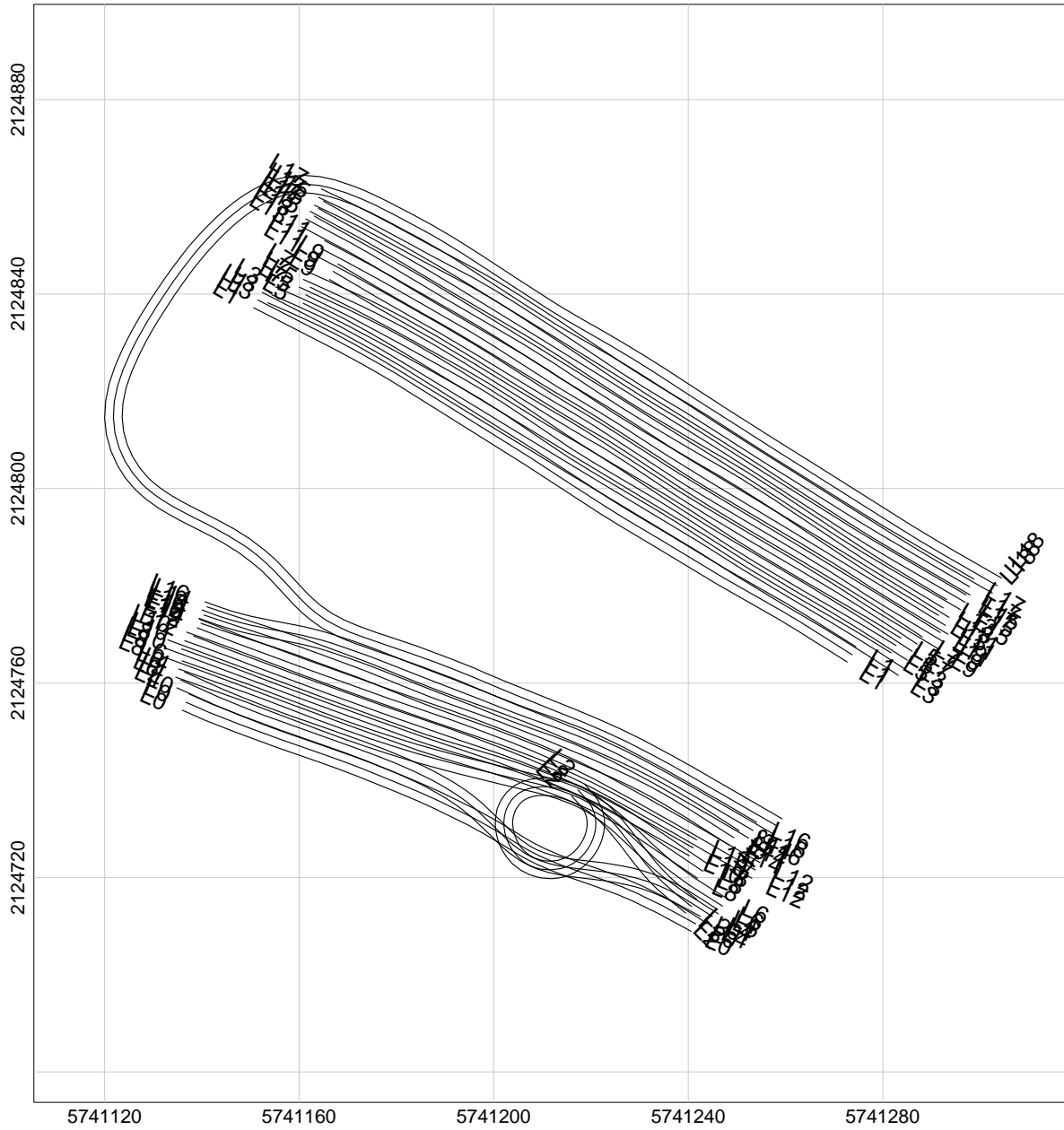
## Sample Separation



### LEGEND

-  Line path
-  Flag Separation

Data exceeding max. data spacing: 0.0%

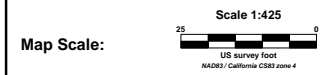

Client:

Project:

Contractor:

Created by:

Verified by:

Date:

File: 102309-2TA\_DATASEP

Page number:

Approved:

# MAP

## Sample Separation

### LEGEND

-  Line path
  -  Flag\_Separation
- Data exceeding max. data spacing: 0.1%

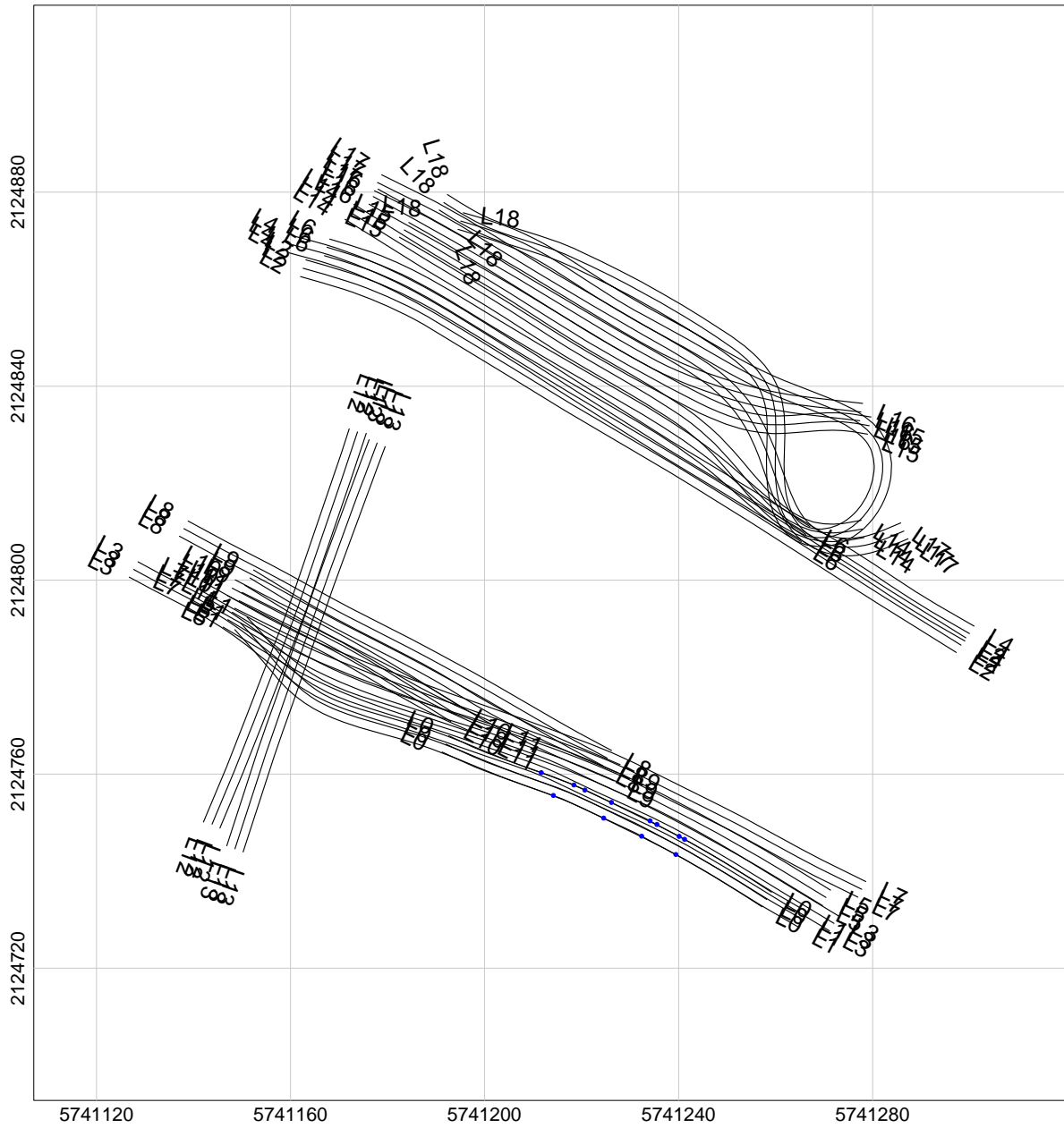
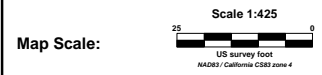



Client:	
Project:	
Contractor:	
Created by:	Verified by:
Date:	File: 102309-3TA_DATASEP
Page number:	Approved:

# MAP

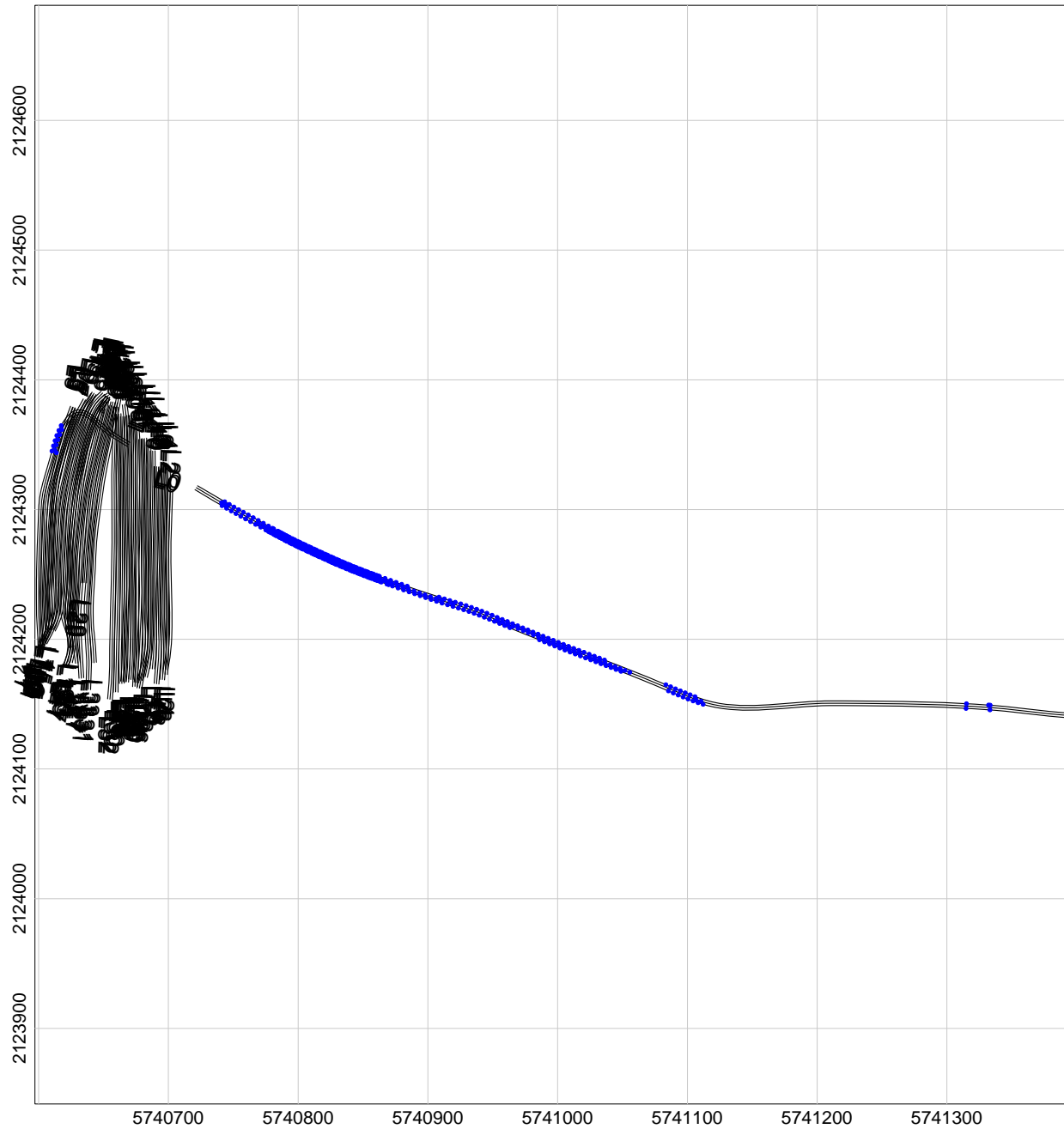
## Sample Separation



### LEGEND

-  Line path
  -  Flag\_Separation
- Data exceeding max. data spacing: 0.6%

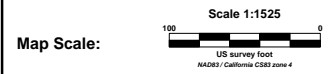

Client:	
Project:	
Contractor:	
Created by:	Verified by:
Date:	File: 102309-4TA_DATASEP
Page number:	Approved:



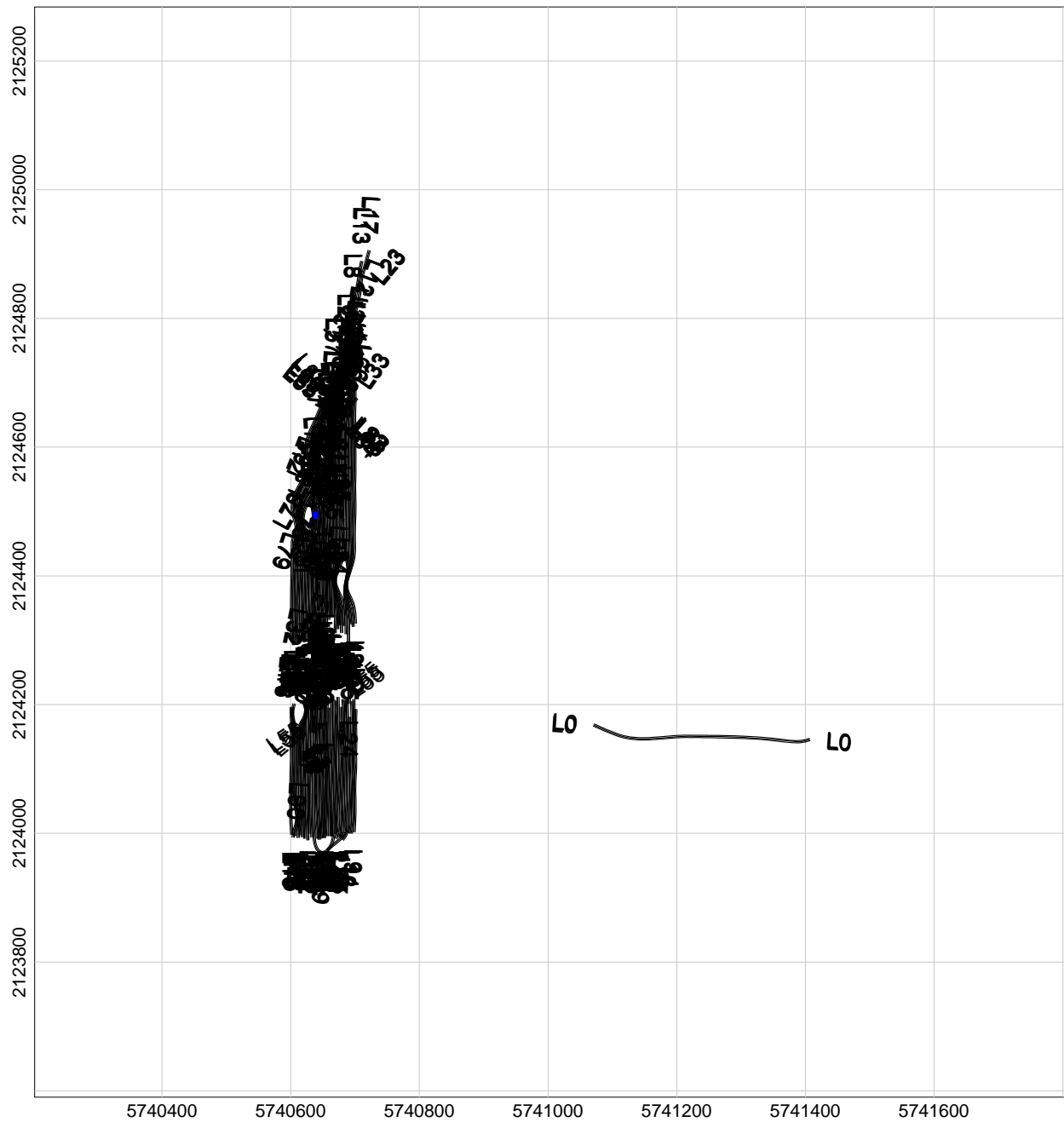



# MAP

## Sample Separation

### LEGEND

-  Line path
  -  Flag\_Separation
- Data exceeding max. data spacing: 0.0%

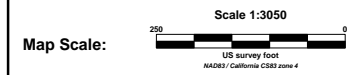

Client:	
Project:	
Contractor:	
Created by:	Verified by:
Date:	File: 102609-1TA_DATASEP
Page number:	Approved:

# MAP

## Sample Separation

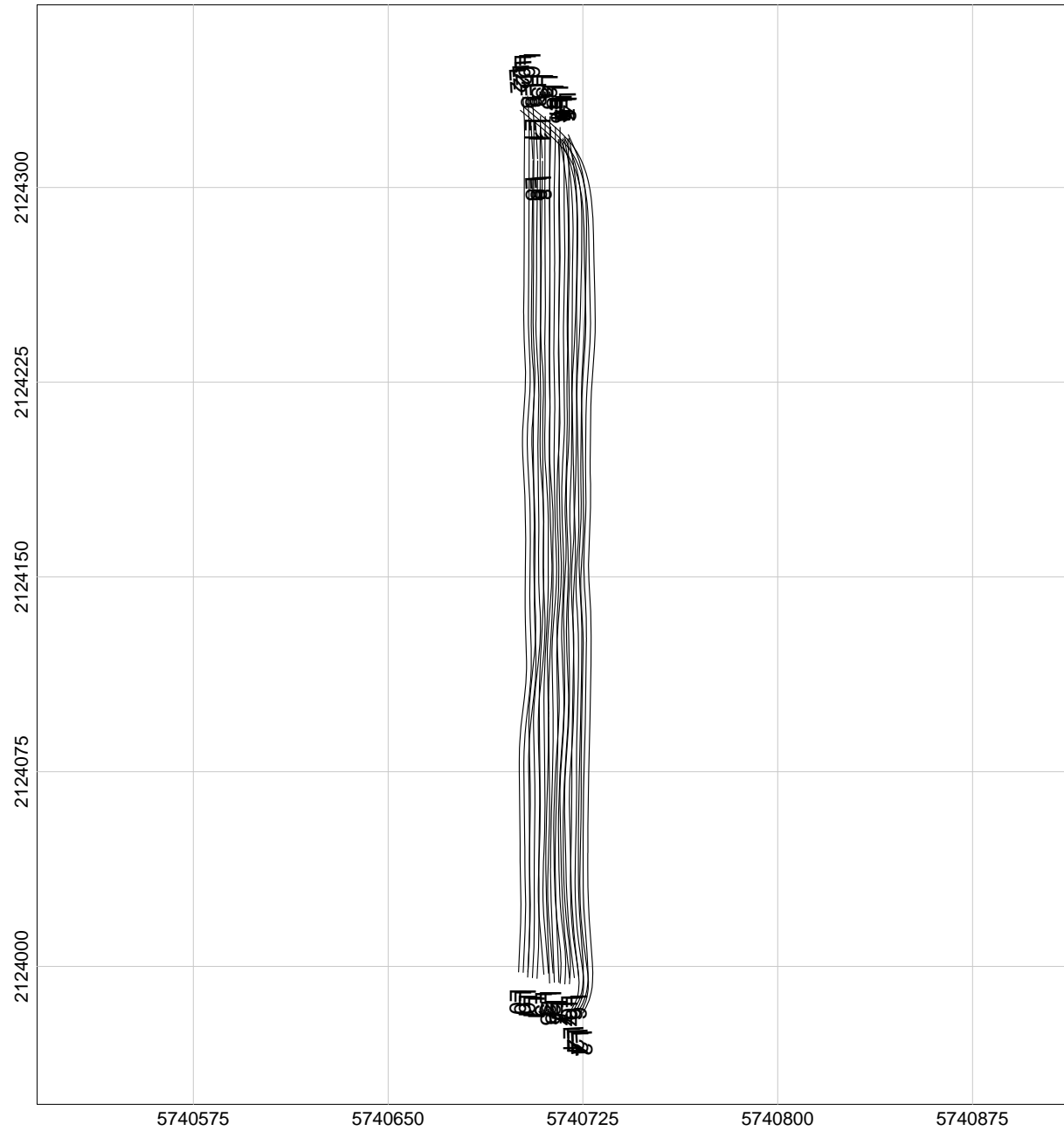

### LEGEND

- Line path
- Flag\_Separation

Data exceeding max. data spacing: 0.0%

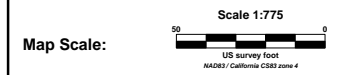



Client:	
Project:	
Contractor:	
Created by:	Verified by:
Date:	File: 102609-2TA_DATASEP
Page number:	Approved:

# MAP

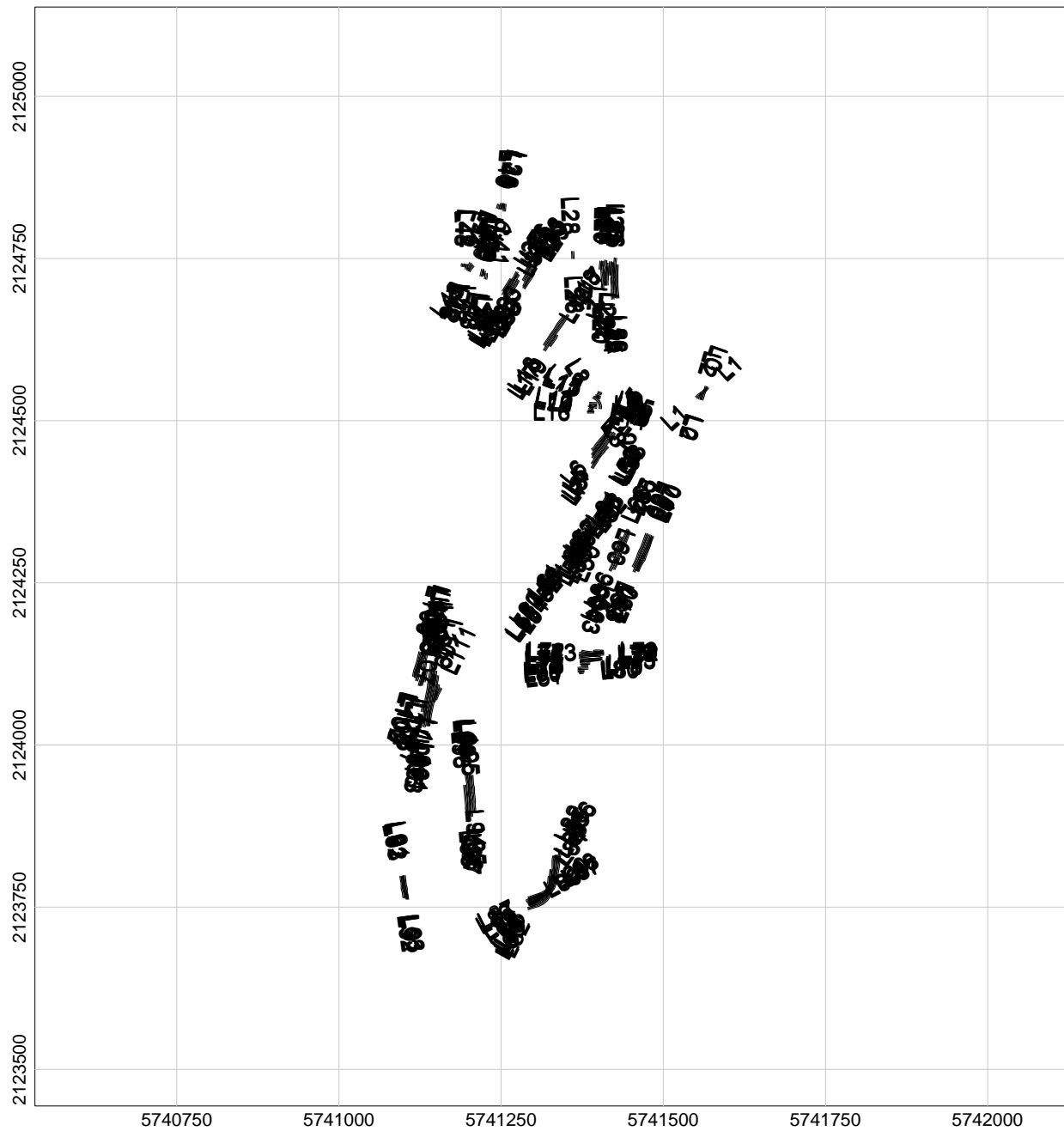
## Sample Separation



### LEGEND

-  Line path
  -  Flag\_Separation
- Data exceeding max. data spacing: 0.0%

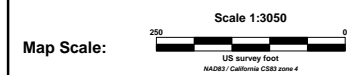

Client:	
Project:	
Contractor:	
Created by:	Verified by:
Date:	File: 102709-1TA_DATASEP
Page number:	Approved:

# MAP

## Sample Separation

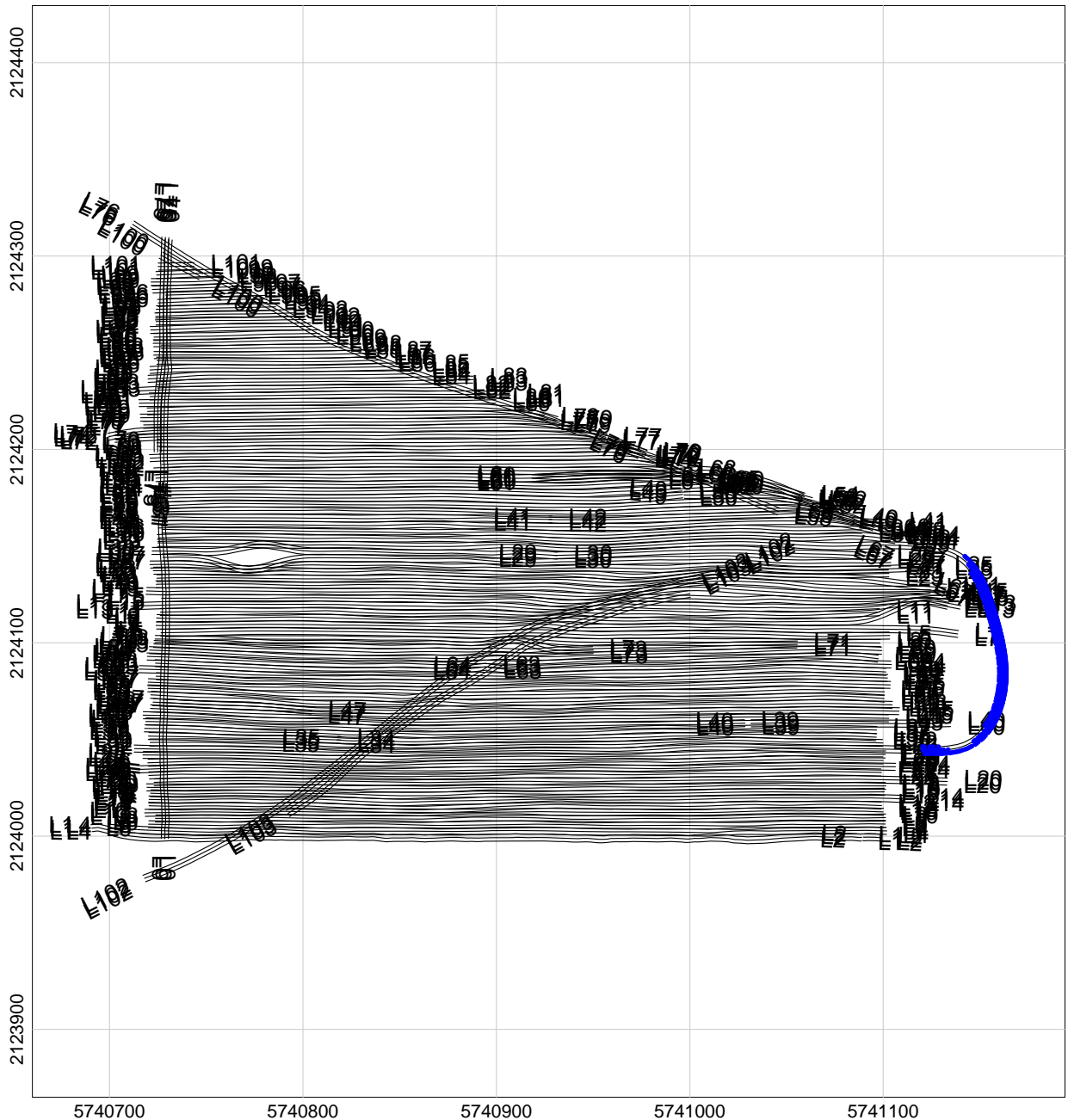

### LEGEND

- Line path
  - ..... Flag\_Separation
- Data exceeding max. data spacing: 0.2%





Client:	
Project:	
Contractor:	
Created by:	Verified by:
Date:	File: 102709-2TA_DATASEP
Page number:	Approved:

# MAP

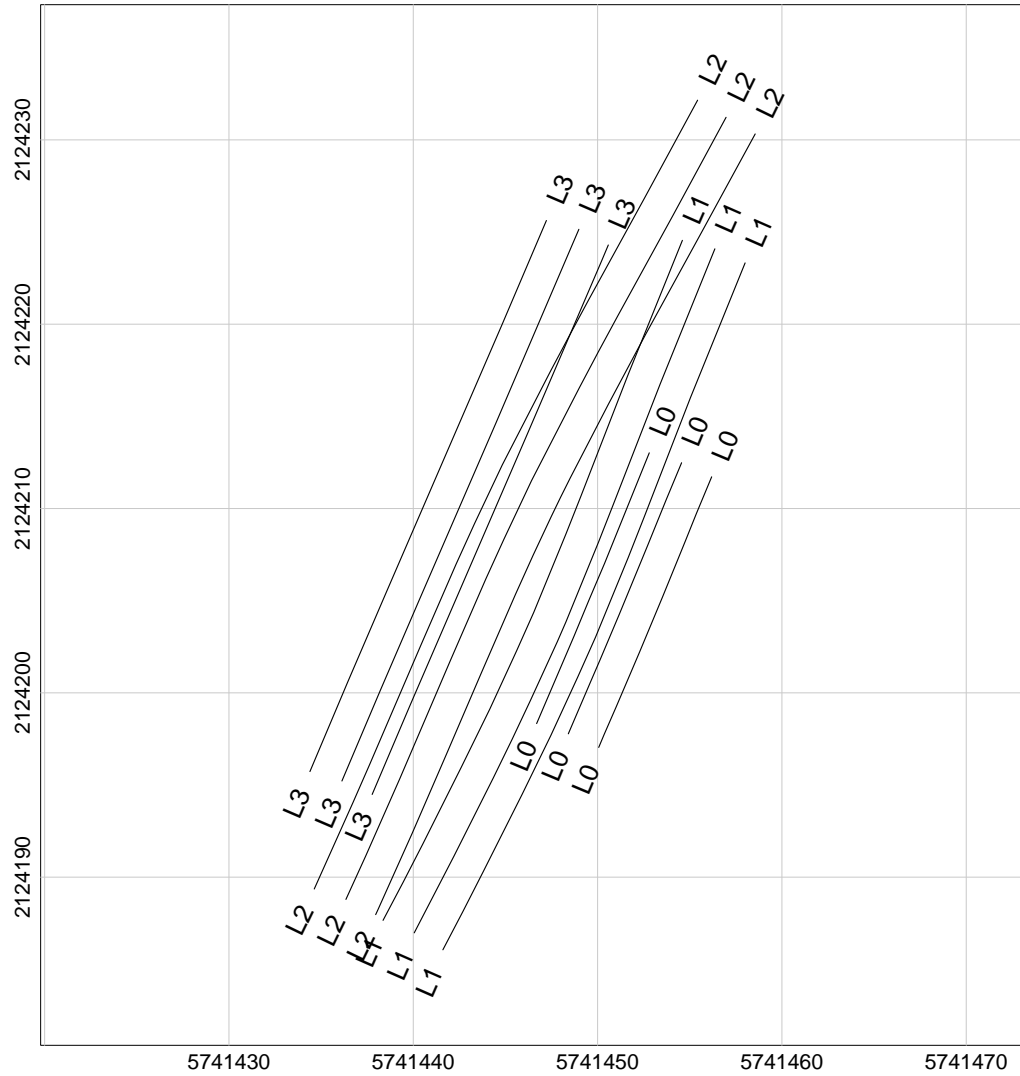
## Sample Separation



### LEGEND

-  Line path
  -  Flag\_Separation
- Data exceeding max. data spacing: 0.0%



Client:	
Project:	
Contractor:	
Created by:	Verified by:
Date:	File: 102809-1TA_DATASEP
Page number:	Approved:

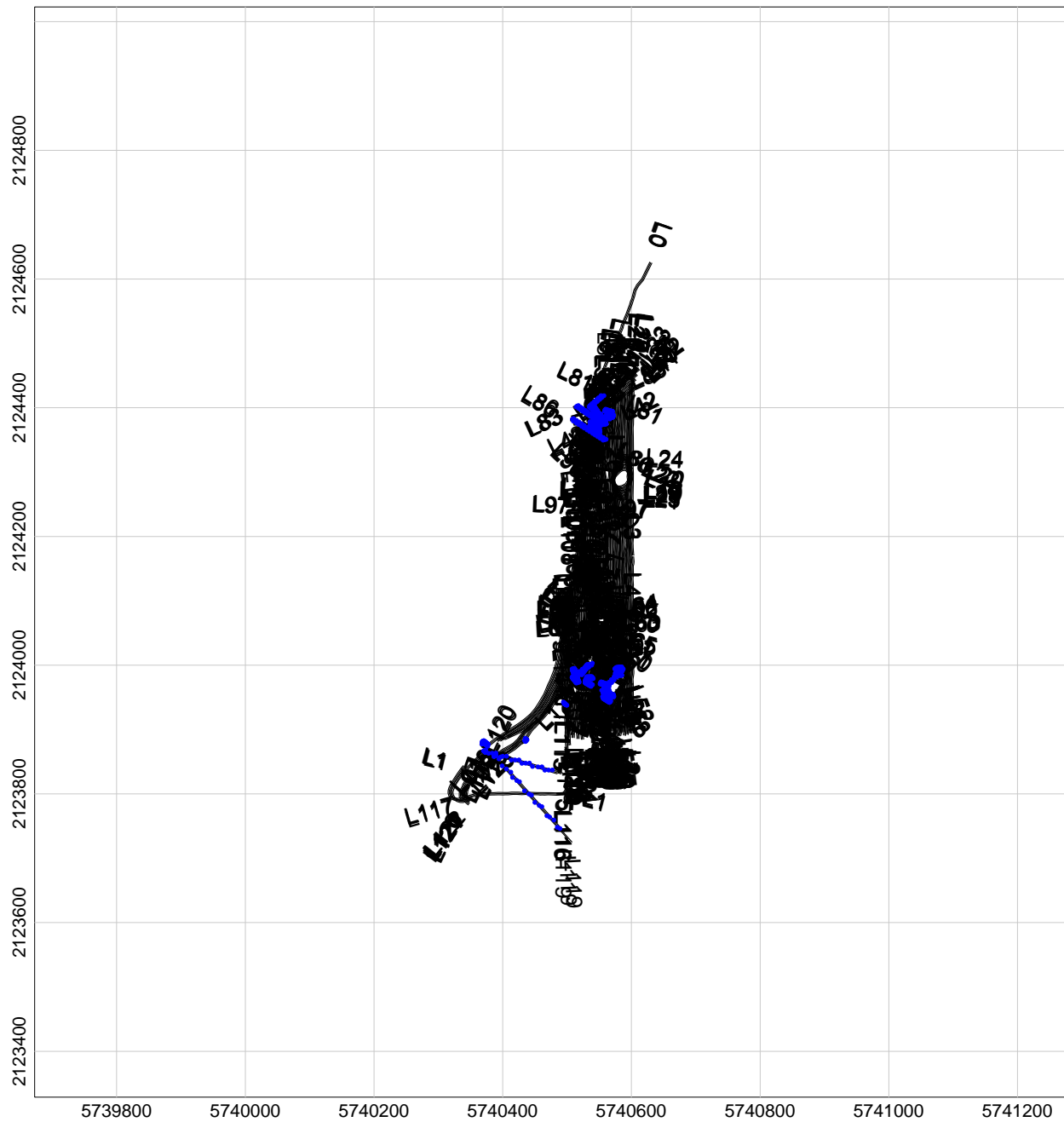

# MAP

## Sample Separation

### LEGEND

-  Line path
-  Flag\_Separation

Data exceeding max. data spacing: 0.6%

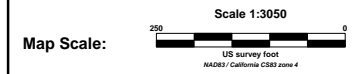



Client:	
Project:	
Contractor:	
Created by:	Verified by:
Date:	File: 102809-2TA_DATASEP
Page number:	Approved:

# MAP

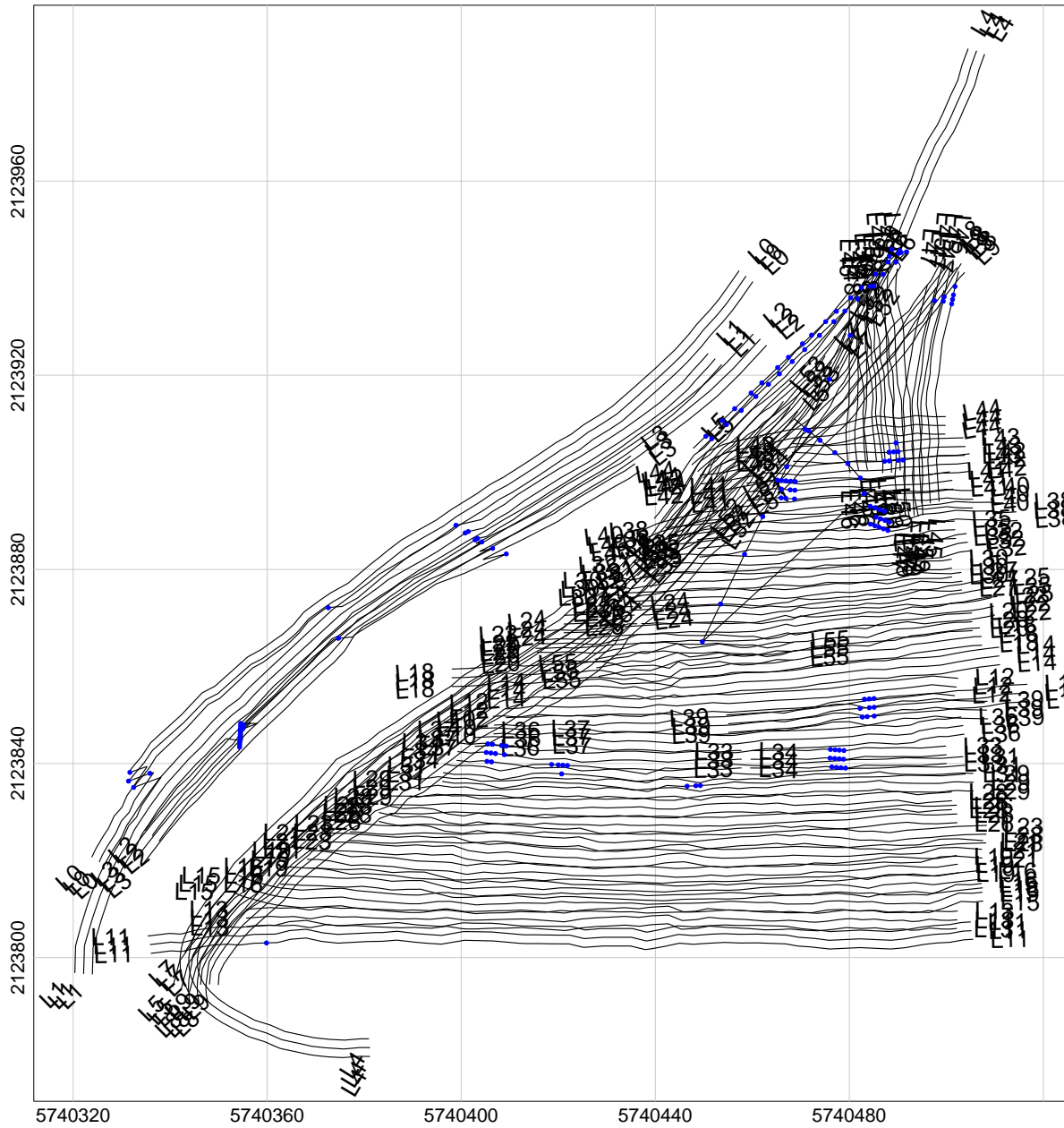
## Sample Separation



### LEGEND

-  Line path
-  Flag\_Separation

Data exceeding max. data spacing: 0.3%



Client:	
Project:	
Contractor:	
Created by:	Verified by:
Date:	File: 102809-3TA_DATASEP
Page number:	Approved:

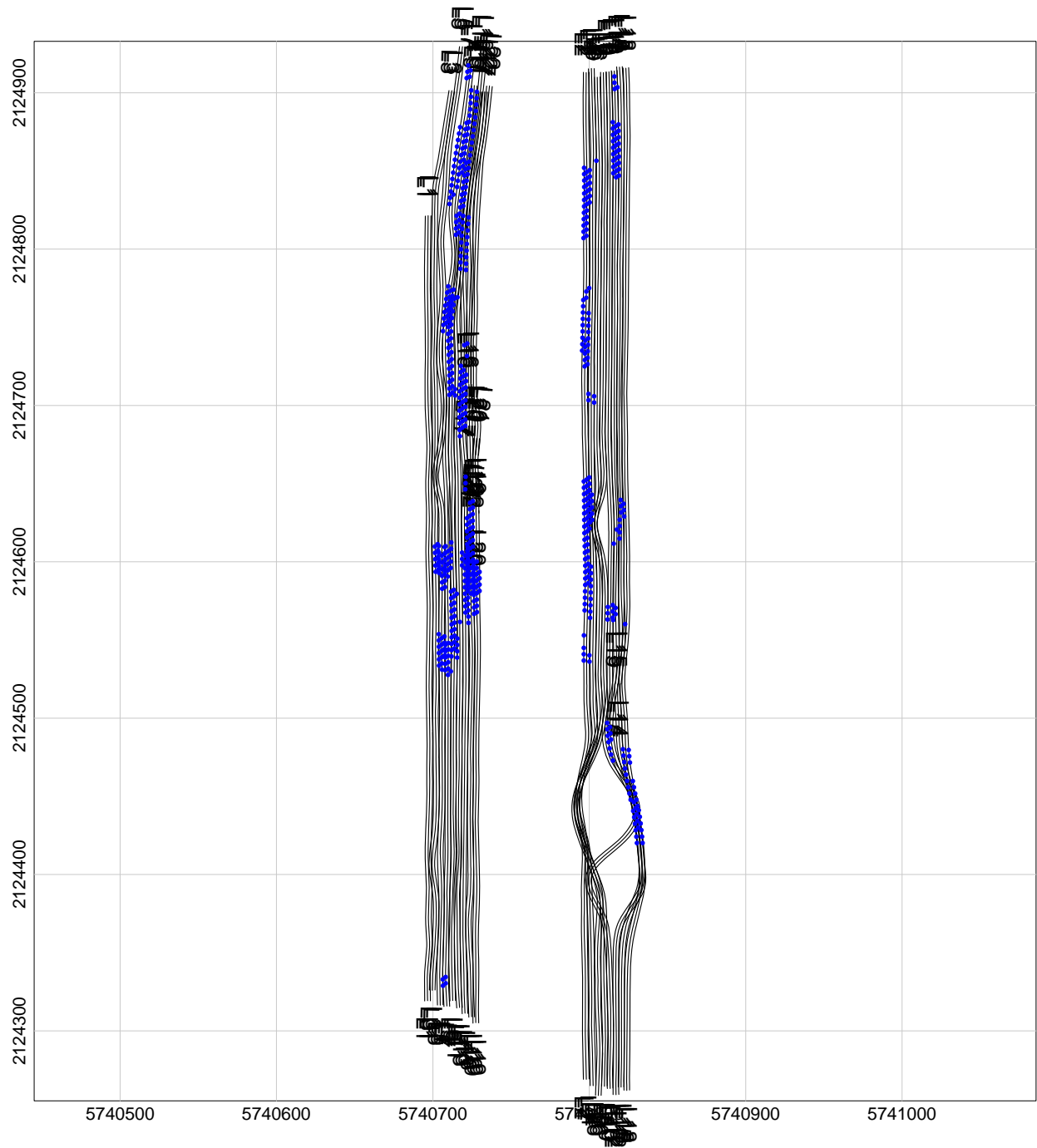

# MAP

## Sample Separation

### LEGEND

-  Line path
  -  Flag\_Separation
- Data exceeding max. data spacing: 0.7%

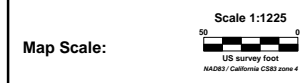

Client:	
Project:	
Contractor:	
Created by:	Verified by:
Date:	File: 102909-1TA_DATASEP
Page number:	Approved:



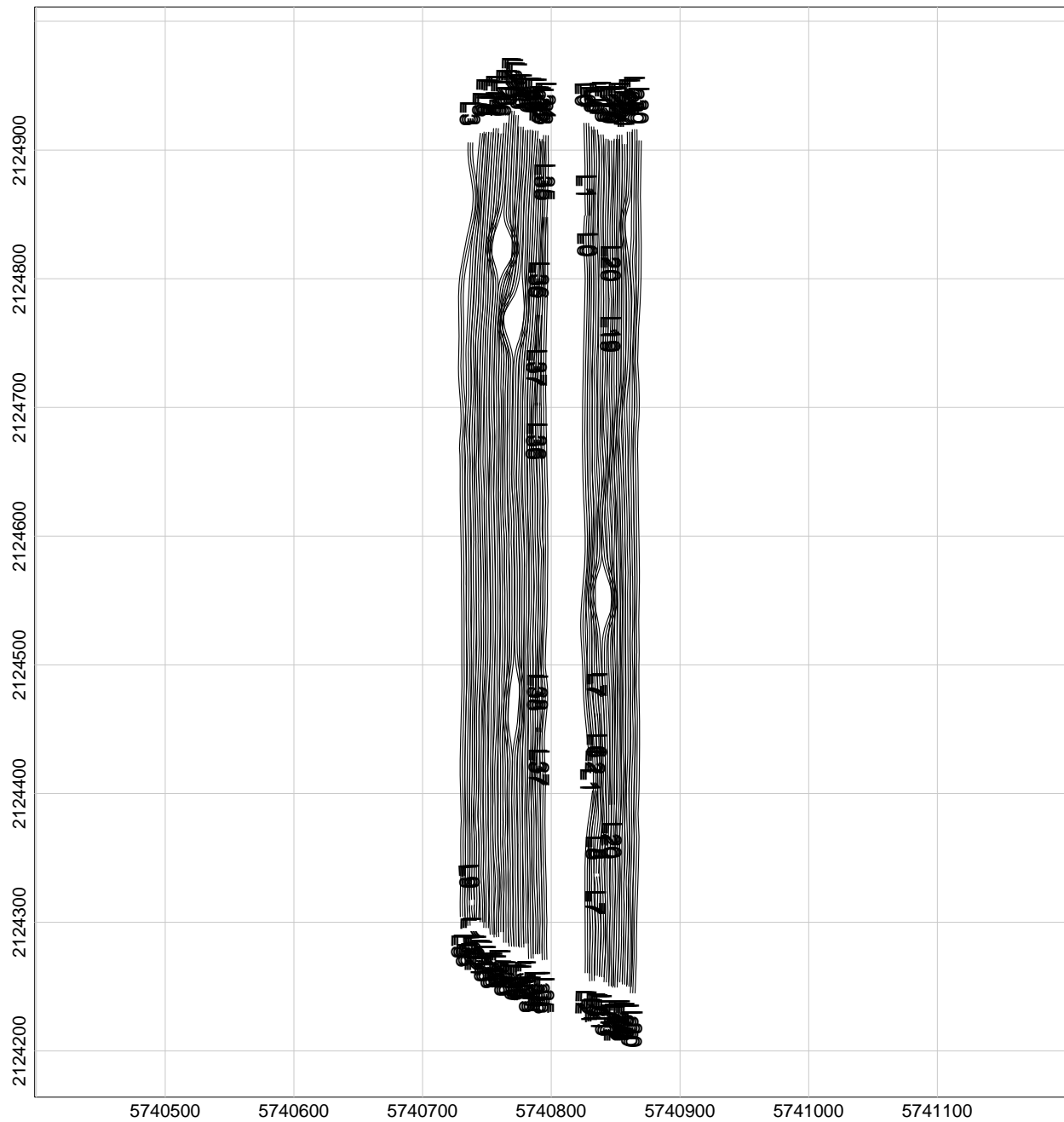



# MAP

## Sample Separation

### LEGEND

-  Line path
-  Flag\_Separation

Data exceeding max. data spacing: 0.0%

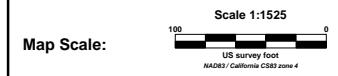

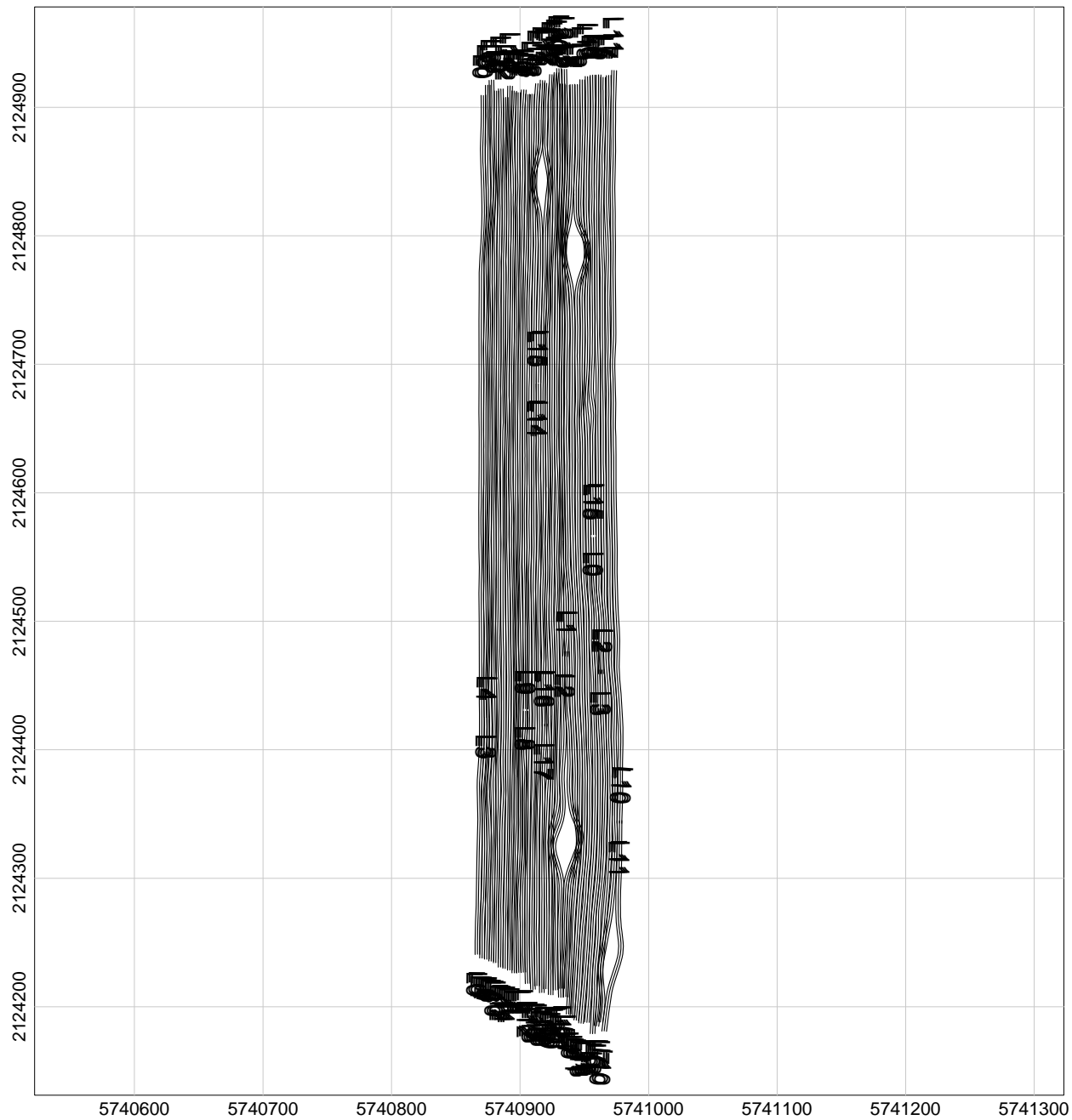

Client:	
Project:	
Contractor:	
Created by:	Verified by:
Date:	File: 102909-2TA_DATASEP
Page number:	Approved:



# MAP

## Sample Separation

### LEGEND

-  Line path
-  Flag\_Separation

Data exceeding max. data spacing: 0.0%

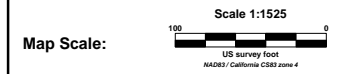

Client:	
Project:	
Contractor:	
Created by:	Verified by:
Date:	File: 103009-1TA_DATASEP
Page number:	Approved:

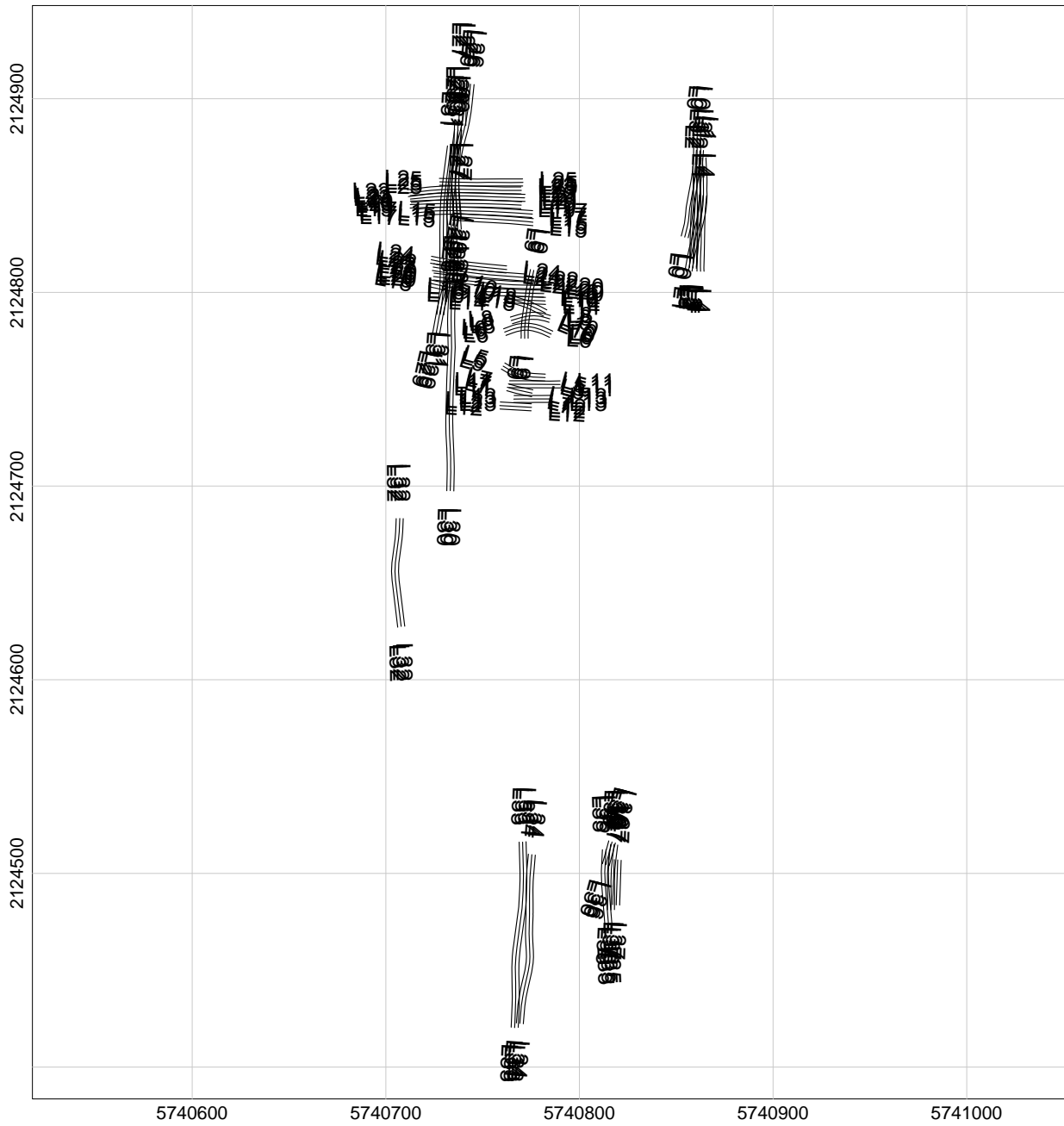

# MAP

## Sample Separation

### LEGEND

-  Line path
  -  Flag\_Separation
- Data exceeding max. data spacing: 0.0%



Client:	
Project:	
Contractor:	
Created by:	Verified by:
Date:	File: 103009-2TA_DATASEP
Page number:	Approved:

# MAP

## Sample Separation

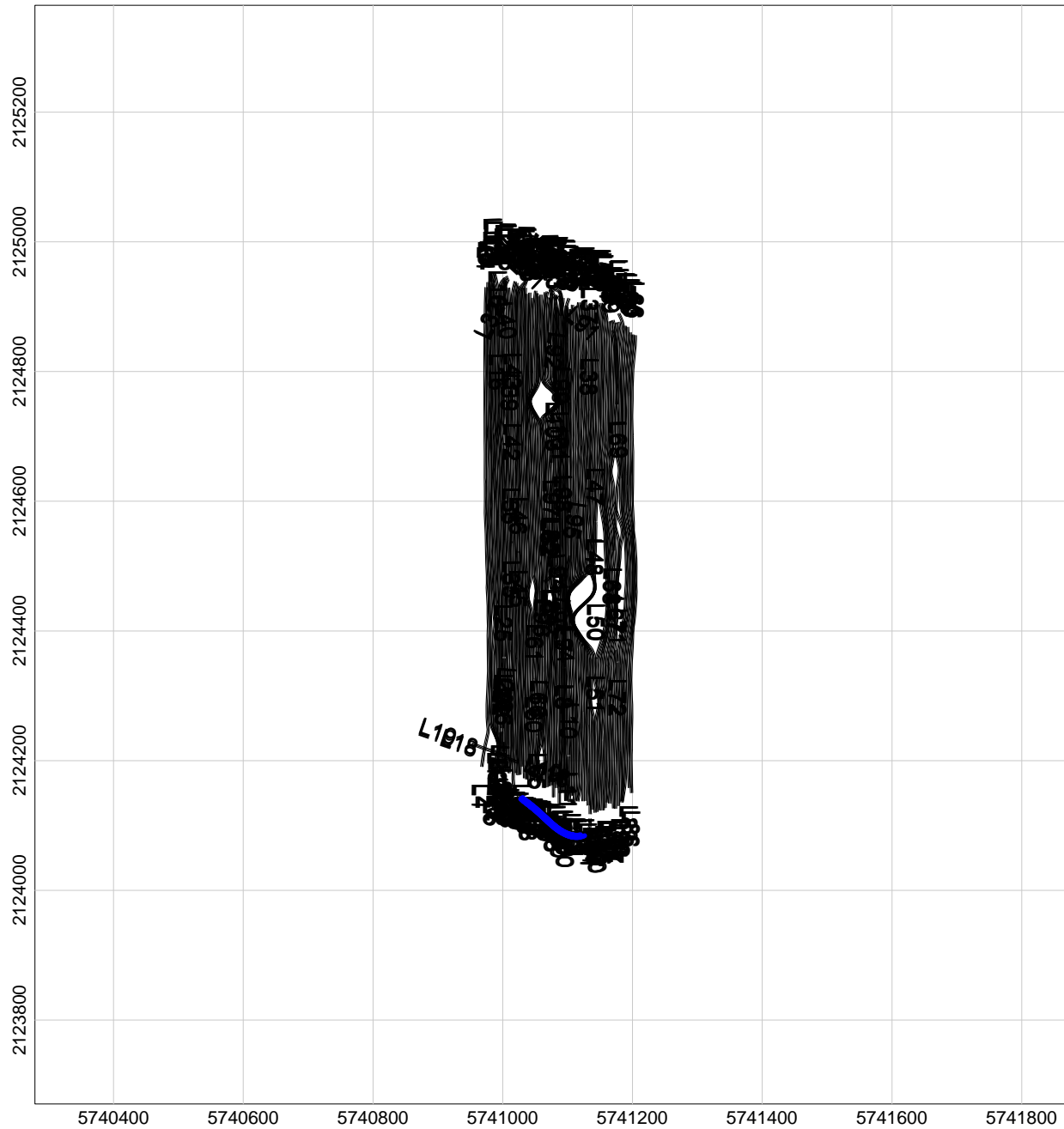

### LEGEND

- Line path
- ..... Flag\_Separation

Data exceeding max. data spacing: 0.1%

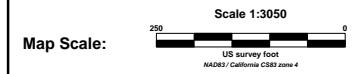

Client:	
Project:	
Contractor:	
Created by:	Verified by:
Date:	File: 110209-1TA_DATASEP
Page number:	Approved:

# MAP

## Sample Separation

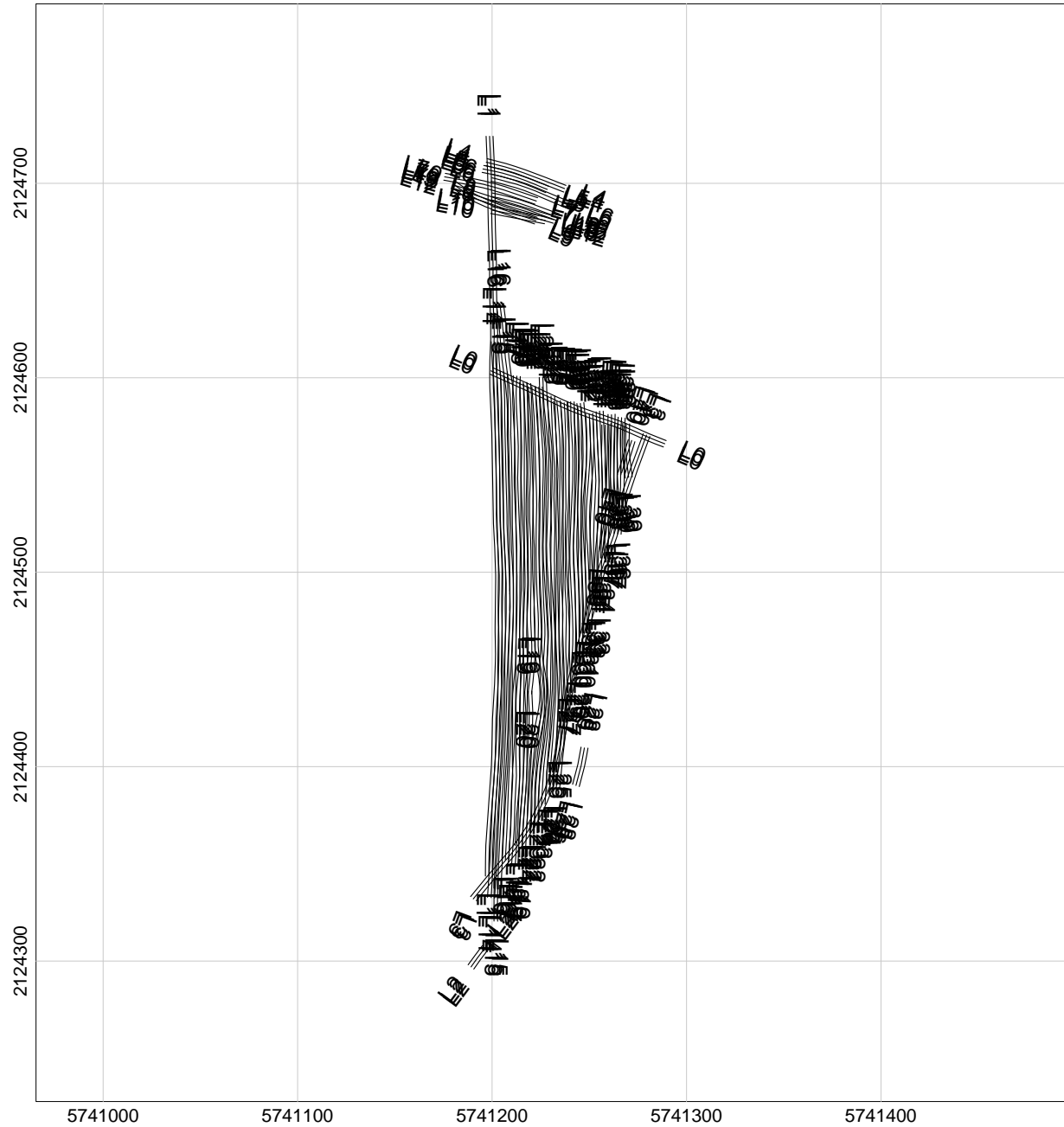

### LEGEND

- Line path
  - Flag\_Separation
- Data exceeding max. data spacing: 0.0%

Map Scale:  Scale 1:1025  
US survey foot  
 NAD83 / California CSRS zone 4

 N  
 Grid North: 0°0'0"  
 Mag North: 0°0'0"



Client:	
Project:	
Contractor:	
Created by:	Verified by:
Date:	File: 110309-1TA_DATASEP
Page number:	Approved:

# MAP

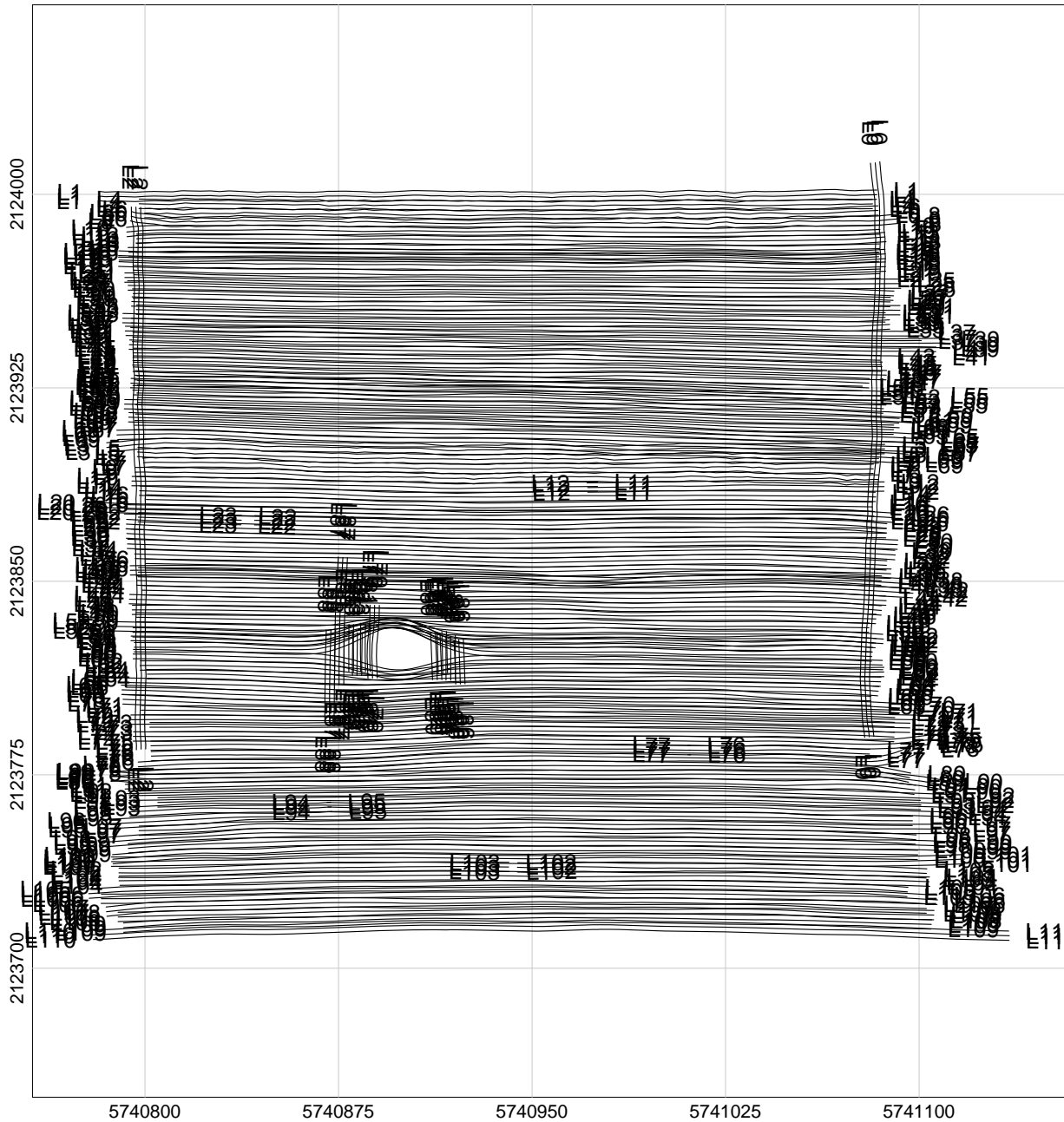
## Sample Separation



### LEGEND

-  Line path
  -  Flag\_Separation
- Data exceeding max. data spacing: 0.0%

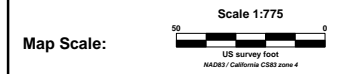



Client:	
Project:	
Contractor:	
Created by:	Verified by:
Date:	File: 110309-2TA_DATASEP
Page number:	Approved:

# MAP

## Sample Separation

### LEGEND

-  Line path
  -  Flag\_Separation
- Data exceeding max. data spacing: 0.5%

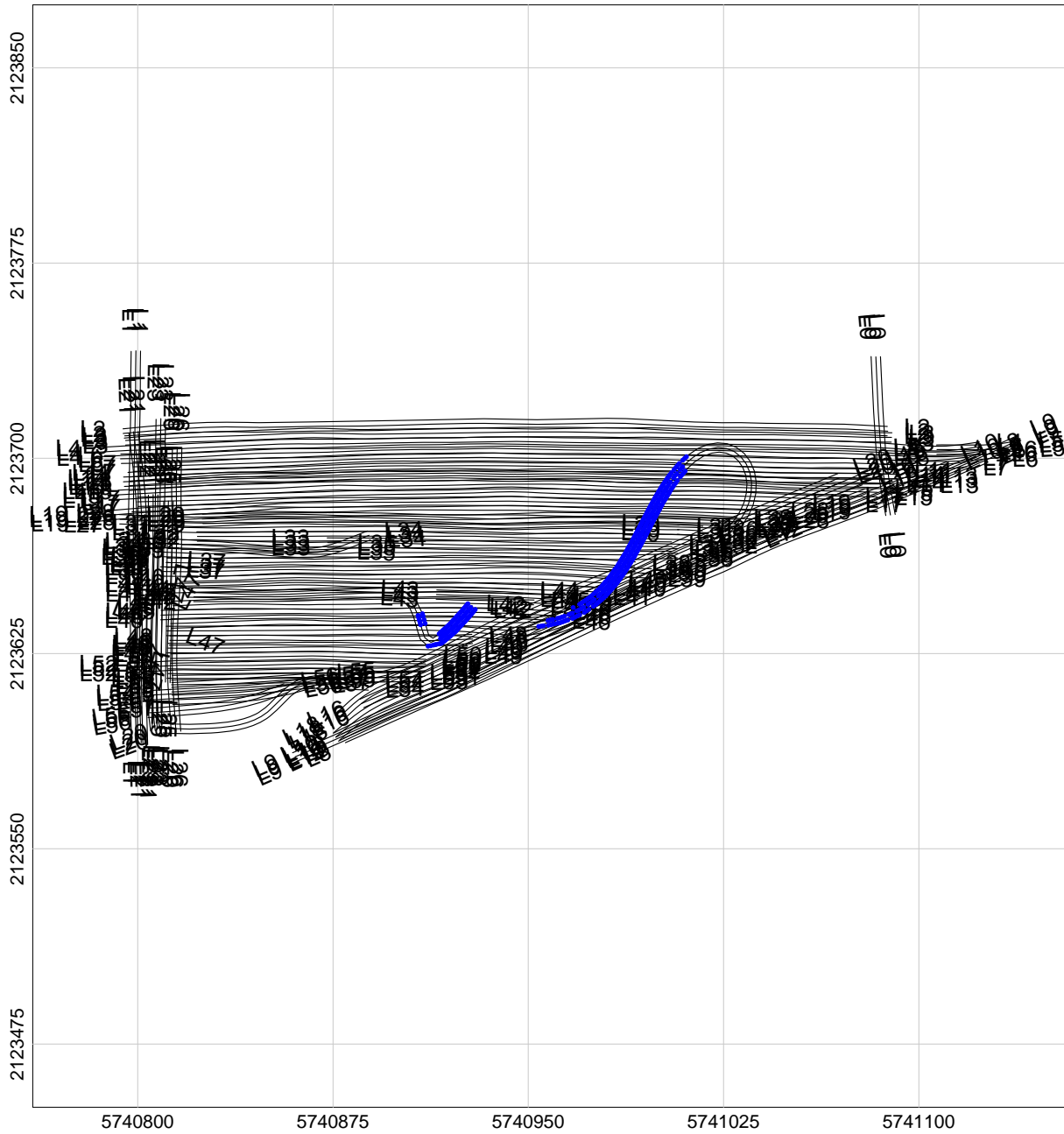
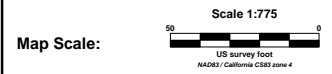

Client:	
Project:	
Contractor:	
Created by:	Verified by:
Date:	File: 110409-1TA_DATASEP
Page number:	Approved:

# MAP

## Sample Separation

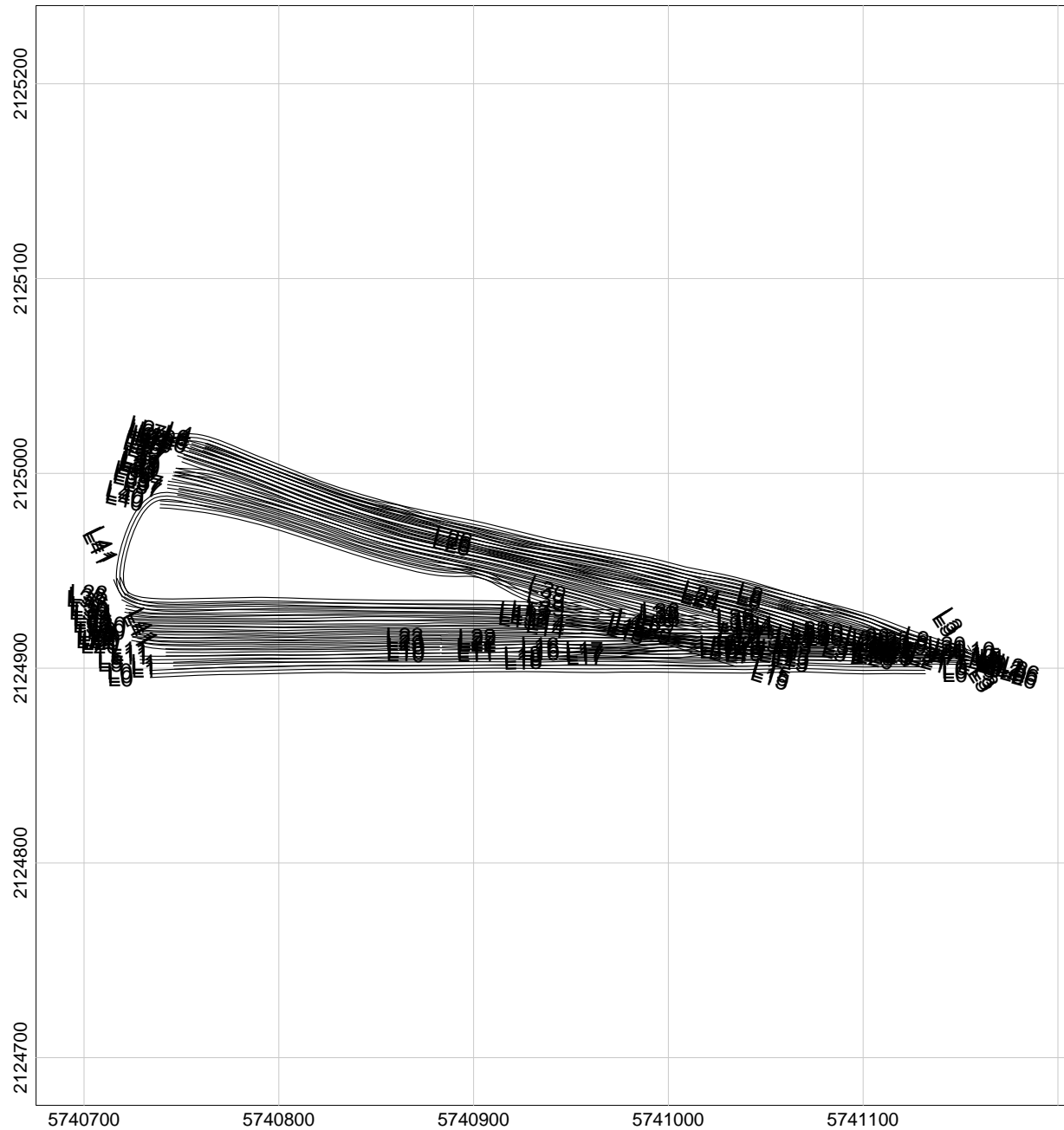

### LEGEND

- Line path
- Flag\_Separation

Data exceeding max. data spacing: 0.0%



Client:	
Project:	
Contractor:	
Created by:	Verified by:
Date:	File: 110409-2TA_DATASEP
Page number:	Approved:



# MAP

## Sample Separation

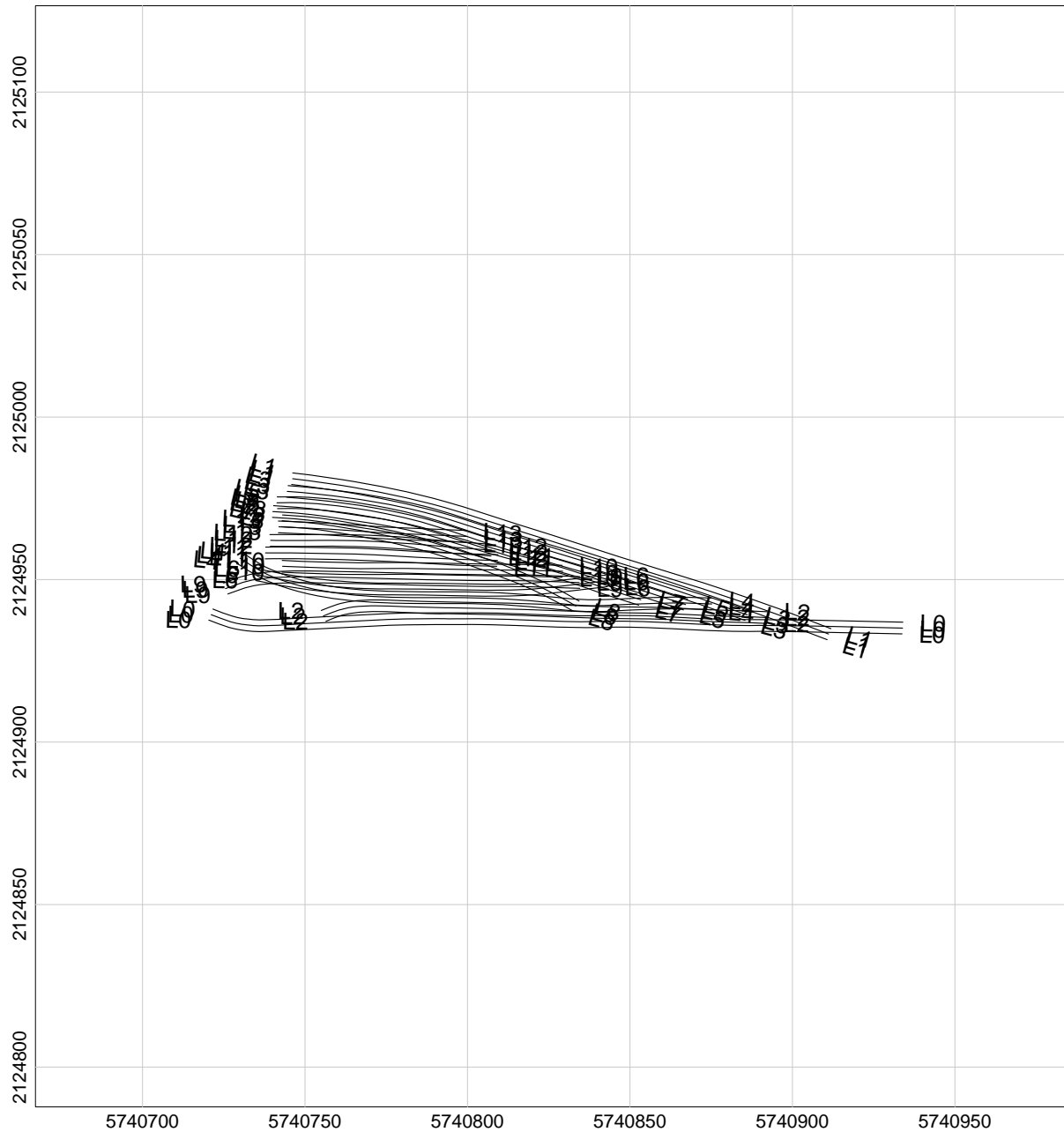

### LEGEND

- Line path
- Flag\_Separation

Data exceeding max. data spacing: 0.0%





Client:	
Project:	
Contractor:	
Created by:	Verified by:
Date:	File: 110409-3TA_DATASEP
Page number:	Approved:

# MAP

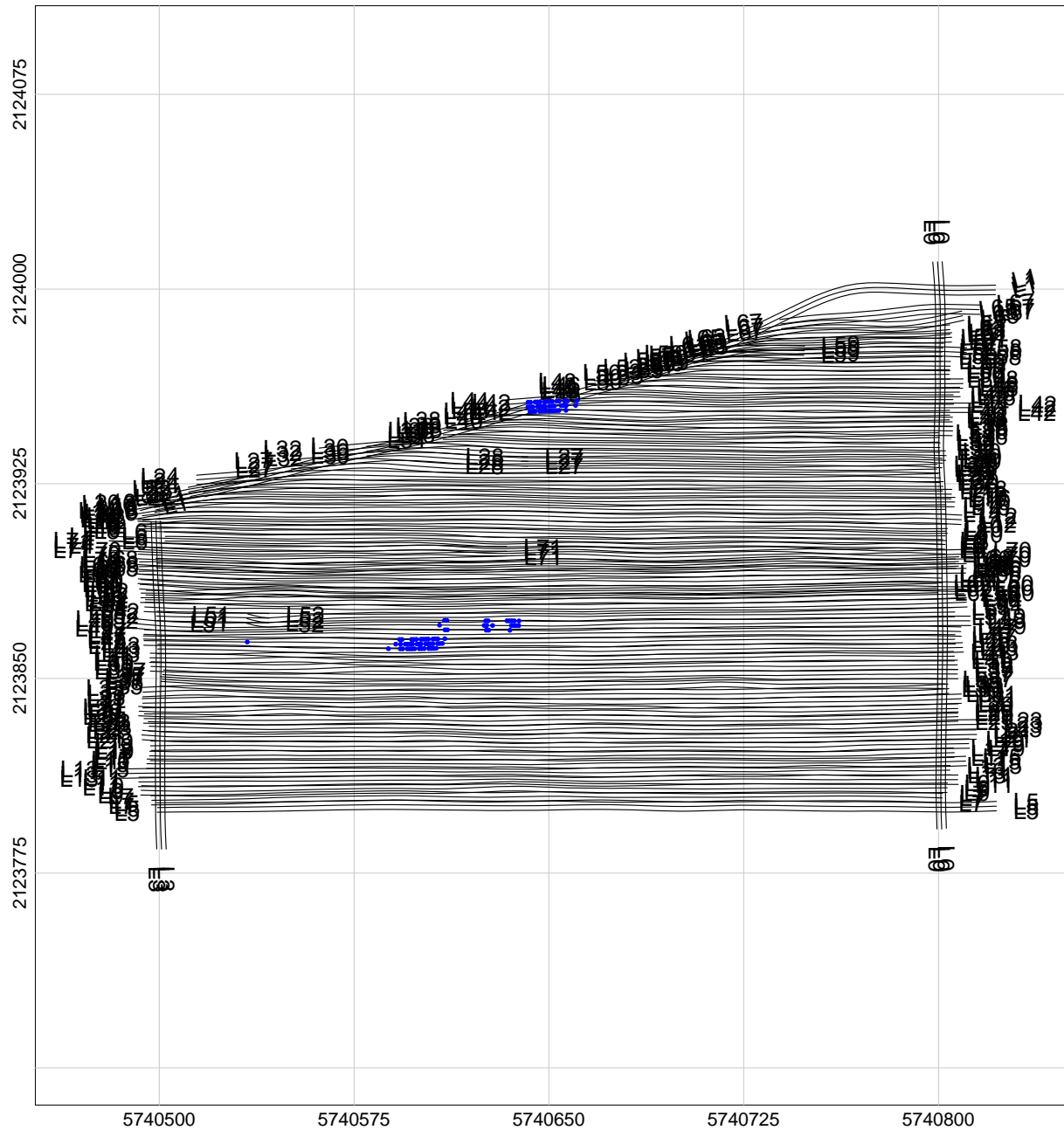
## Sample Separation



### LEGEND

-  Line path
-  Flag\_Separation

Data exceeding max. data spacing: 0.1%

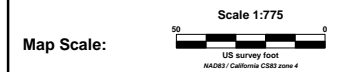

Client:	
Project:	
Contractor:	
Created by:	Verified by:
Date:	File: 110509-1TA_DATASEP
Page number:	Approved:

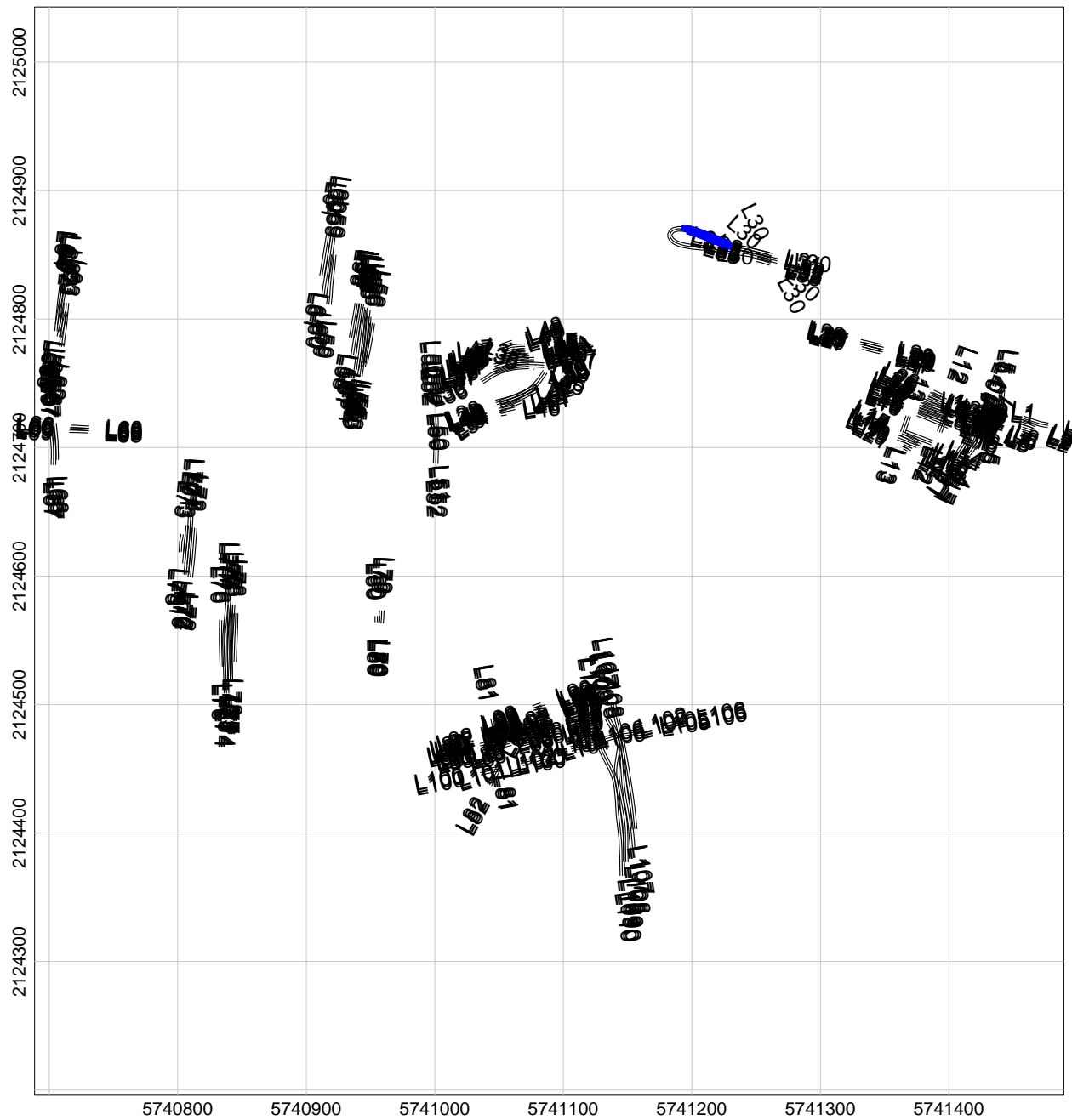

# MAP

## Sample Separation

### LEGEND

- Line path
  - Flag\_Separation
- Data exceeding max. data spacing: 0.6%

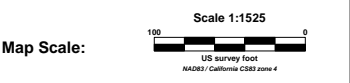



Client:	
Project:	
Contractor:	
Created by:	Verified by:
Date:	File: 110509-2TA_DATASEP
Page number:	Approved:

# MAP

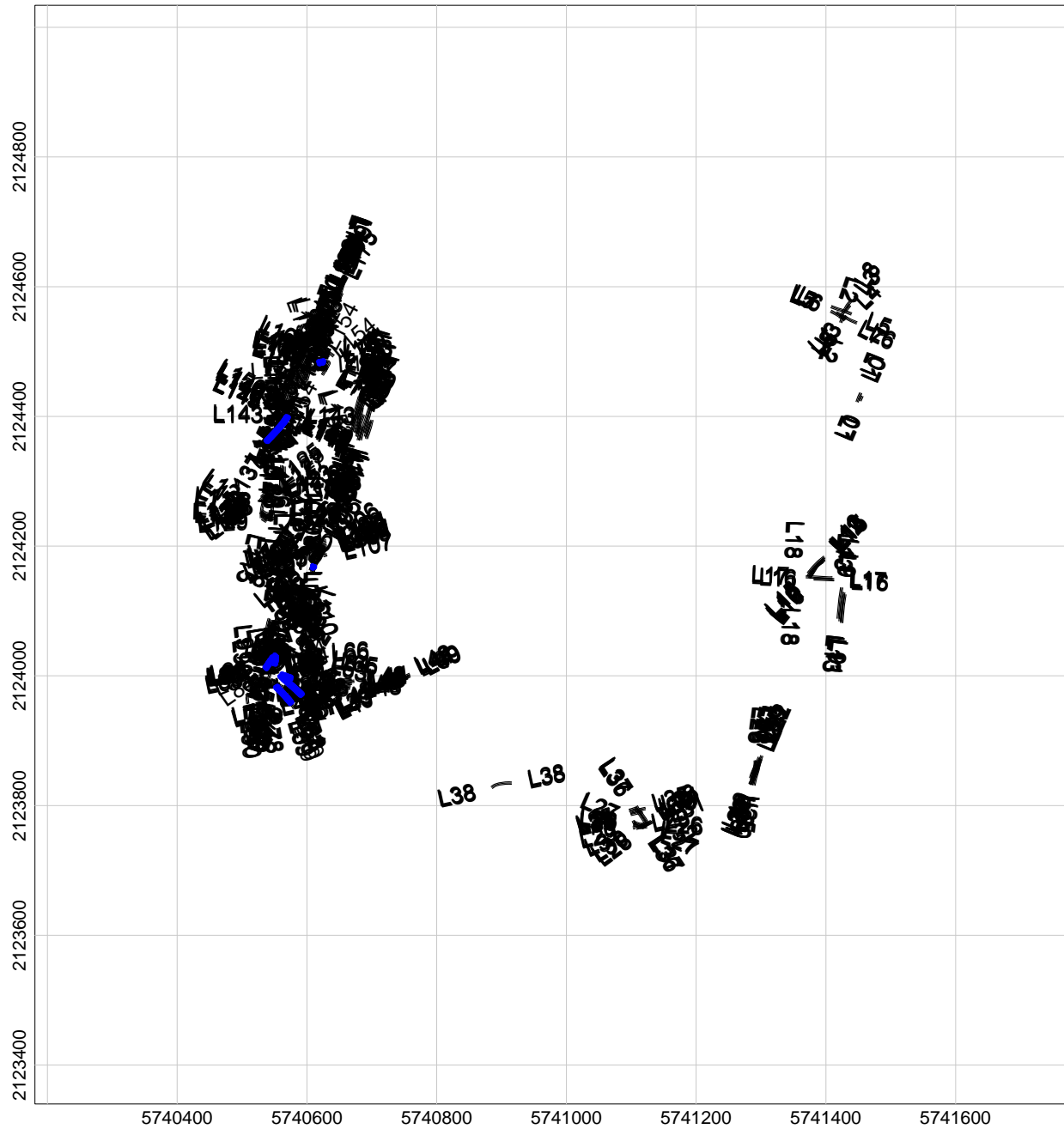
## Sample Separation



### LEGEND

-  Line path
-  Flag\_Separation

Data exceeding max. data spacing: 0.9%

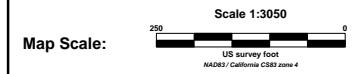

Client:	
Project:	
Contractor:	
Created by:	Verified by:
Date:	File: 110609-1TA_DATASEP
Page number:	Approved:

# MAP

## Sample Separation

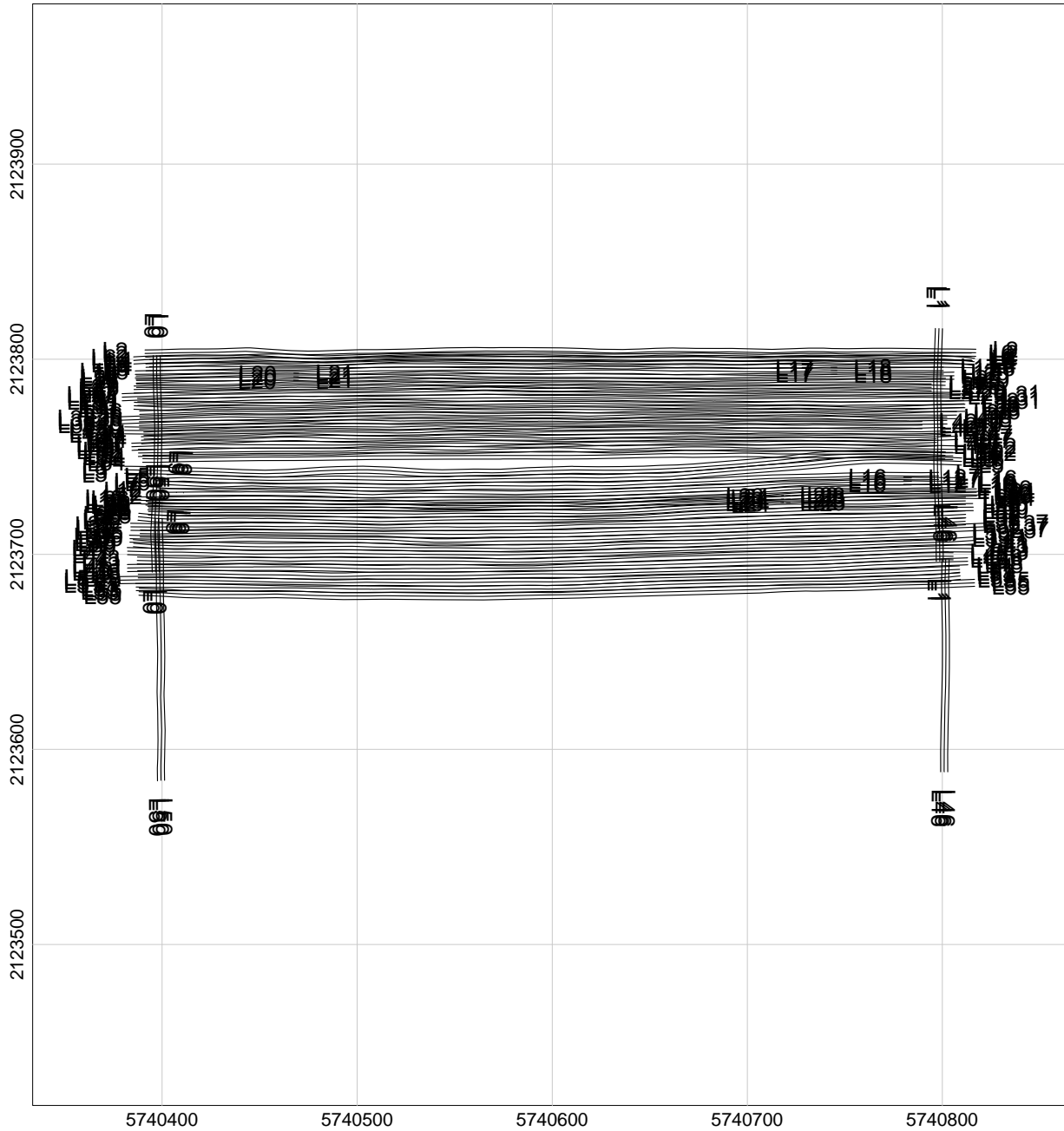

### LEGEND

- Line path
- ..... Flag\_Separation

Data exceeding max. data spacing: 0.0%



Client:	
Project:	
Contractor:	
Created by:	Verified by:
Date:	File: 110909-1TA_DATASEP
Page number:	Approved:

# MAP

## Sample Separation

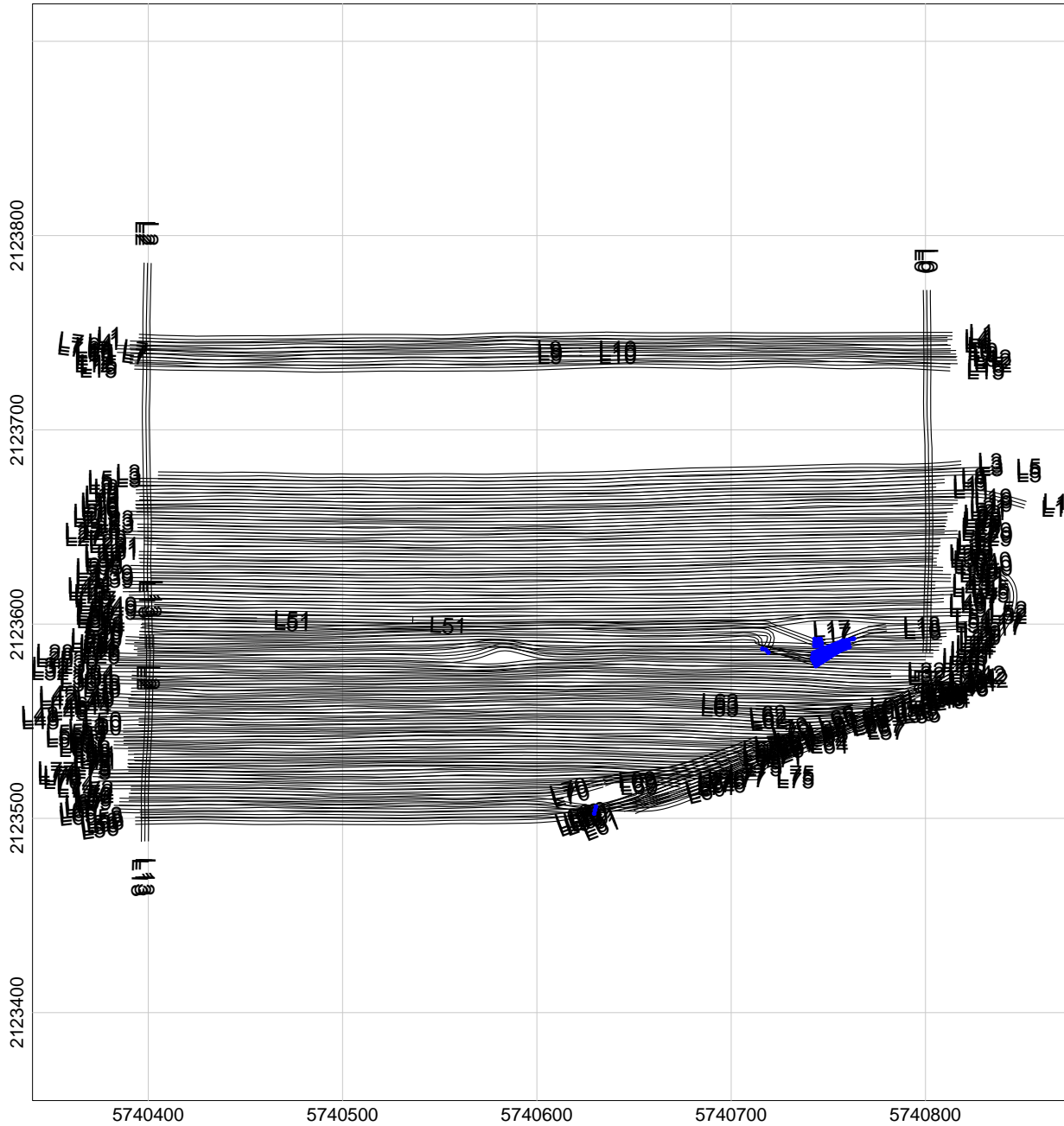

### LEGEND

- Line path
  - ..... Flag\_Separation
- Data exceeding max. data spacing: 0.1%



Client:	
Project:	
Contractor:	
Created by:	Verified by:
Date:	File: 110909-2TA_DATASEP
Page number:	Approved:

# MAP

## Sample Separation

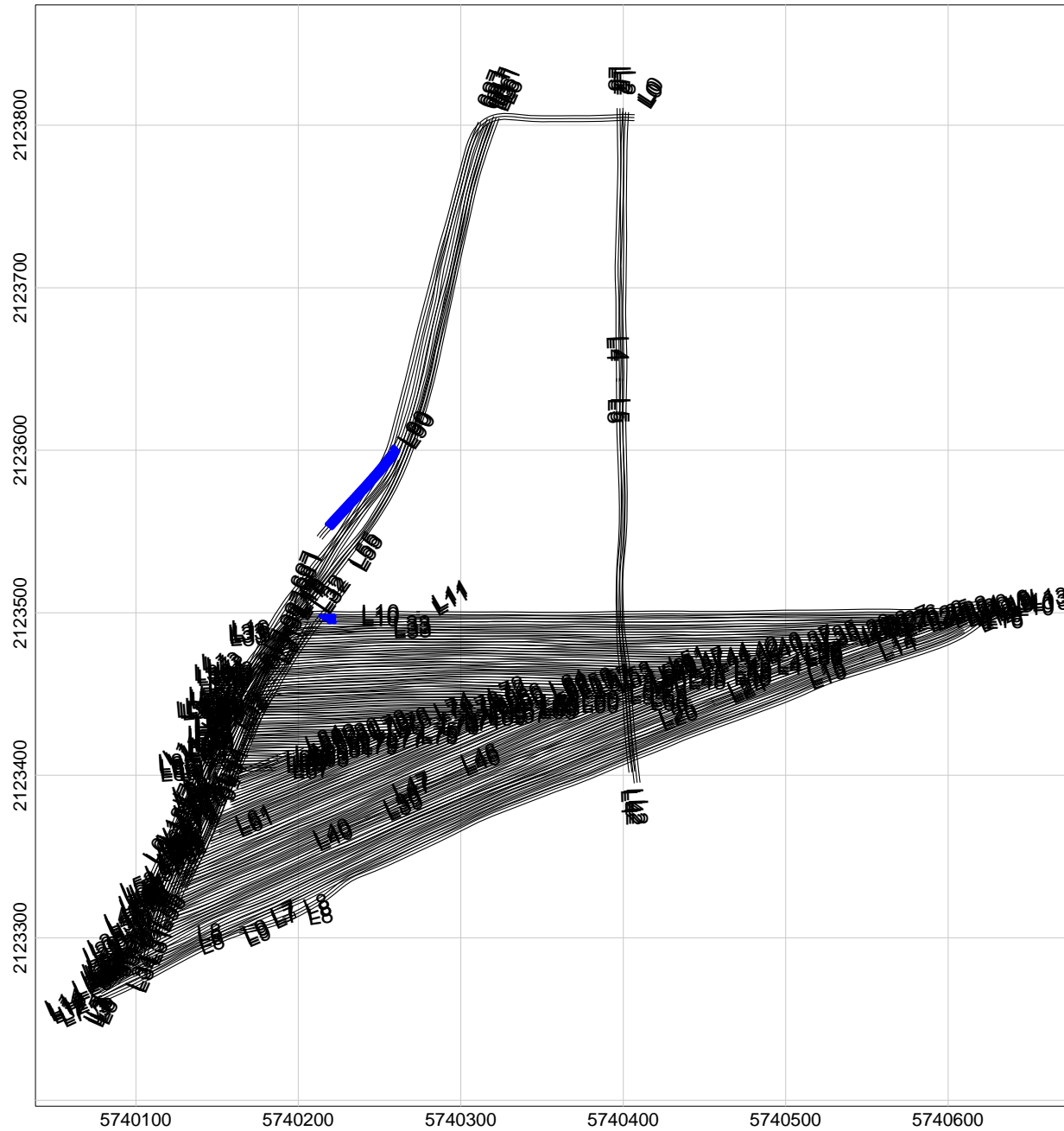

### LEGEND

- Line path
  - ..... Flag\_Separation
- Data exceeding max. data spacing: 0.1%





Client:	
Project:	
Contractor:	
Created by:	Verified by:
Date:	File: 111009-1TA_DATASEP
Page number:	Approved:

# MAP

## Sample Separation

### LEGEND

-  Line path
  -  Flag\_Separation
- Data exceeding max. data spacing: 0.2%

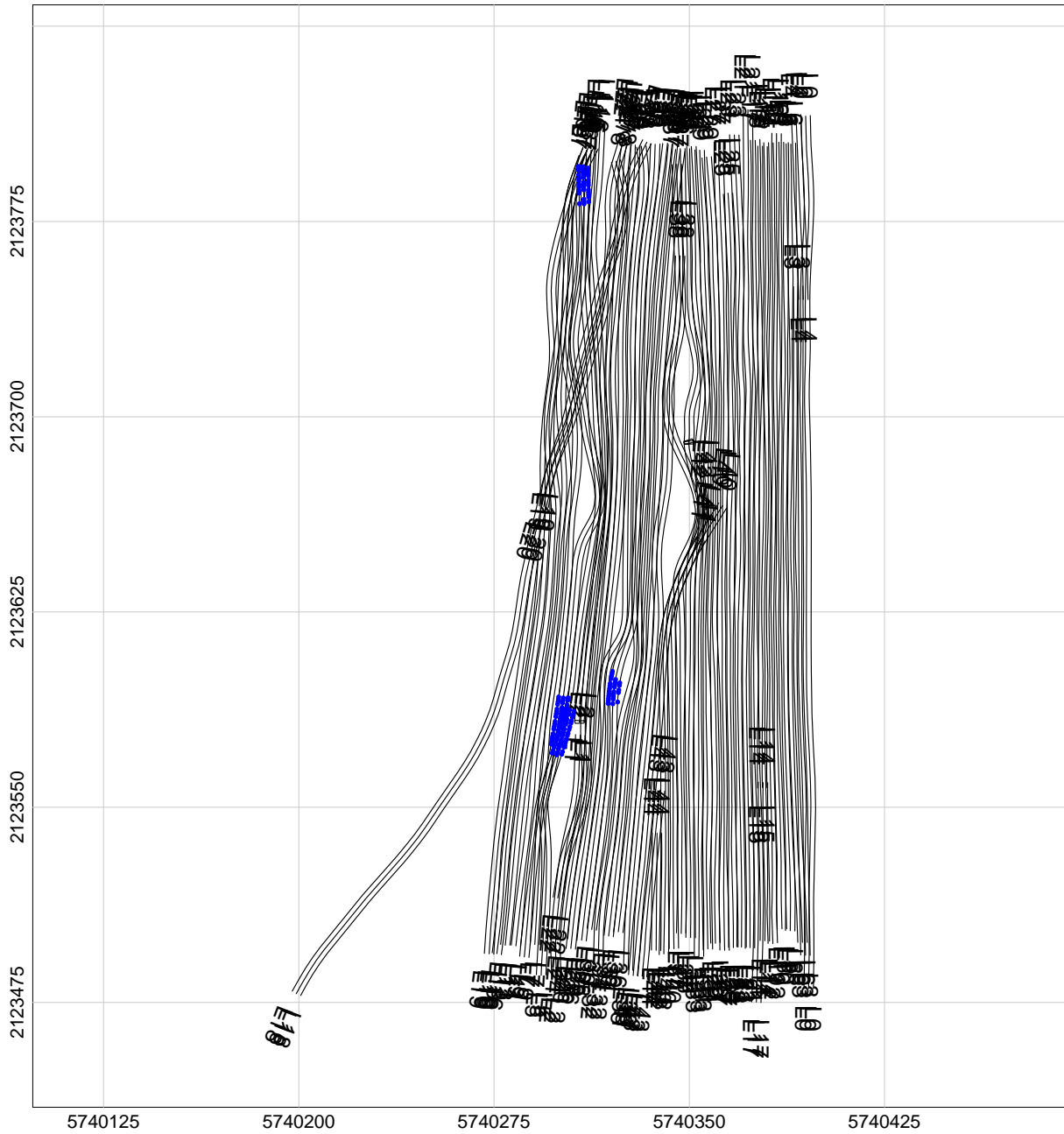
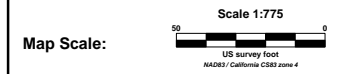

Client:	
Project:	
Contractor:	
Created by:	Verified by:
Date:	File: 111009-2TA_DATASEP
Page number:	Approved:



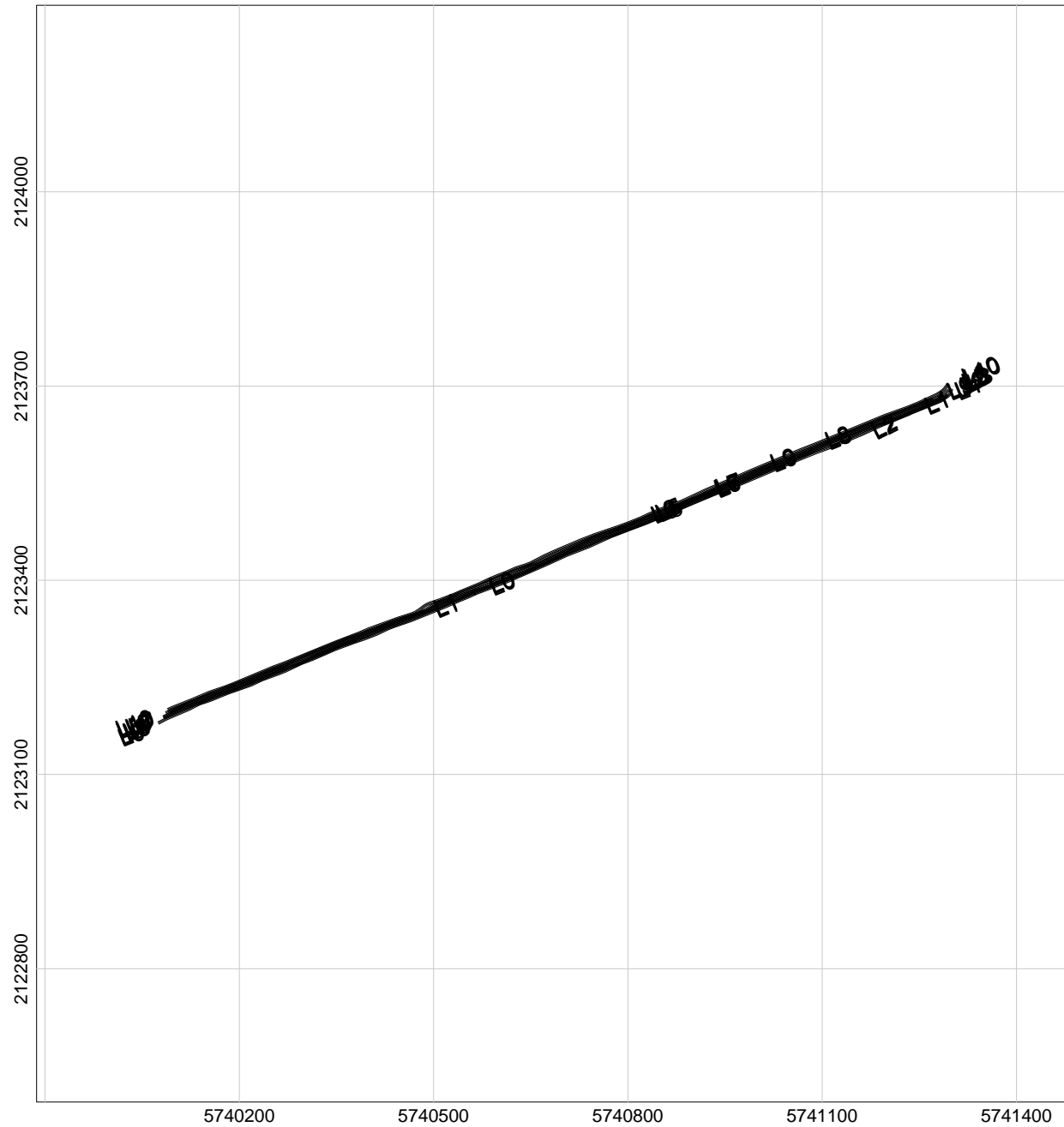

# MAP

## Sample Separation



### LEGEND

-  Line path
-  Flag\_Separation

Data exceeding max. data spacing: 0.0%

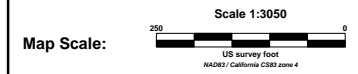

Client:	
Project:	
Contractor:	
Created by:	Verified by:
Date:	File: 111009-3TA_DATASEP
Page number:	Approved:

# MAP

## Sample Separation

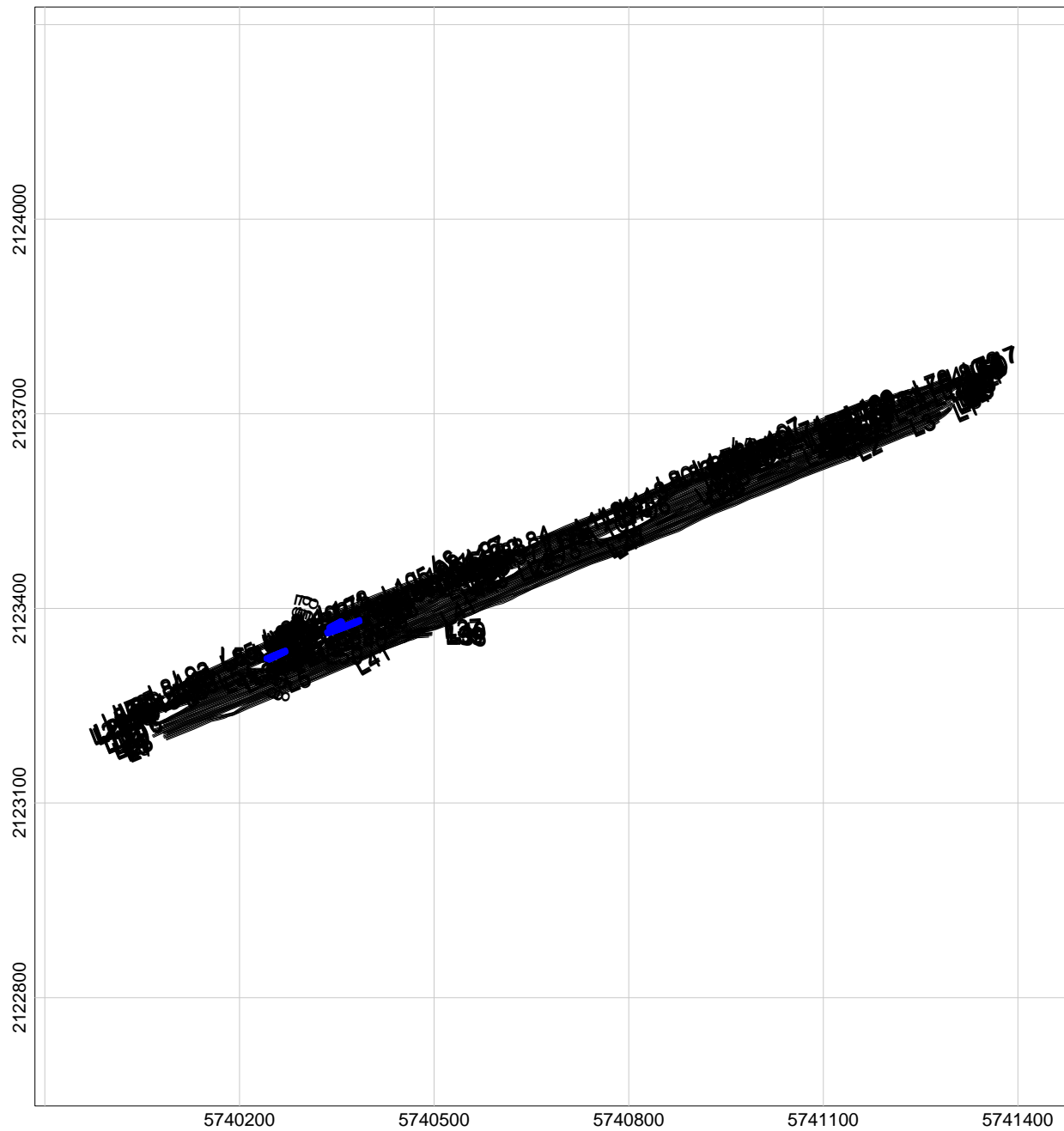

### LEGEND

- Line path
  - Flag\_Separation
- Data exceeding max. data spacing: 0.1%

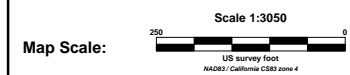

Client:	
Project:	
Contractor:	
Created by:	Verified by:
Date:	File: 111109-1TA_DATASEP
Page number:	Approved:

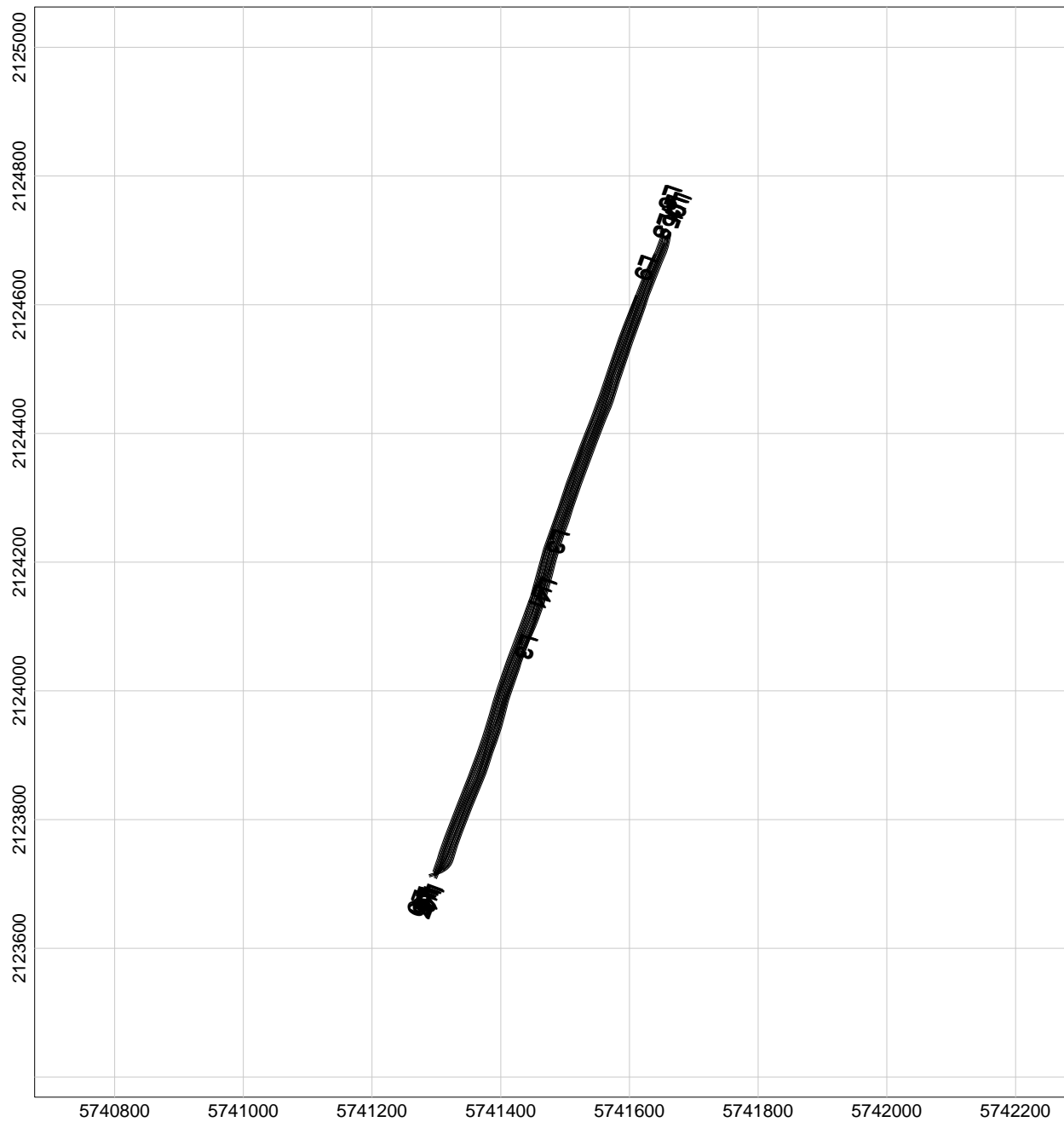

# MAP

## Sample Separation

### LEGEND

- Line path
- ..... Flag\_Separation

Data exceeding max. data spacing: 0.0%

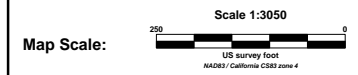

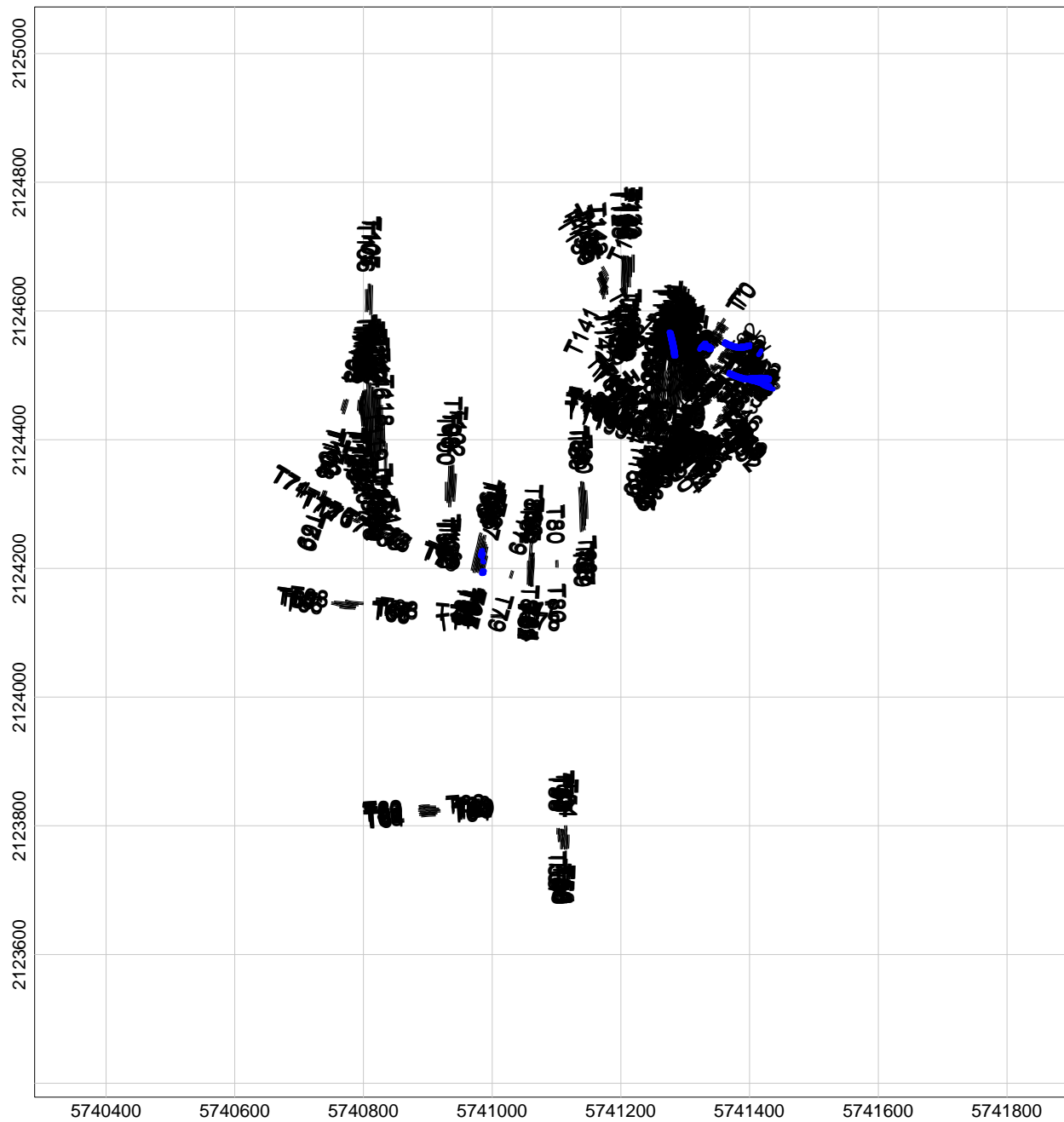

Client:	
Project:	
Contractor:	
Created by:	Verified by:
Date:	File: 111109-2TA_DATASEP
Page number:	Approved:



# MAP

## Sample Separation

### LEGEND

-  Line path
-  Flag\_Separation

Data exceeding max. data spacing: 1.1%

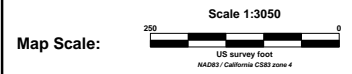

Client:	
Project:	
Contractor:	
Created by:	Verified by:
Date:	File: 111209-1TA_DATASEP
Page number:	Approved:

# MAP

## Sample Separation

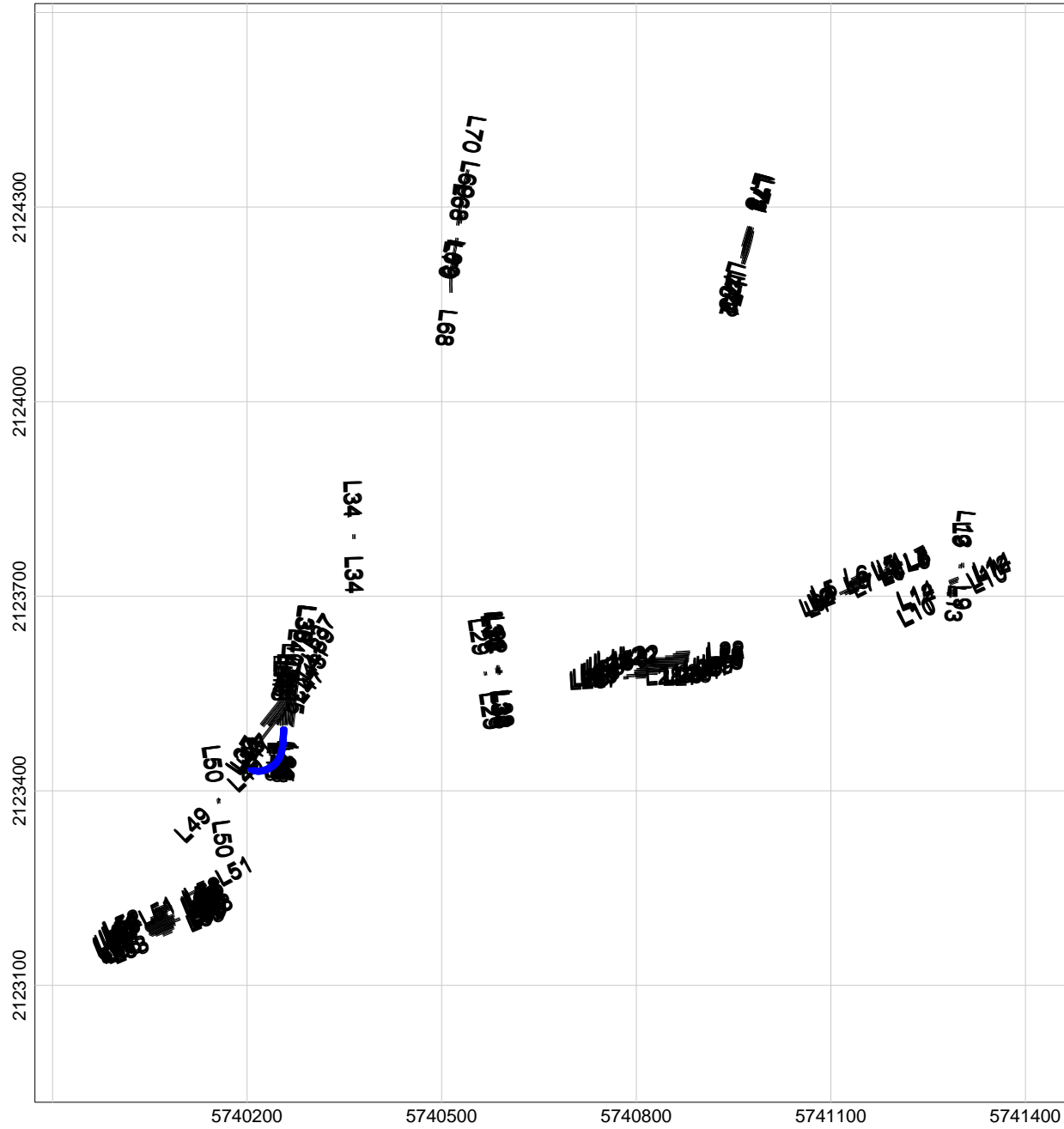

### LEGEND

- Line path
  - ..... Flag\_Separation
- Data exceeding max. data spacing: 1.8%

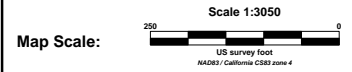



Client:	
Project:	
Contractor:	
Created by:	Verified by:
Date:	File: 111309-1TA_DATASEP
Page number:	Approved:

# MAP

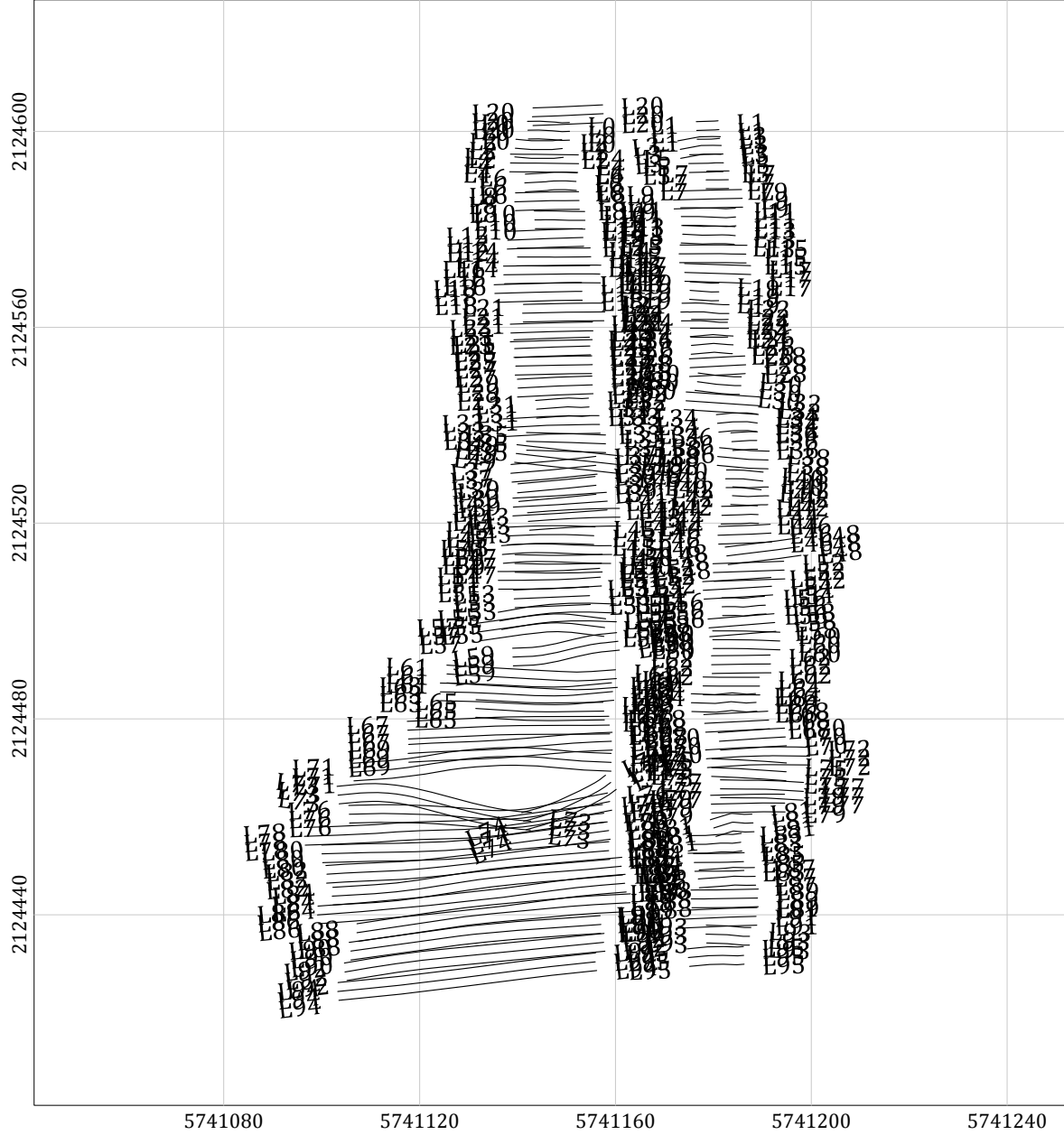
## Sample Separation



### LEGEND

-  Line path
  -  Flag\_Separation
- Data exceeding max. data spacing: 0.0%



Client:	
Project:	
Contractor:	
Created by:	Verified by:
Date:	File: 113009-1TA_DATASEP
Page number:	Approved:

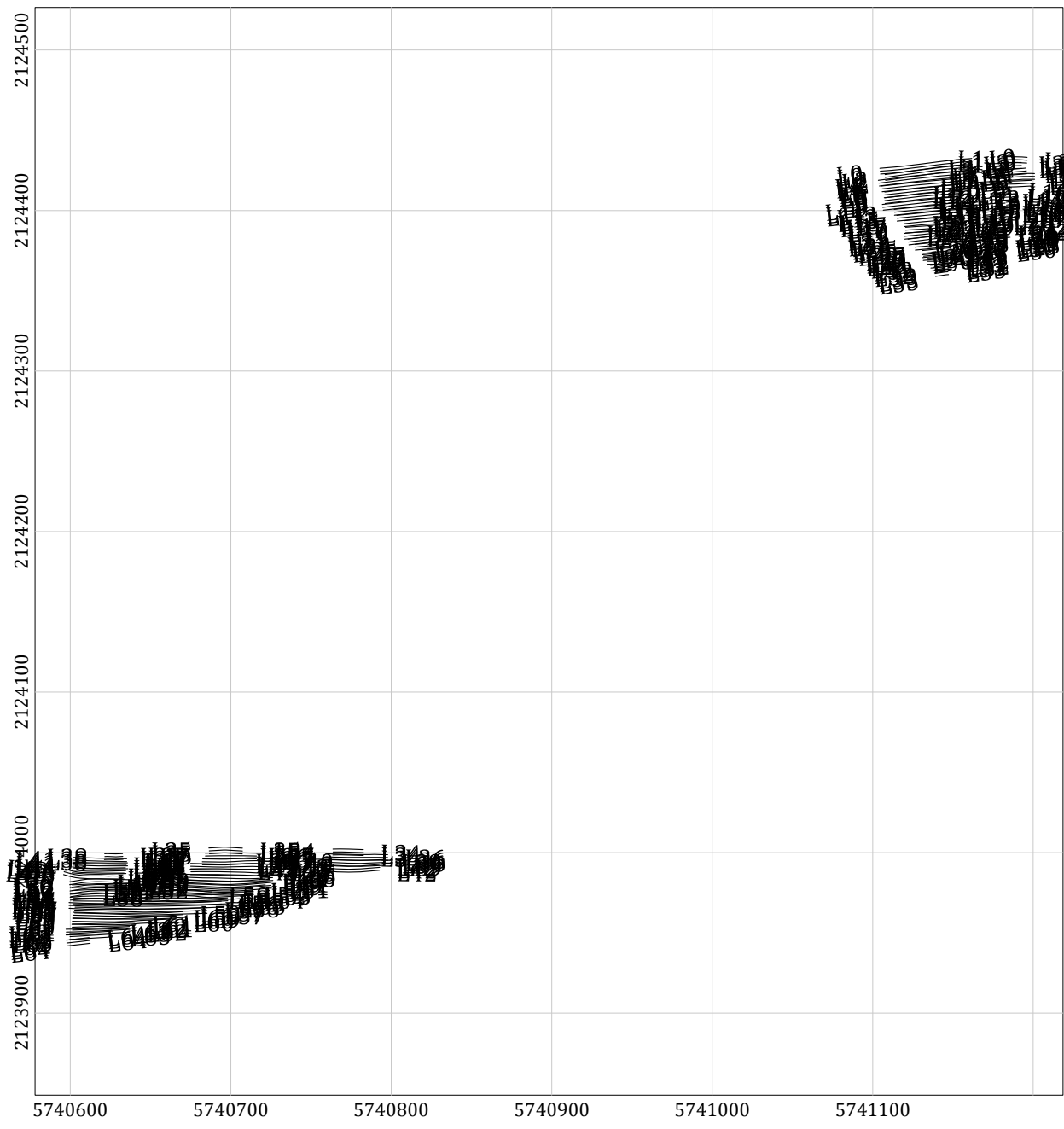

# MAP

## Sample Separation

### LEGEND

- Line path
  - Flag\_Separation
- Data exceeding max. data spacing: 0.0%



Client:	
Project:	
Contractor:	
Created by:	Verified by:
Date:	File: 120109-1TA_DATASEP
Page number:	Approved:

# MAP

## Sample Separation

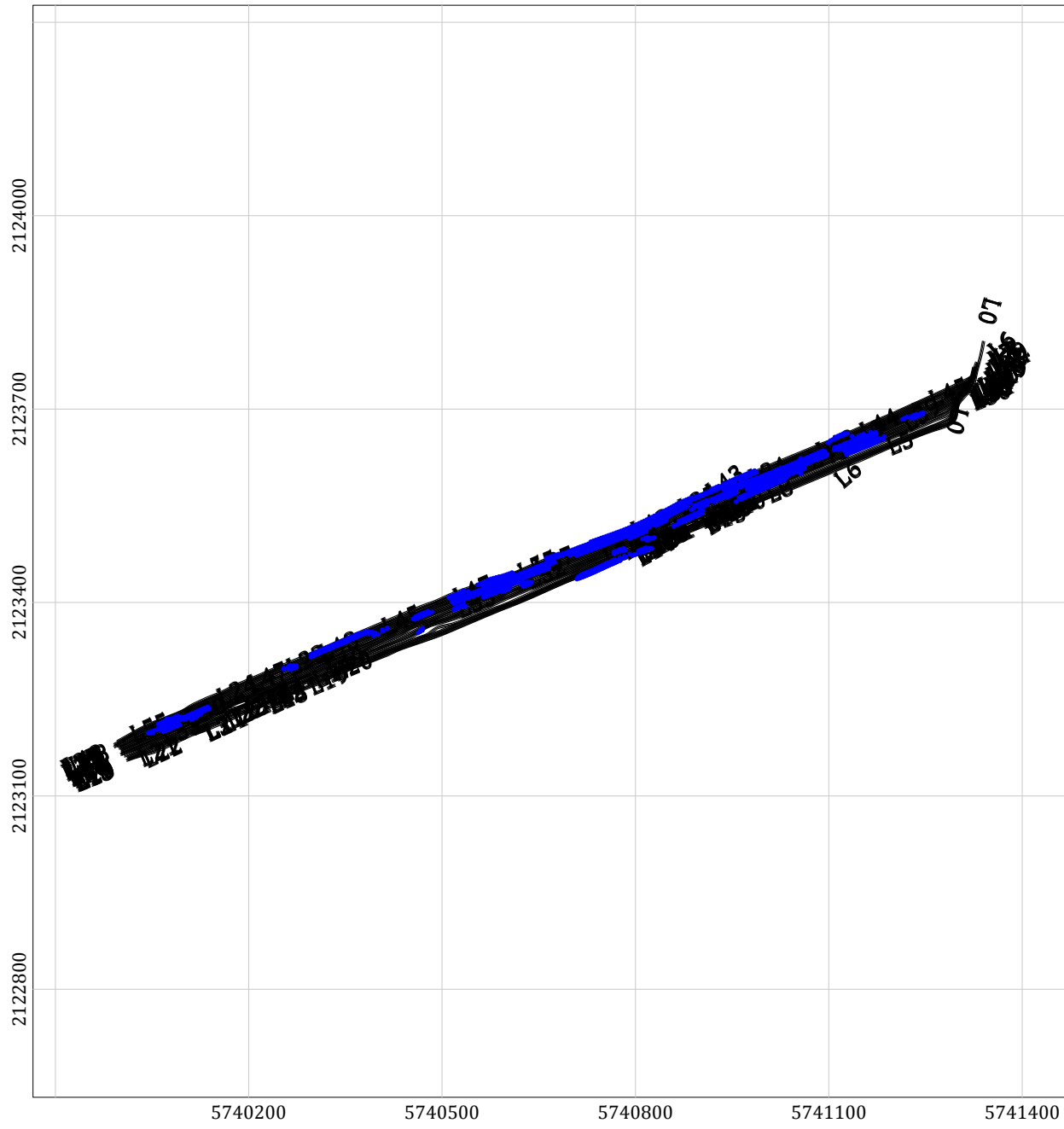

### LEGEND

- Line path
  - ..... Flag\_Separation
- Data exceeding max. data spacing: 0.9%

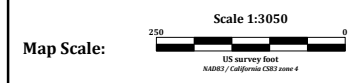

Client:	
Project:	
Contractor:	
Created by:	Verified by:
Date:	File: 121009-1TA_DATASEP
Page number:	Approved:



# MAP

## Sample Separation



### LEGEND

- Line path
  - Flag\_Separation
- Data exceeding max. data spacing: 0.2%

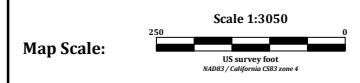



Client:	
Project:	
Contractor:	
Created by:	Verified by:
Date:	File: 122909-1TA_DATASEP
Page number:	Approved:

# MAP

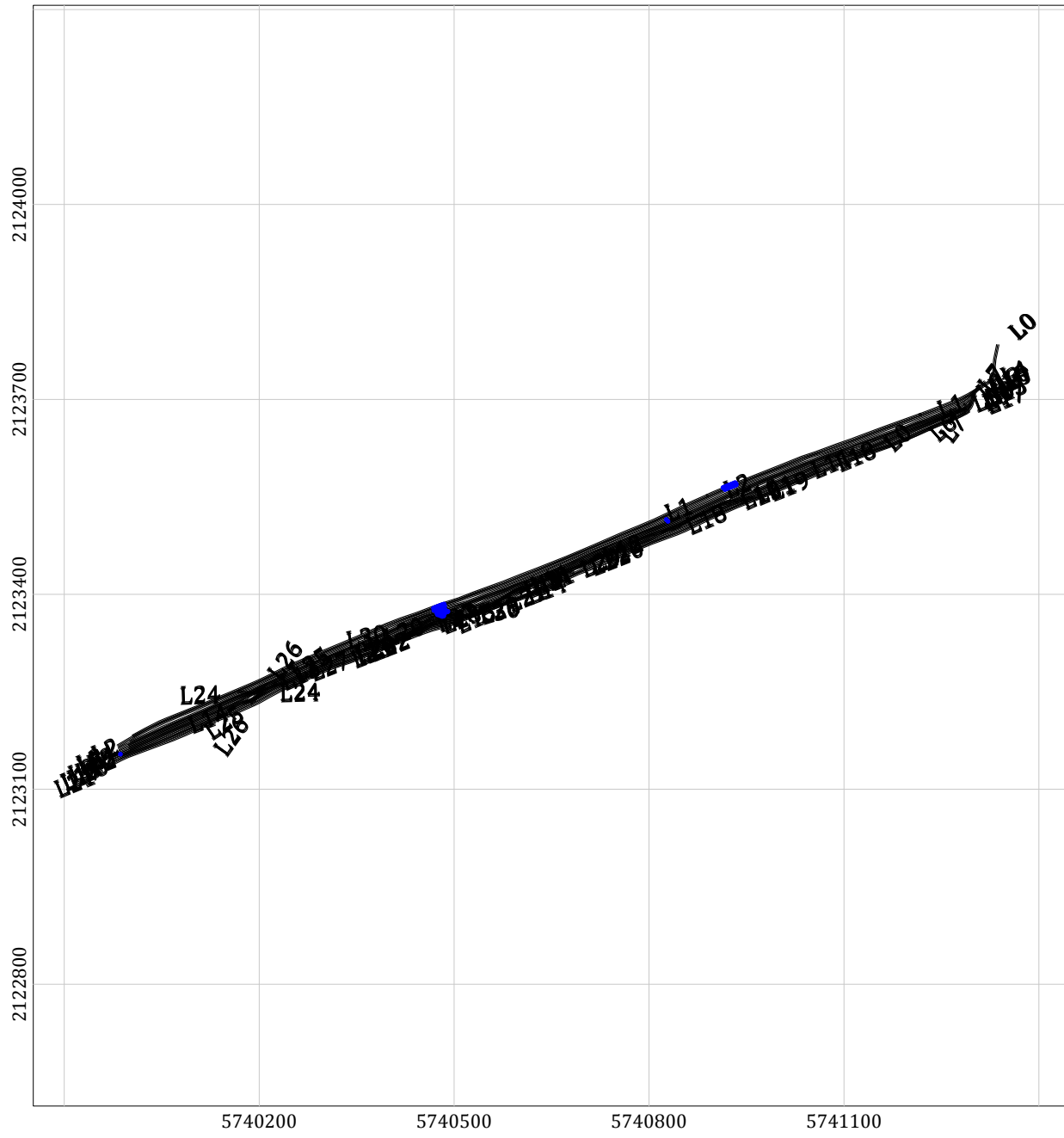
## Sample Separation



### LEGEND

-  Line path
  -  Flag Separation
- Data exceeding max. data spacing: 0.1%

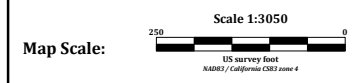

Client:	
Project:	
Contractor:	
Created by:	Verified by:
Date:	File: 122909-2TA_DATASEP
Page number:	Approved:

# MAP

## Sample Separation

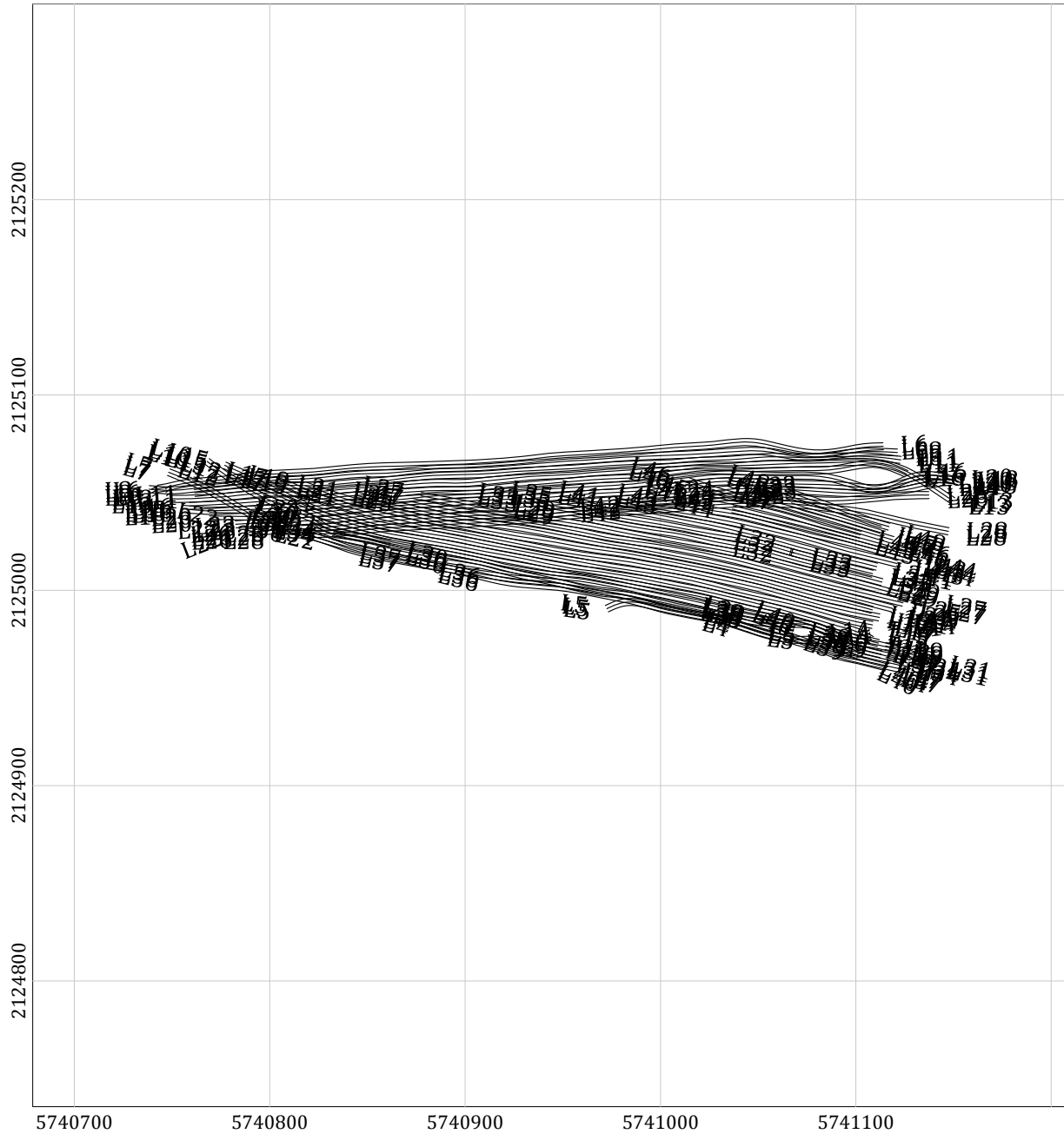

### LEGEND

- Line path
  - ..... Flag Separation
- Data exceeding max. data spacing: 0.0%





Client:	
Project: Fort Ord- Parker Flats	
Contractor:	
Created by:	Verified by:
Date:	File: 011110-1TA_DATASEP
Page number:	Approved:

# MAP

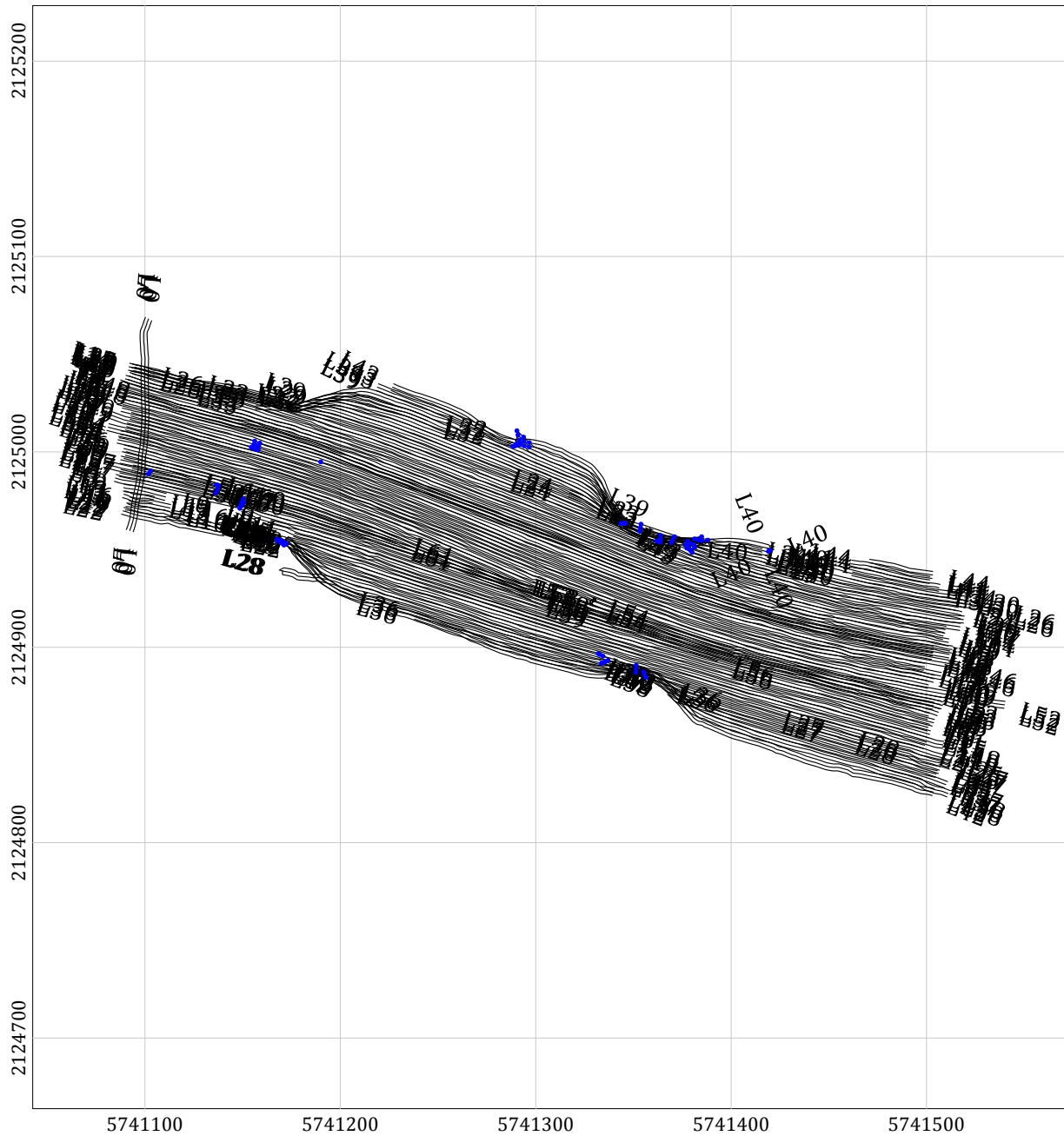
## Sample Separation



### LEGEND

-  Line path
  -  Flag\_Separation
- Data exceeding max. data spacing: 0.1%



Client:	
Project:	
Contractor:	
Created by:	Verified by:
Date:	File: 011210-1TA_DATASEP
Page number:	Approved:

# MAP

## Sample Separation

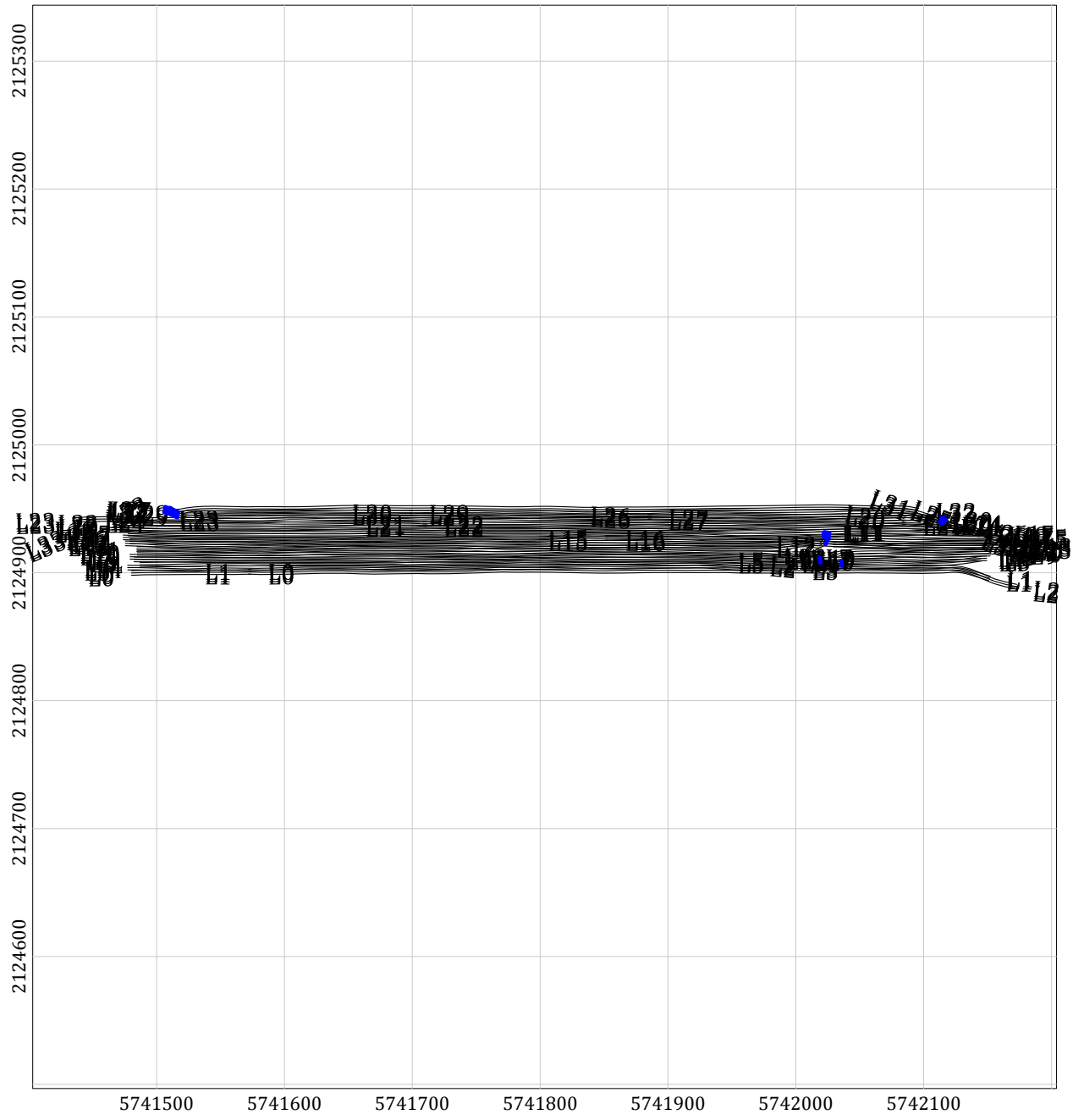

### LEGEND

- Line path
  - Flag\_Separation
- Data exceeding max. data spacing: 0.1%

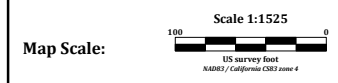



Client:	
Project:	
Contractor:	
Created by:	Verified by:
Date:	File: 011210-2TA_DATASEP
Page number:	Approved:

# MAP

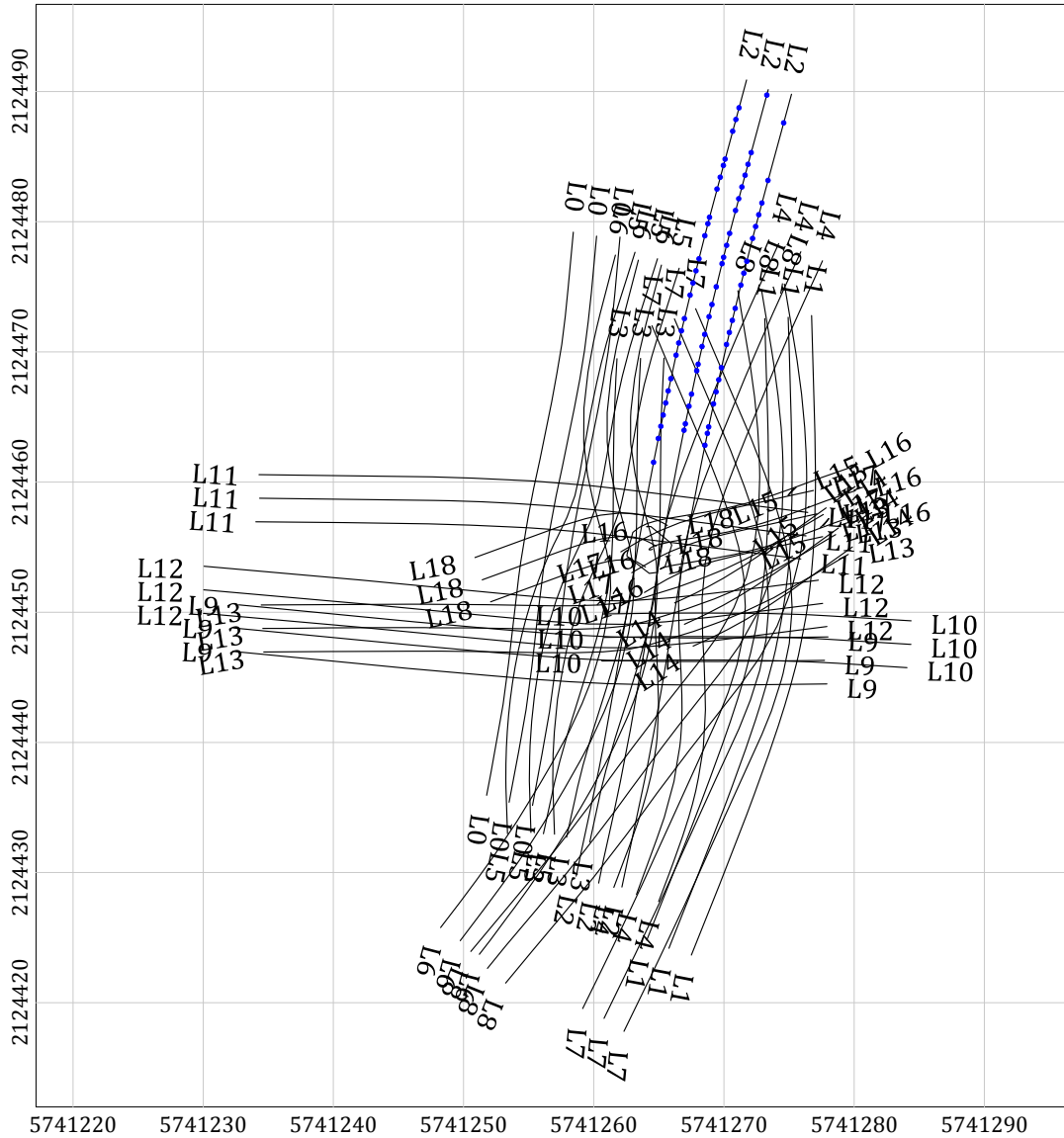
## Sample Separation



### LEGEND

-  Line path
  -  Flag\_Separation
- Data exceeding max. data spacing: 0.8%



Client:	
Project:	
Contractor:	
Created by:	Verified by:
Date:	File: 011310-1TA_DATASEP
Page number:	Approved:

# MAP

## Sample Separation

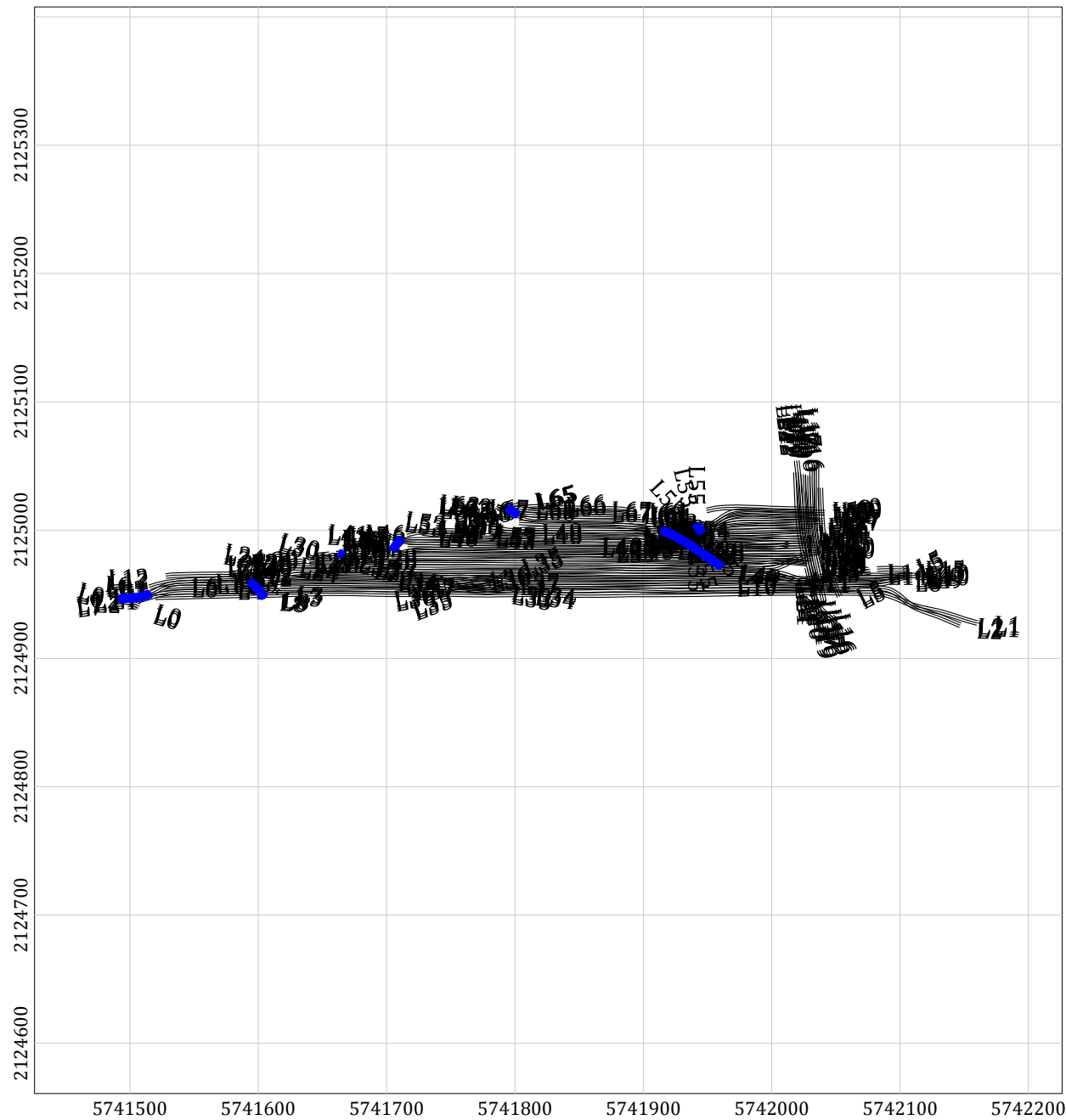

### LEGEND

- Line path
  - Flag\_Separation
- Data exceeding max. data spacing: 0.4%

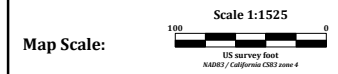

Client:	
Project:	
Contractor:	
Created by:	Verified by:
Date:	File: 011410-1TA_DATASEP
Page number:	Approved:

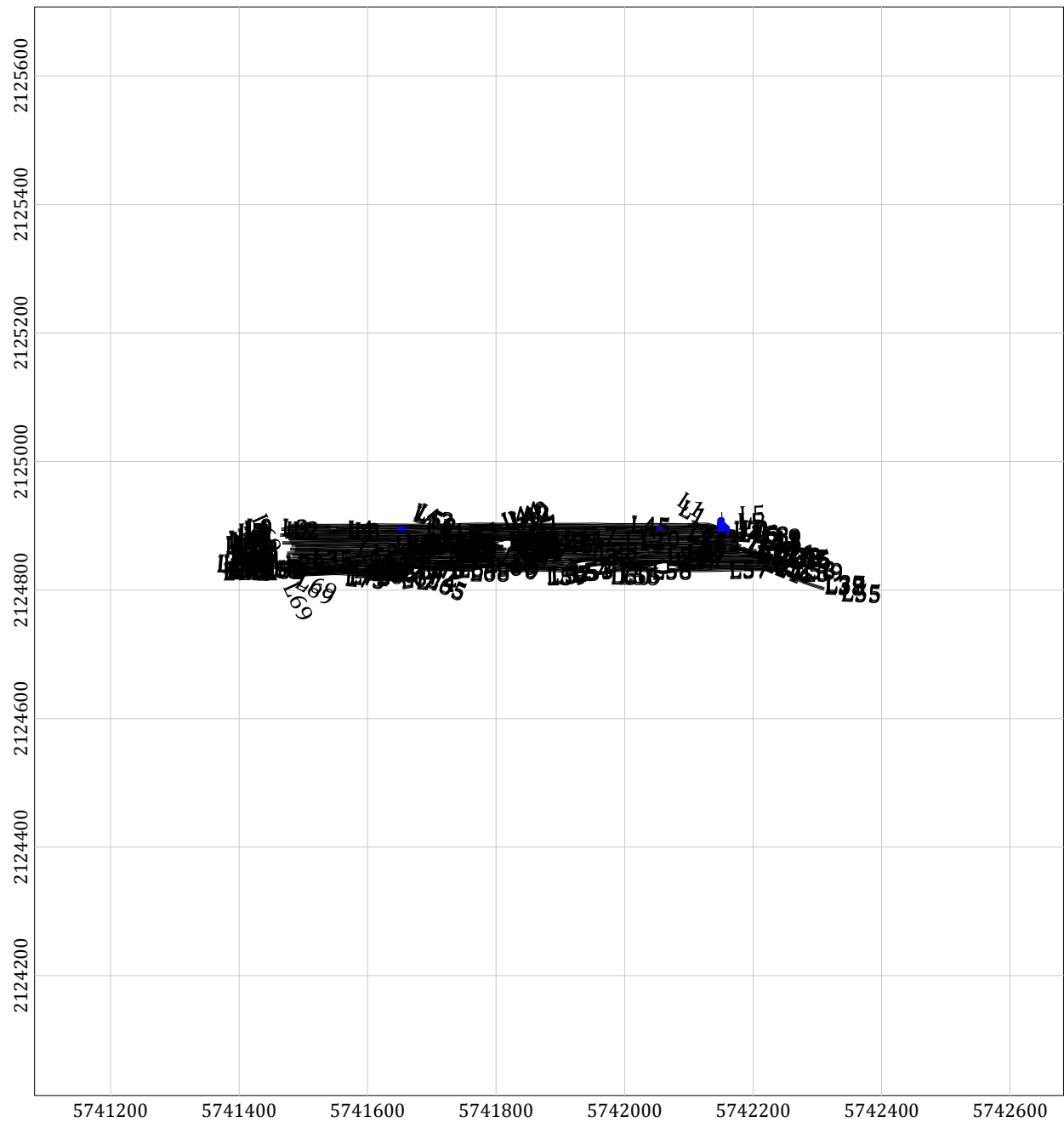

# MAP

## Sample Separation

### LEGEND

- Line path
  - Flag\_Separation
- Data exceeding max. data spacing: 0.1%

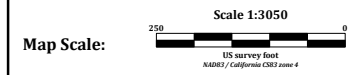

Client:	
Project:	
Contractor:	
Created by:	Verified by:
Date:	File: 011410-2TA_DATASEP
Page number:	Approved:



# MAP

## Sample Separation

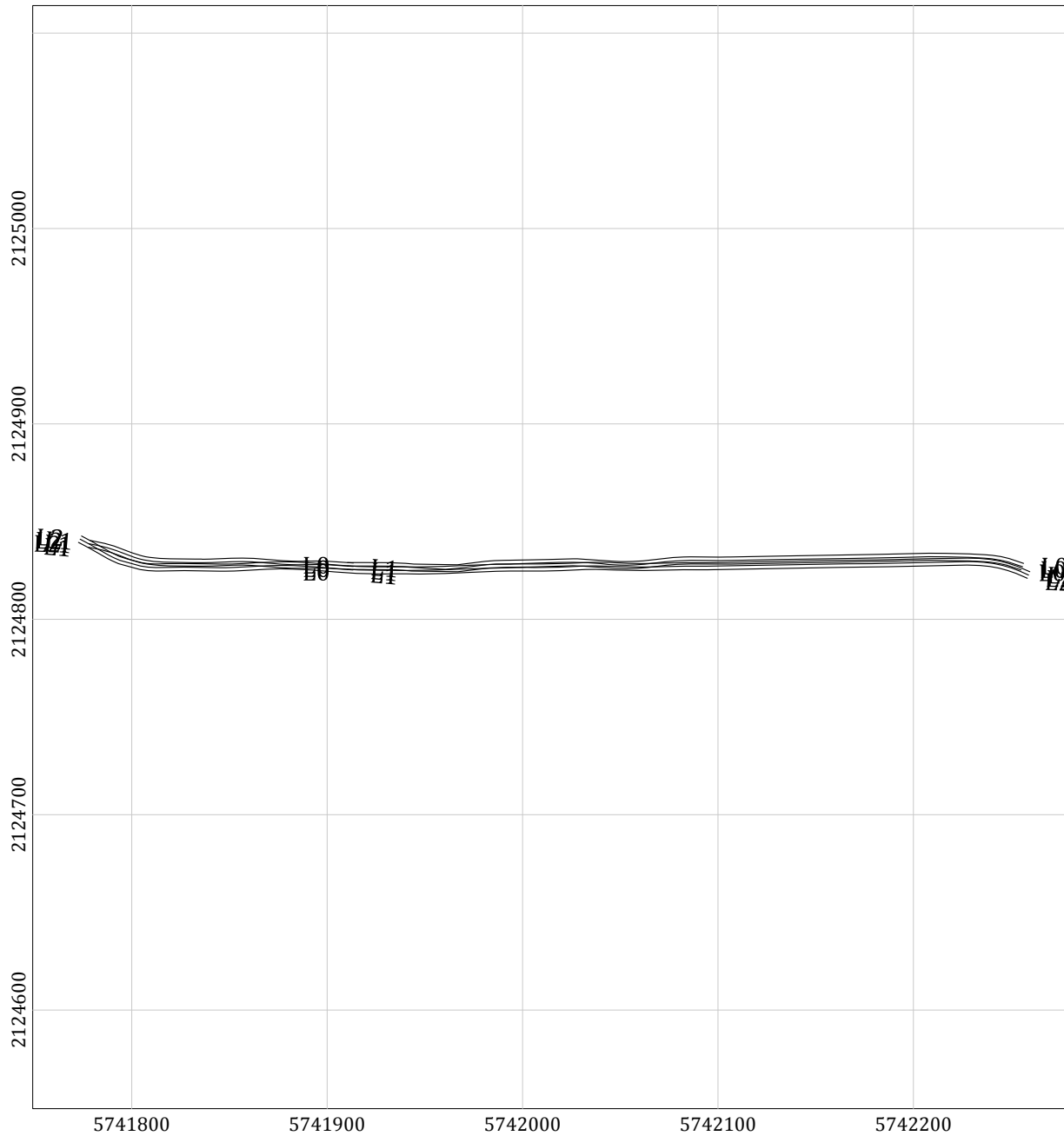

### LEGEND

- Line path
  - Flag\_Separation
- Data exceeding max. data spacing: 0.0%



Client:	
Project:	
Contractor:	
Created by:	Verified by:
Date:	File: 011810-1TA_DATASEP
Page number:	Approved:

# MAP

## Sample Separation

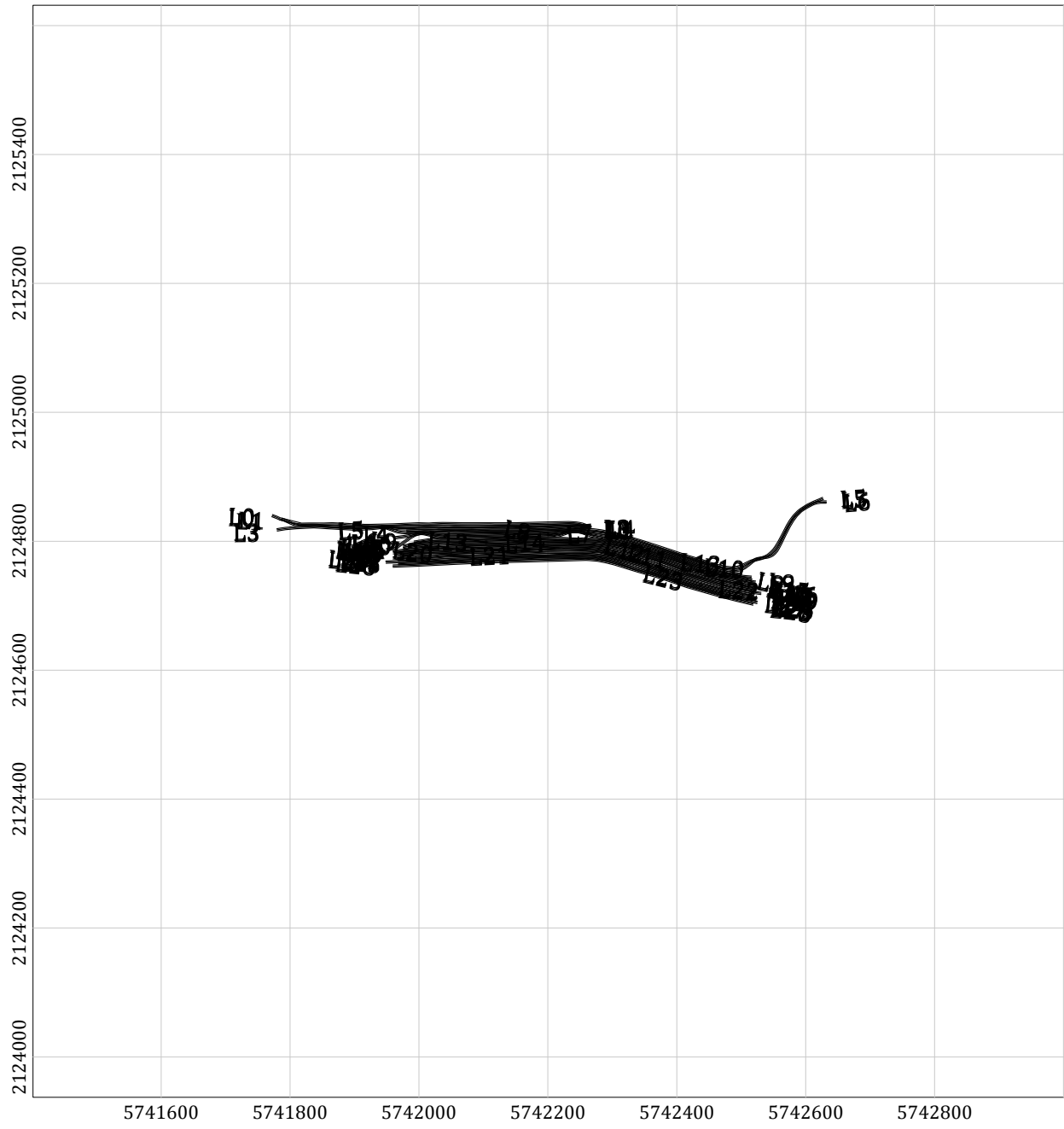

### LEGEND

-  Line path
  -  Flag\_Separation
- Data exceeding max. data spacing: 0.0%

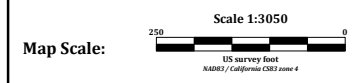

Client:	
Project:	
Contractor:	
Created by:	Verified by:
Date:	File: 011810-2TA_DATASEP
Page number:	Approved:

# MAP

## Sample Separation

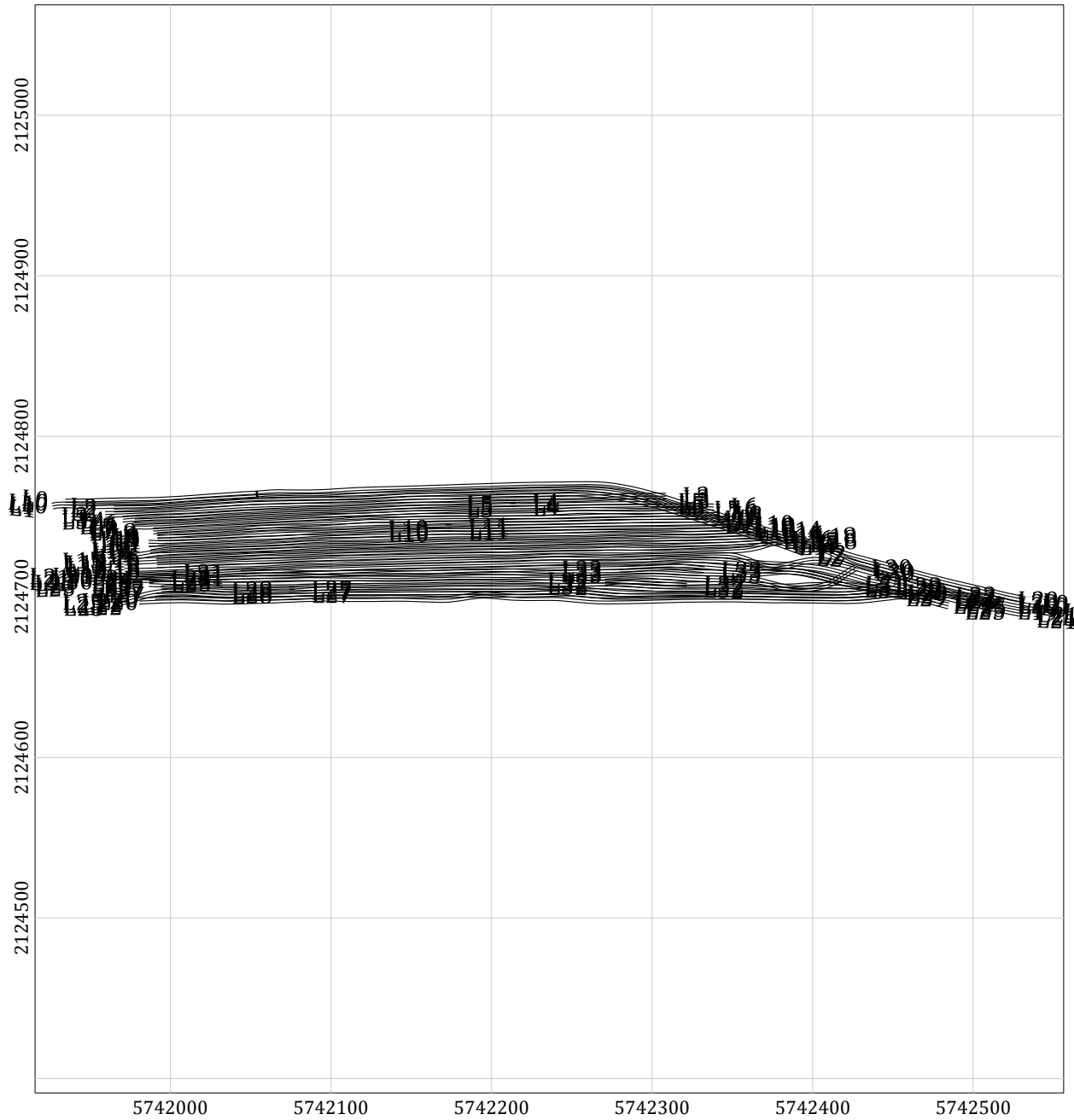

### LEGEND

- Line path
- Flag\_Separation

Data exceeding max. data spacing: 0.0%



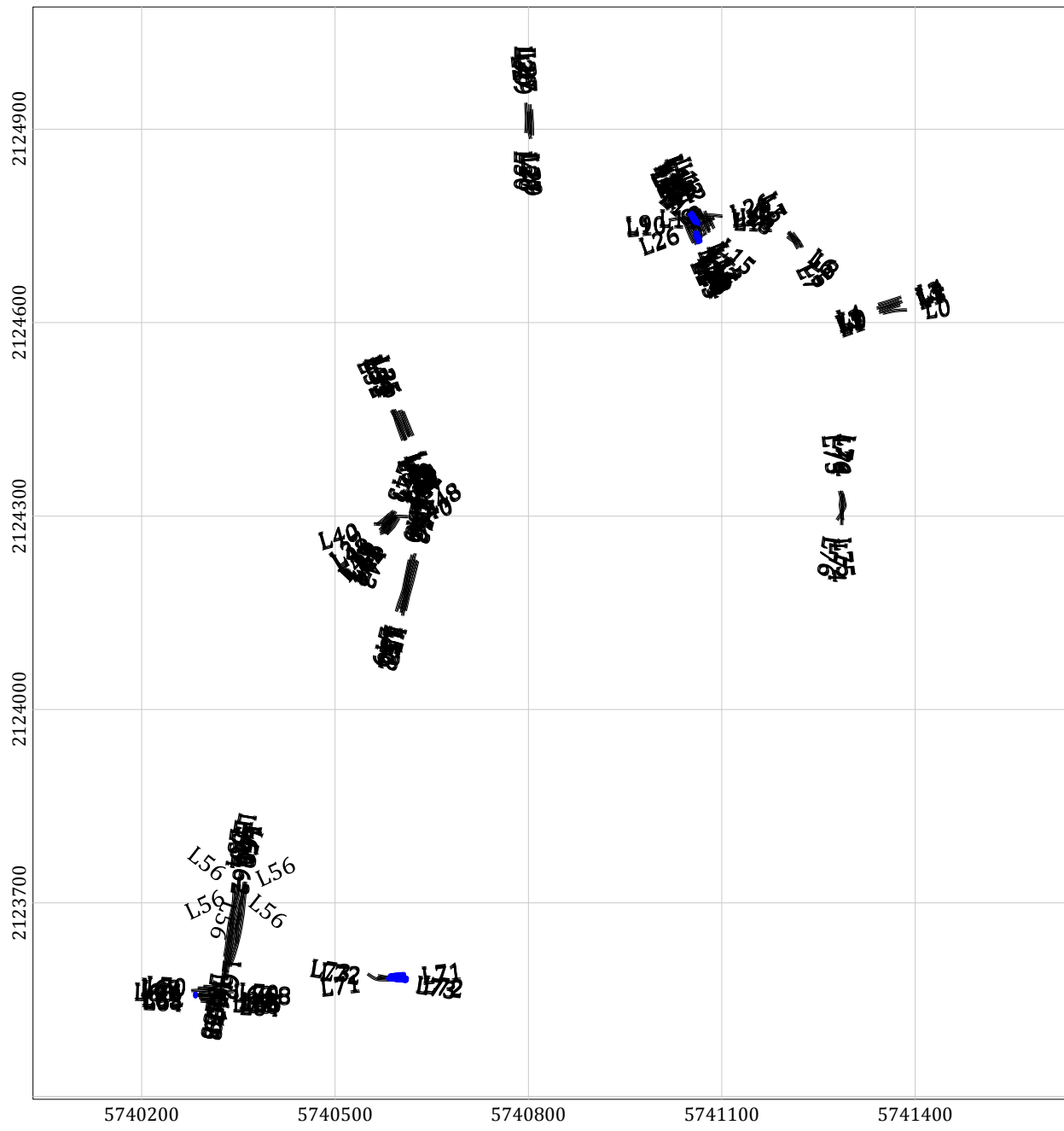

Client:	
Project:	
Contractor:	
Created by:	Verified by:
Date:	File: 012010-1TA_DATASEP
Page number:	Approved:



# MAP

## Sample Separation

### LEGEND

-  Line path
  -  Flag Separation
- Data exceeding max. data spacing: 0.8%

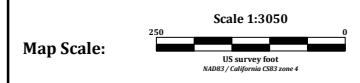



Client:	
Project:	
Contractor:	
Created by:	Verified by:
Date:	File: 012210-1TA_DATASEP
Page number:	Approved:

# MAP

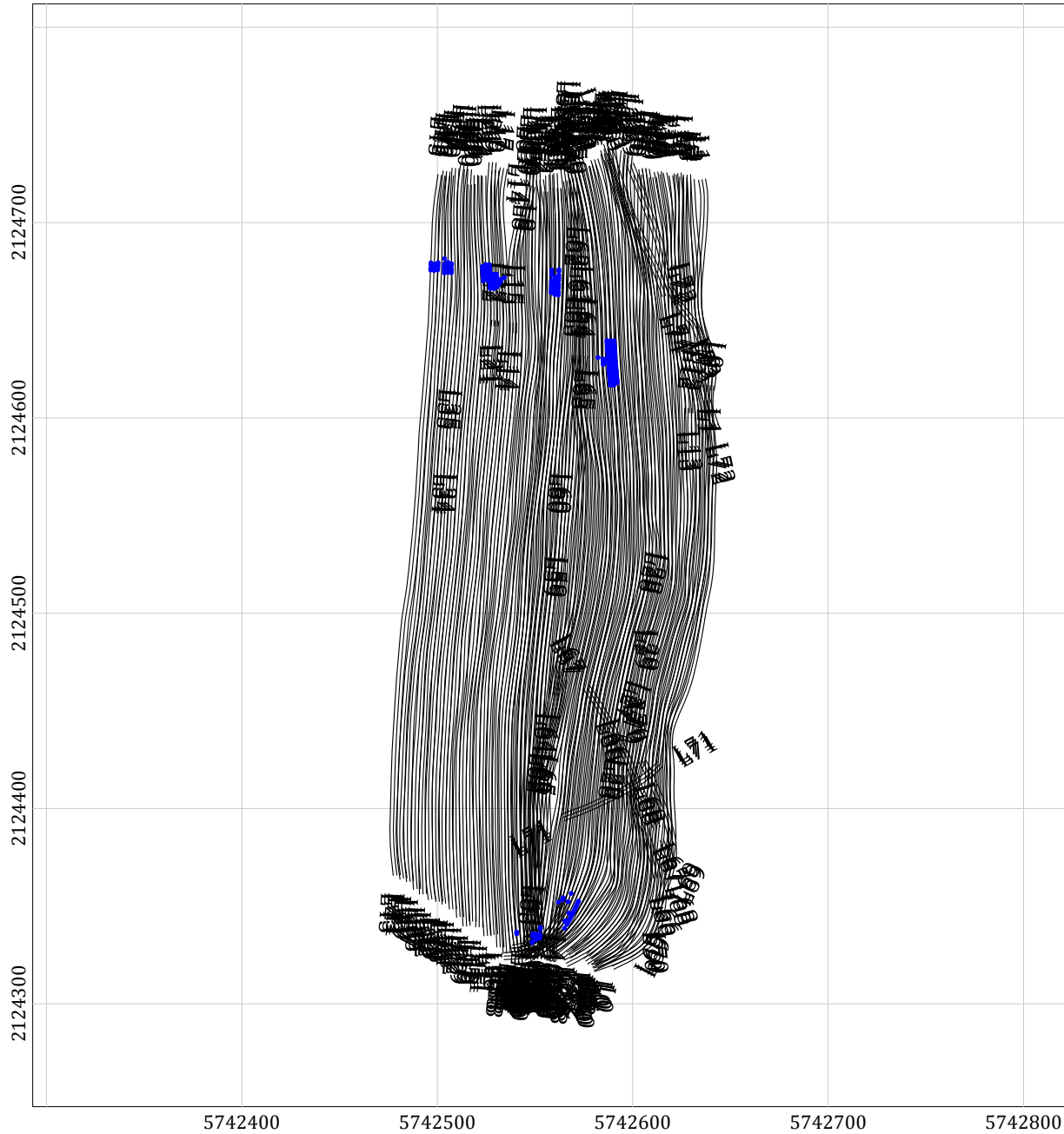
## Sample Separation



### LEGEND

-  Line path
  -  Flag Separation
- Data exceeding max. data spacing: 0.1%



Client:	
Project:	
Contractor:	
Created by:	Verified by:
Date:	File: 012510-1TA_DATASEP
Page number:	Approved:

# MAP

## Sample Separation

### LEGEND

-  Line path
  -  Flag\_Separation
- Data exceeding max. data spacing: 1.2%

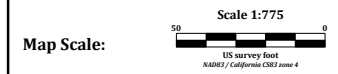

Client:	
Project:	
Contractor:	
Created by:	Verified by:
Date:	File: 012510-2TA_DATASEP
Page number:	Approved:

# MAP

## Sample Separation

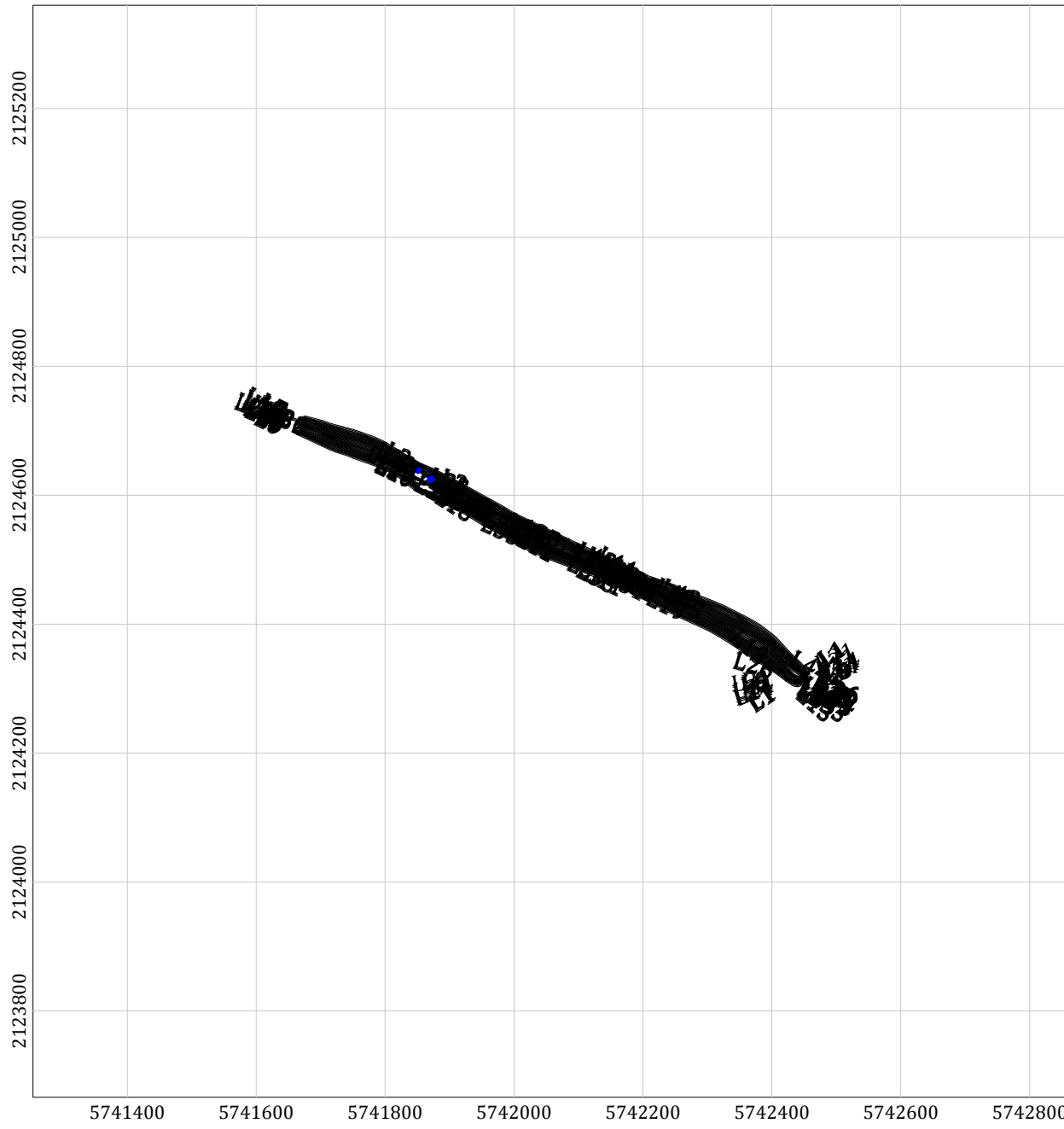

### LEGEND

Line path  
Flag\_Separation

Data exceeding max. data spacing: 0.0%

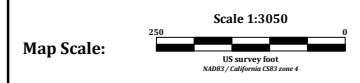



Client:	
Project:	
Contractor:	
Created by:	Verified by:
Date:	File: 012710-1TA_DATASEP
Page number:	Approved:

# MAP

## Sample Separation

### LEGEND

-  Line path
  -  Flag\_Separation
- Data exceeding max. data spacing: 0.4%

Map Scale:  Scale 1:625  
US survey foot  
 NAD83 / California CSRS zone 4

 N  
 Grid North: 0°0'0"  
 Mag North: 0°0'0"

Client:	
Project:	
Contractor:	
Created by:	Verified by:
Date:	File: 012710-2TA_DATASEP
Page number:	Approved:

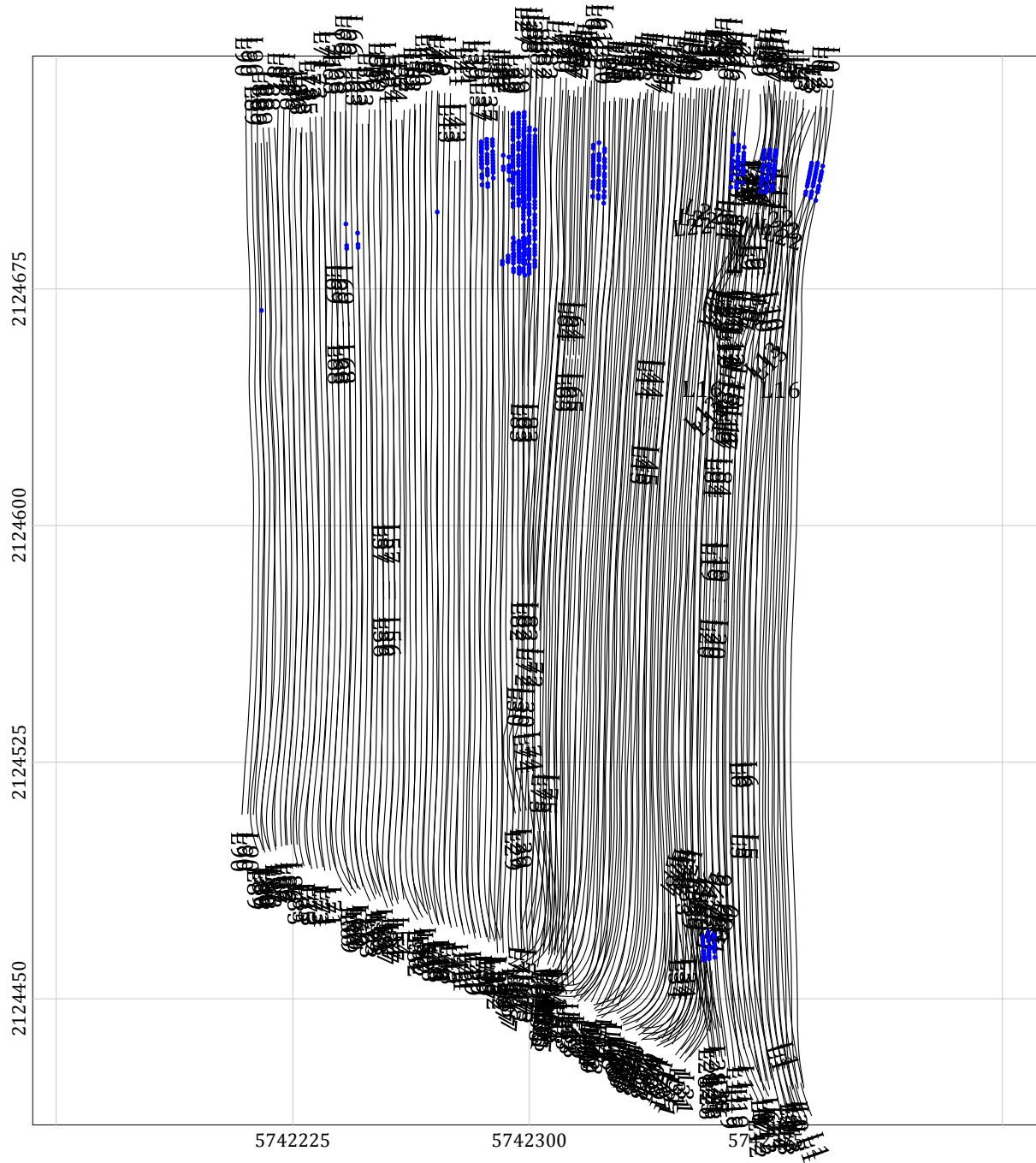



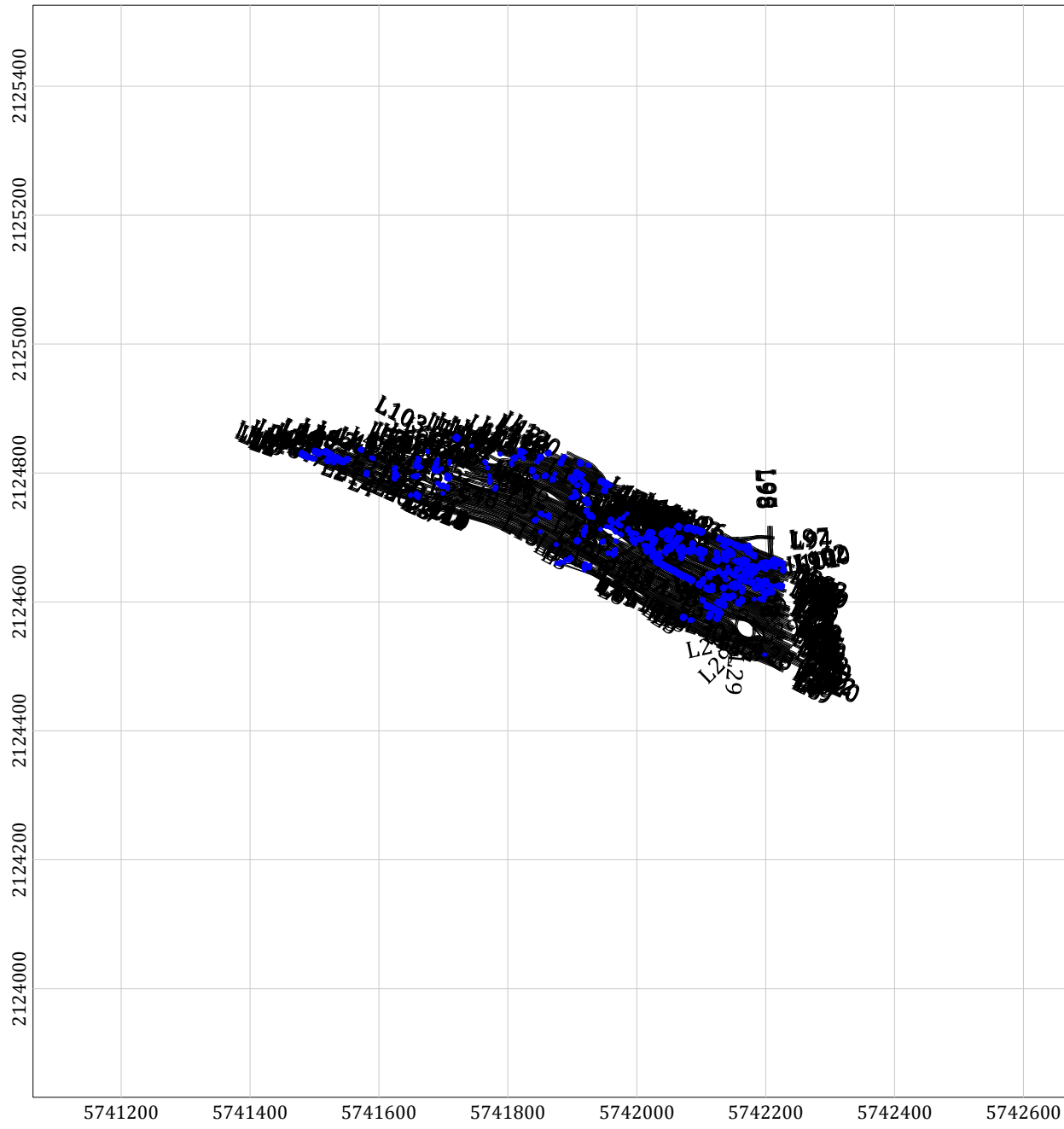

# MAP

## Sample Separation

### LEGEND

- Line path
  - Flag\_Separation
- Data exceeding max. data spacing: 1.1%

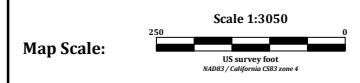

Client:	
Project:	
Contractor:	
Created by:	Verified by:
Date:	File: 012810-1TA_DATASEP
Page number:	Approved:

# MAP

## Sample Separation

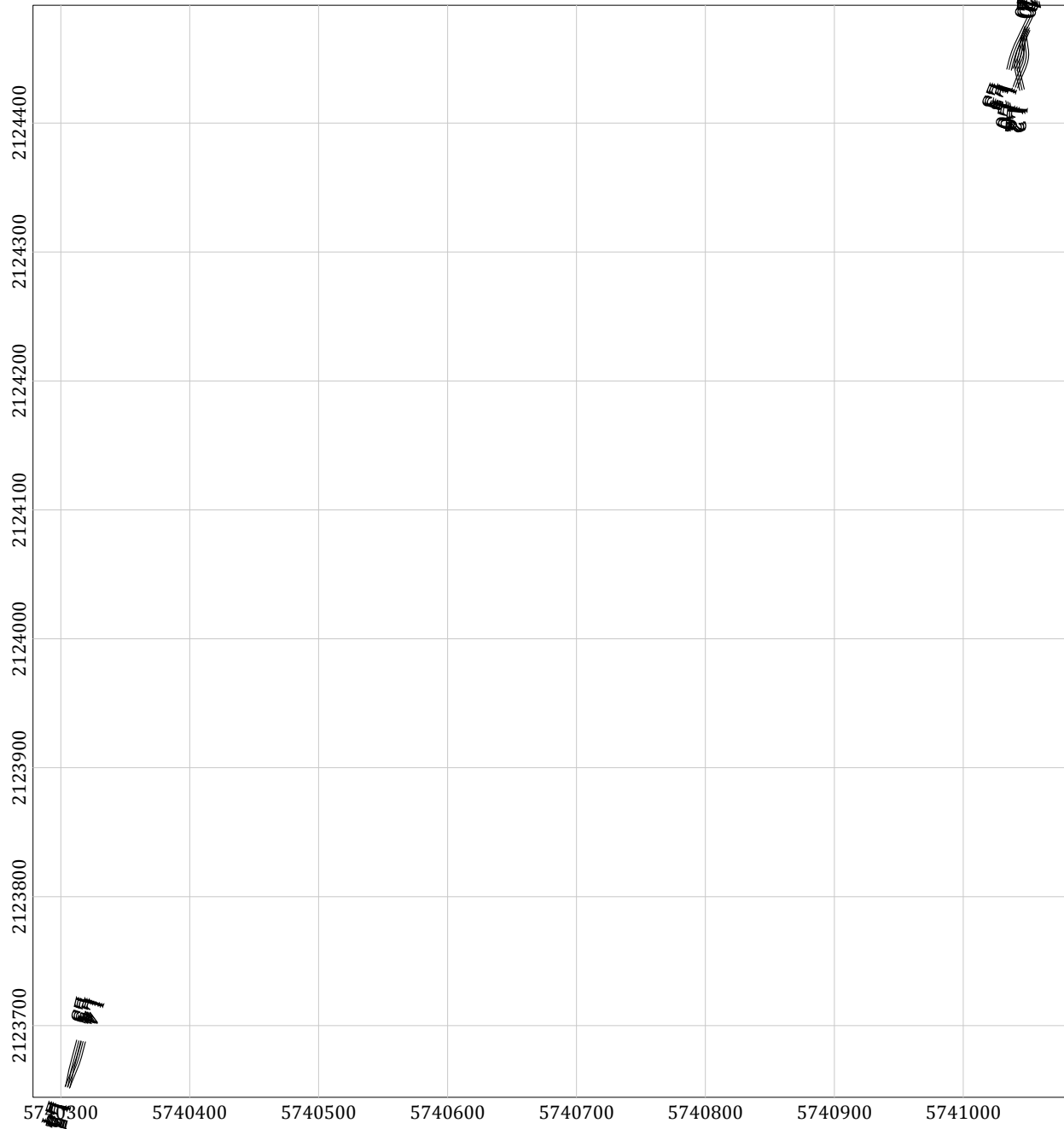

### LEGEND

- Line path
  - Flag\_Separation
- Data exceeding max. data spacing: 0.0%

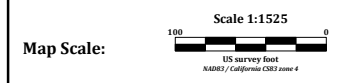



Client:	
Project:	
Contractor:	
Created by:	Verified by:
Date:	File: 012810-2TA_DATASEP
Page number:	Approved:

# MAP

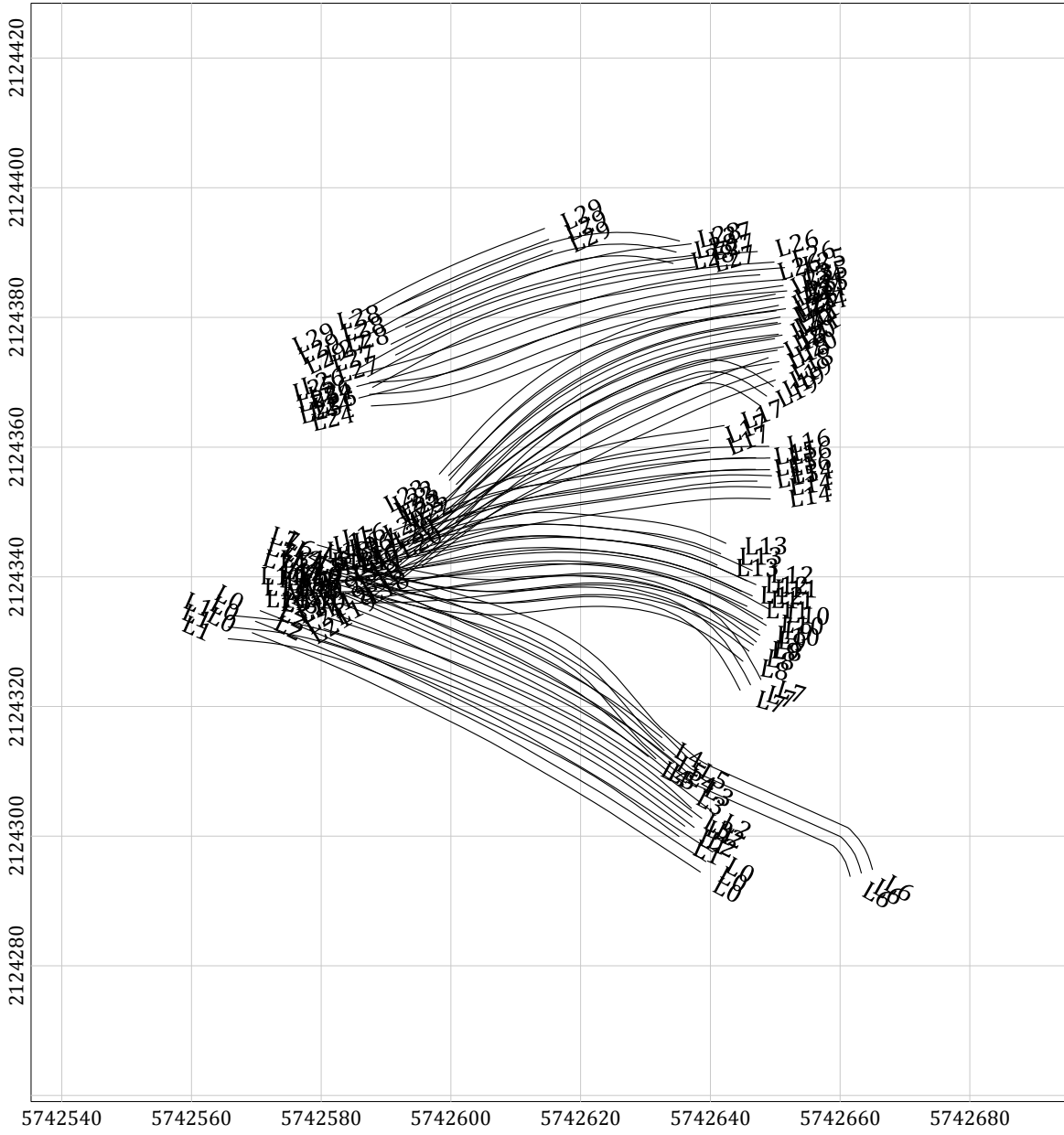
## Sample Separation



### LEGEND

 Line path  
 Flag\_Separation  
 Data exceeding max. data spacing: 0.0%

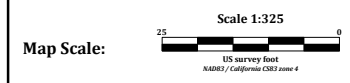

Client:	
Project:	
Contractor:	
Created by:	Verified by:
Date:	File: 012910-1TA_DATASEP
Page number:	Approved:

# MAP

## Sample Separation

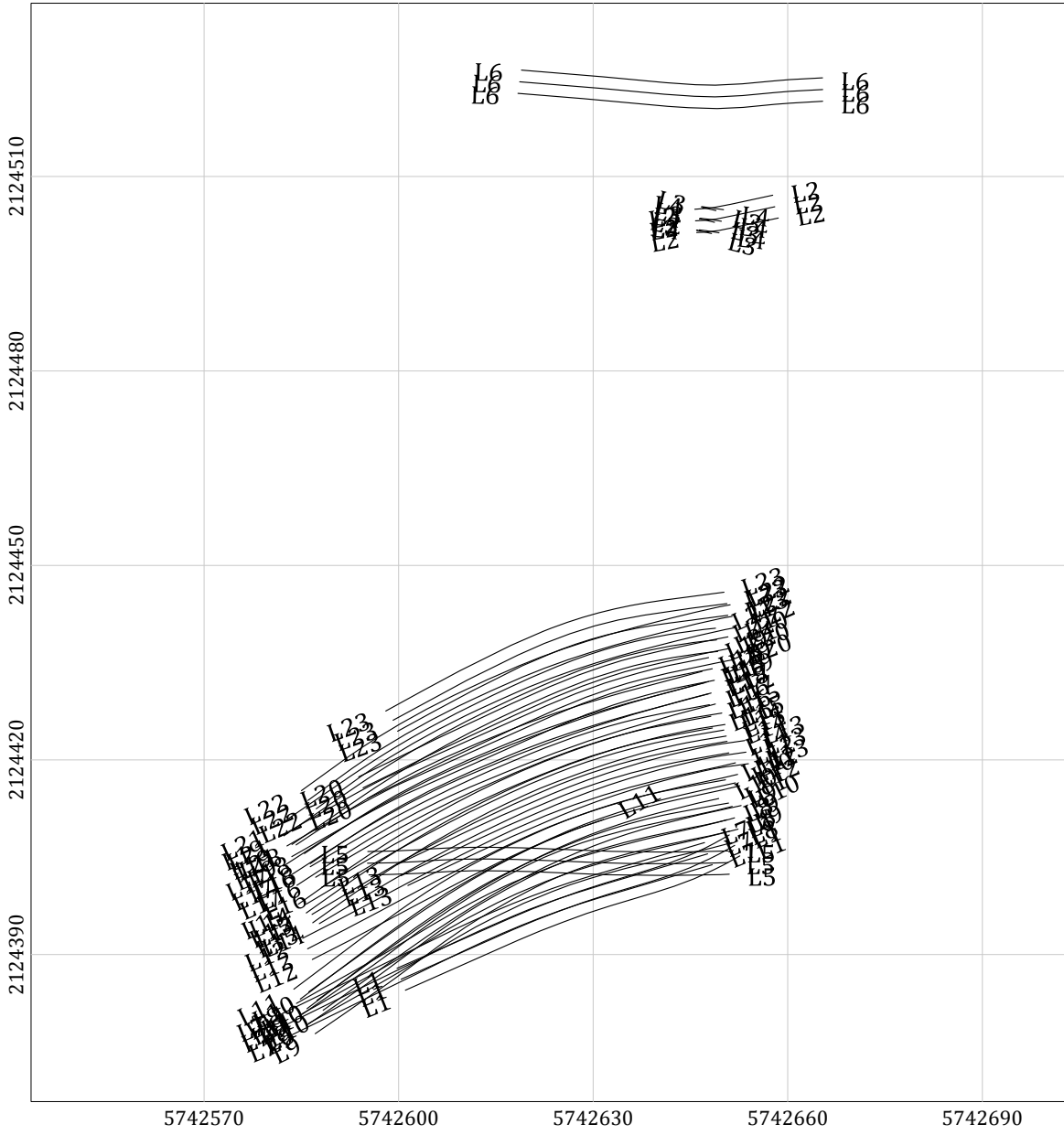

### LEGEND

-  Line path
  -  Flag Separation
- Data exceeding max. data spacing: 0.0%

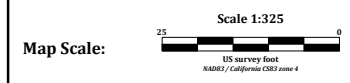



Client:	
Project:	
Contractor:	
Created by:	Verified by:
Date:	File: 012910-2TA_DATASEP
Page number:	Approved:

# MAP

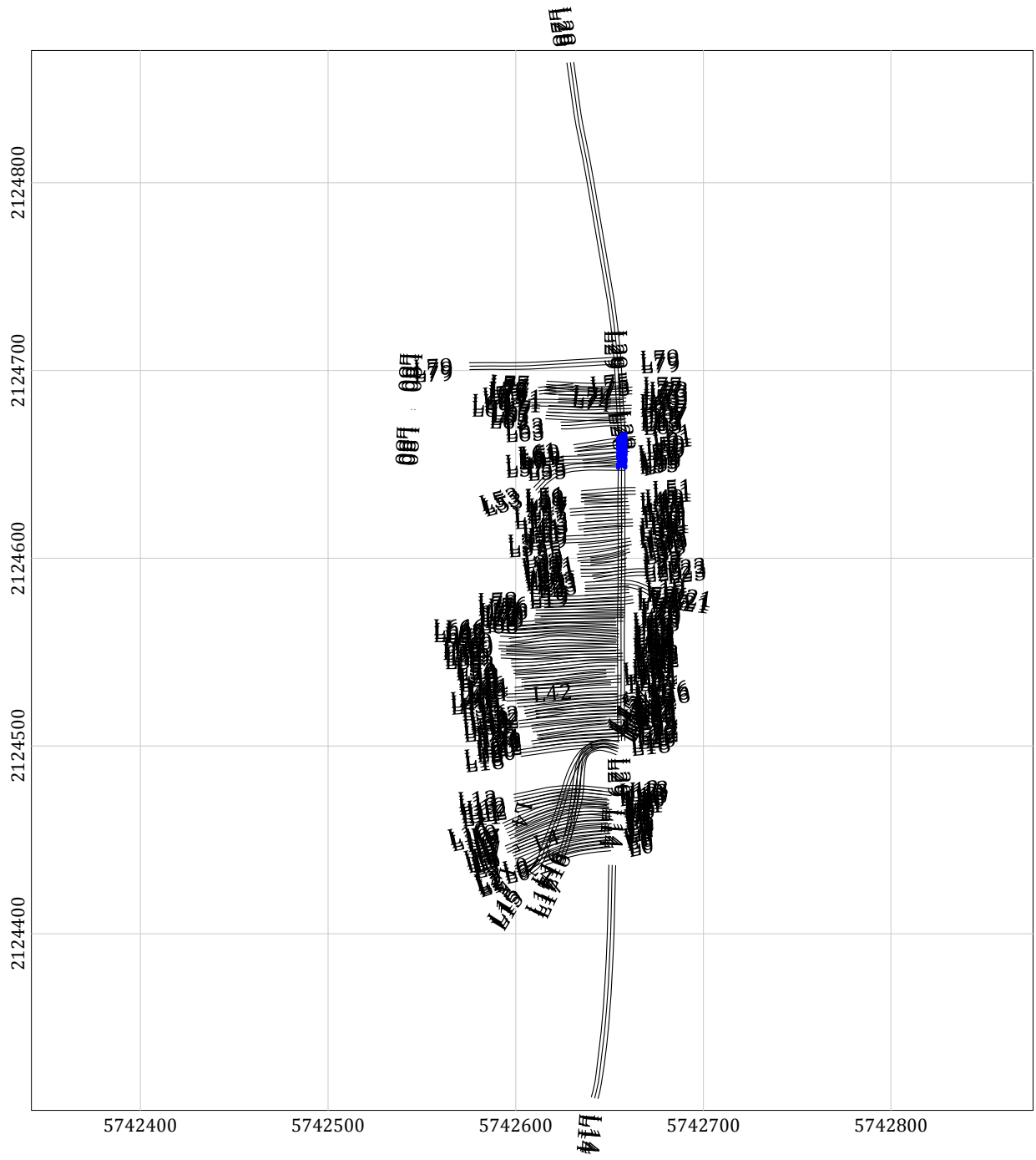
## Sample Separation



### LEGEND

-  Line path
  -  Flag Separation
- Data exceeding max. data spacing: 0.1%



Client:	
Project:	
Contractor:	
Created by:	Verified by:
Date:	File: 012910-3TA_DATASEP
Page number:	Approved:

# MAP

## Sample Separation

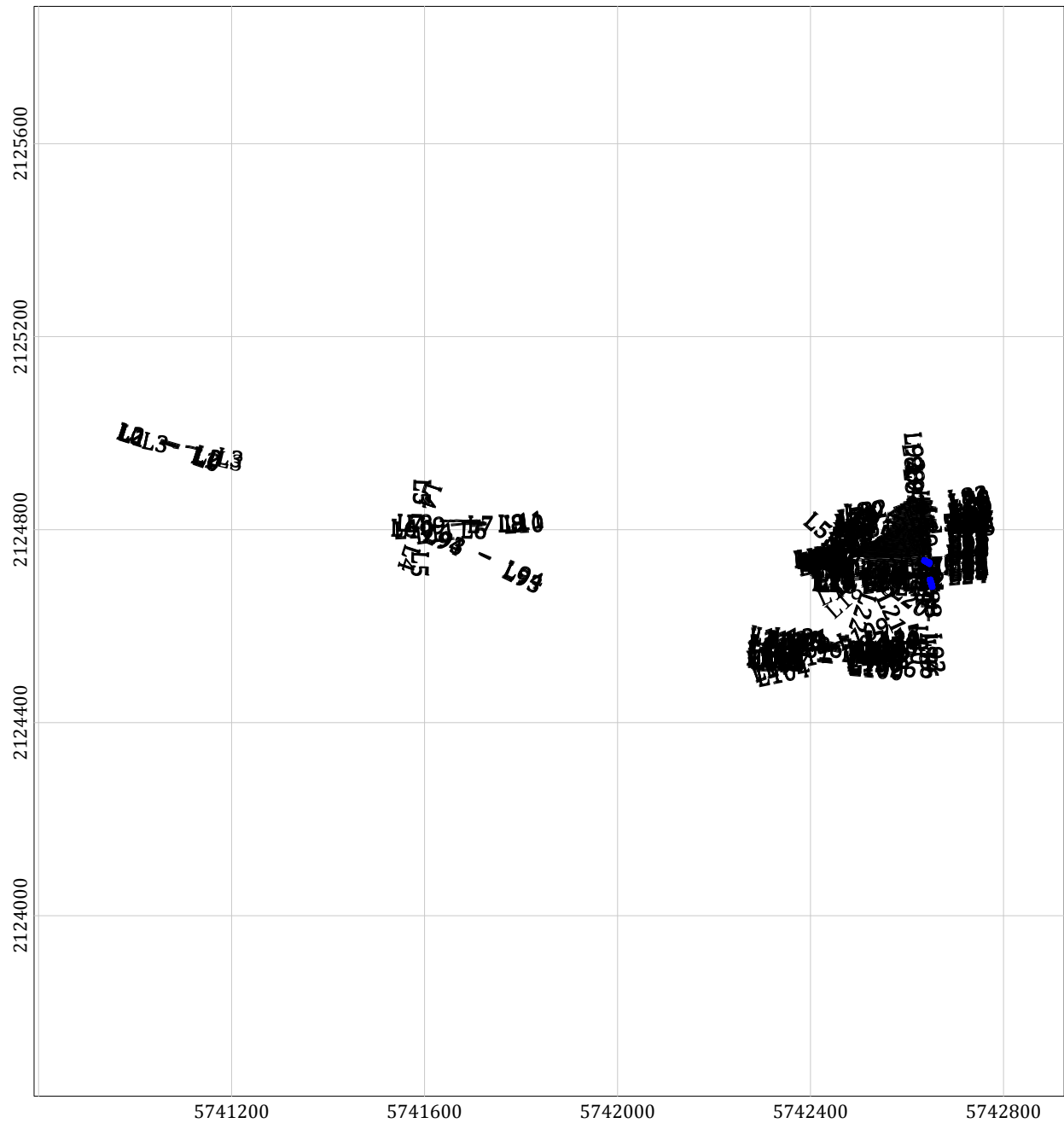

### LEGEND

- Line path
  - Flag\_Separation
- Data exceeding max. data spacing: 0.2%



Client:	
Project:	
Contractor:	
Created by:	Verified by:
Date:	File: 020210-1TA_DATASEP
Page number:	Approved:

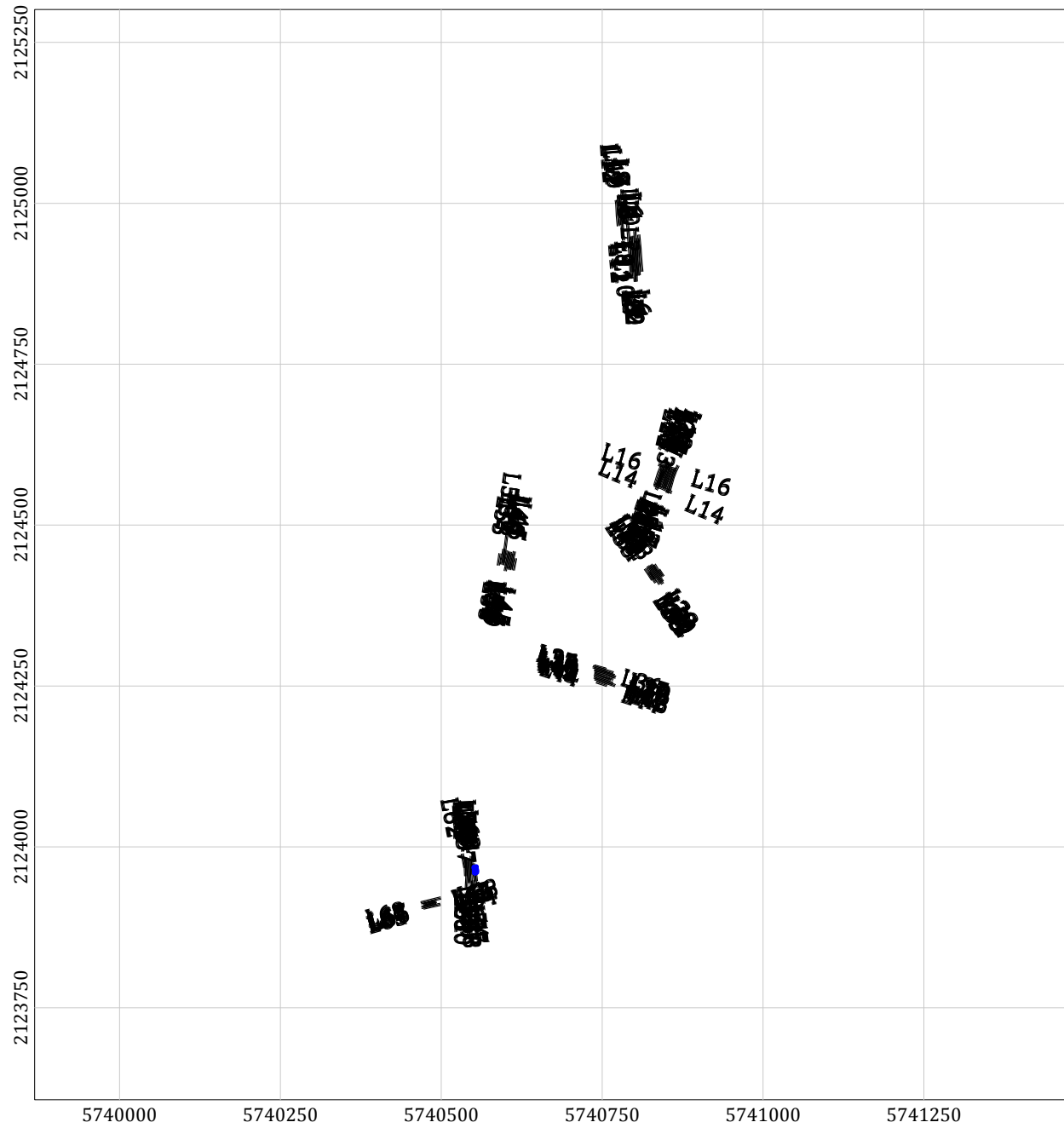

# MAP

## Sample Separation

### LEGEND

- Line path
  - Flag\_Separation
- Data exceeding max. data spacing: 0.2%

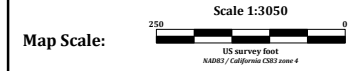

Client:	
Project:	
Contractor:	
Created by:	Verified by:
Date:	File: 020210-2TA_DATASEP
Page number:	Approved:

# MAP

## Sample Separation

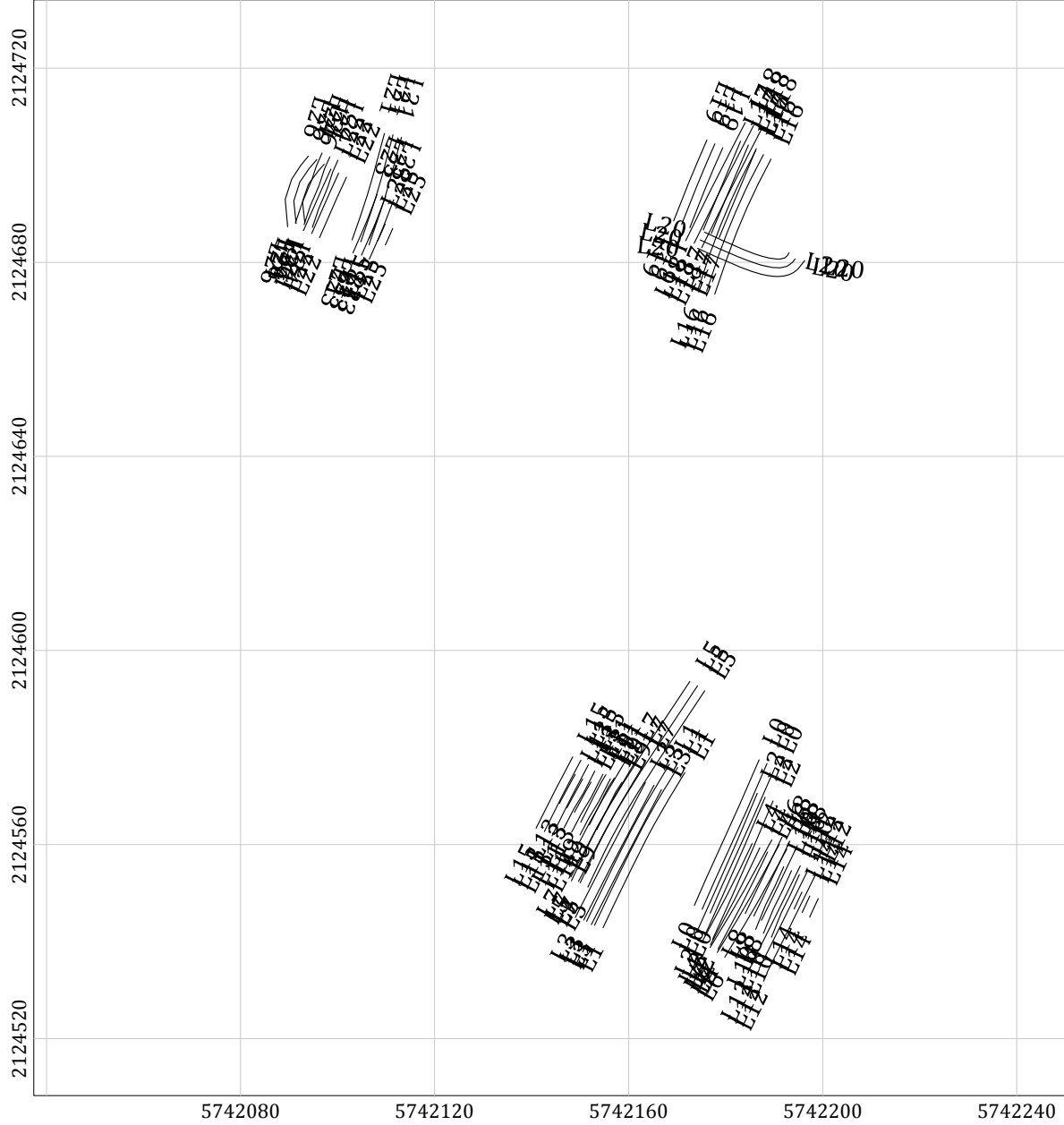

### LEGEND

-  Line path
  -  Flag Separation
- Data exceeding max. data spacing: 0.0%

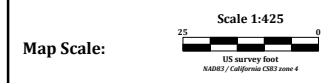

Client:	
Project:	
Contractor:	
Created by:	Verified by:
Date:	File: 020210-3TA_DATASEP
Page number:	Approved:



# MAP

## Sample Separation

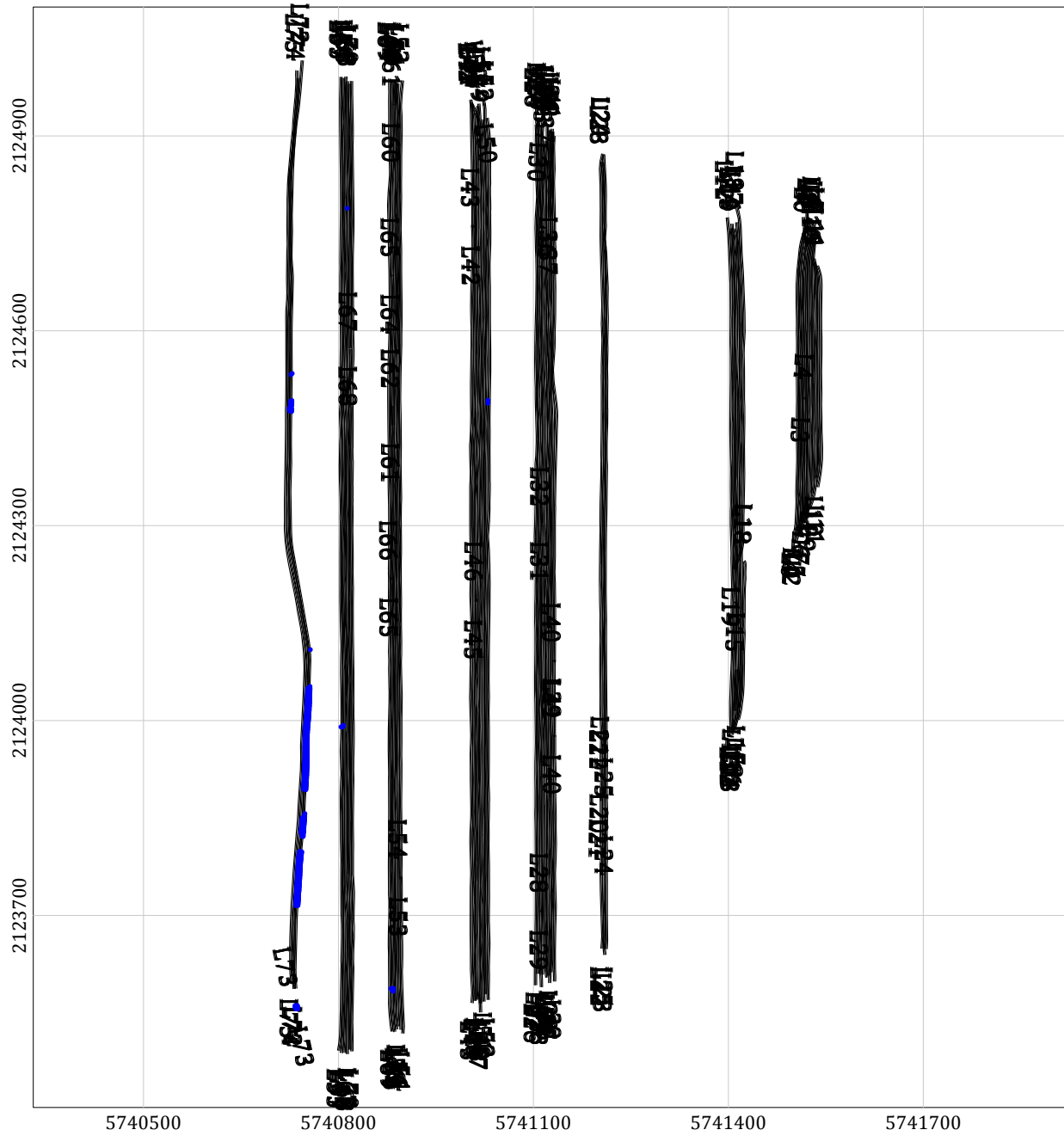

### LEGEND

-  Line path
  -  Flag Separation
- Data exceeding max. data spacing: 0.2%

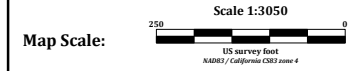

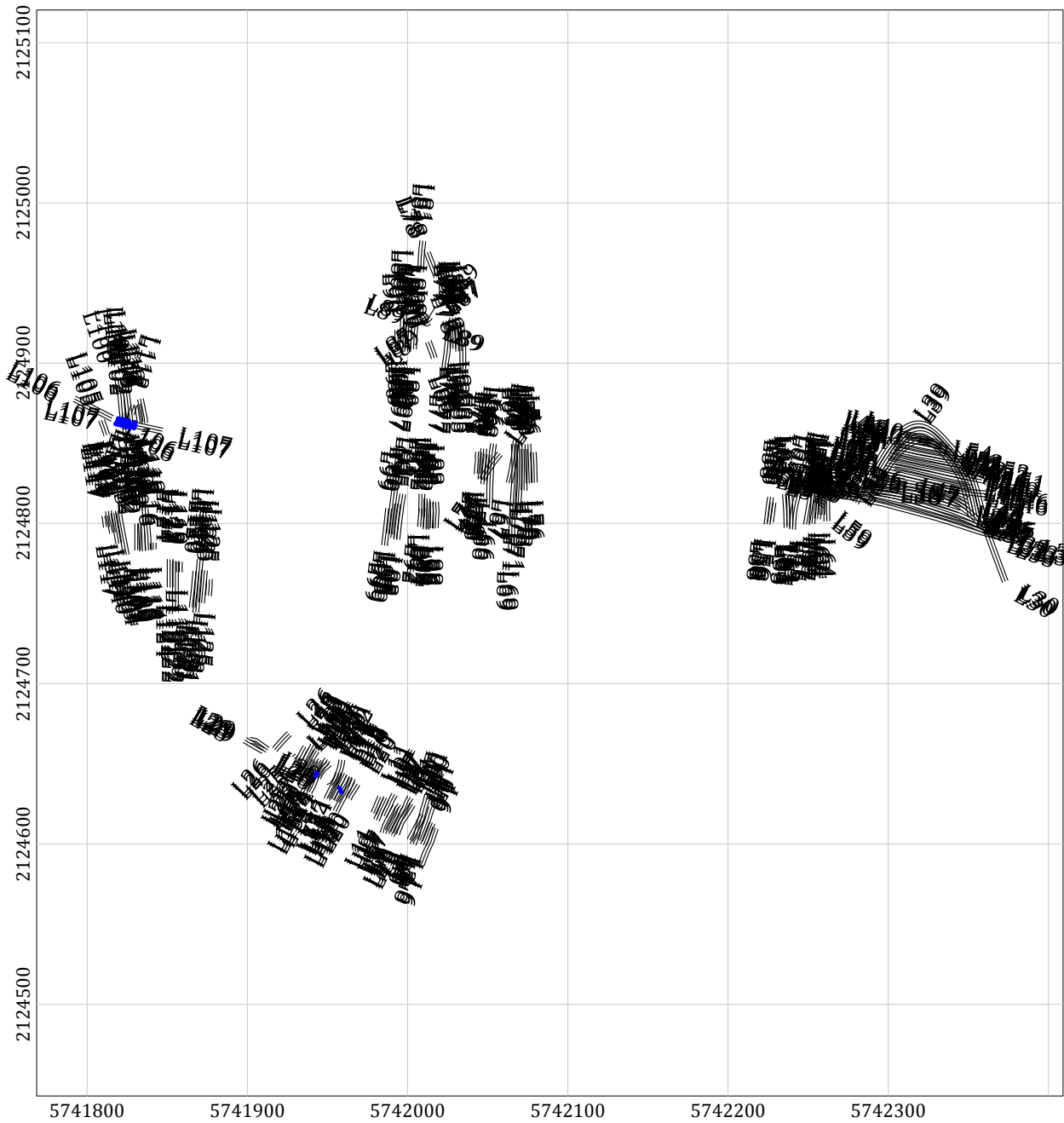

Client:	
Project:	
Contractor:	
Created by:	Verified by:
Date:	File: 020310-1TA_DATASEP
Page number:	Approved:



# MAP

## Sample Separation

### LEGEND

-  Line path
  -  Flag\_Separation
- Data exceeding max. data spacing: 0.1%

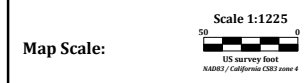

Client:	
Project:	
Contractor:	
Created by:	Verified by:
Date:	File: 020410-1TA_DATASEP
Page number:	Approved:

# MAP

## Sample Separation

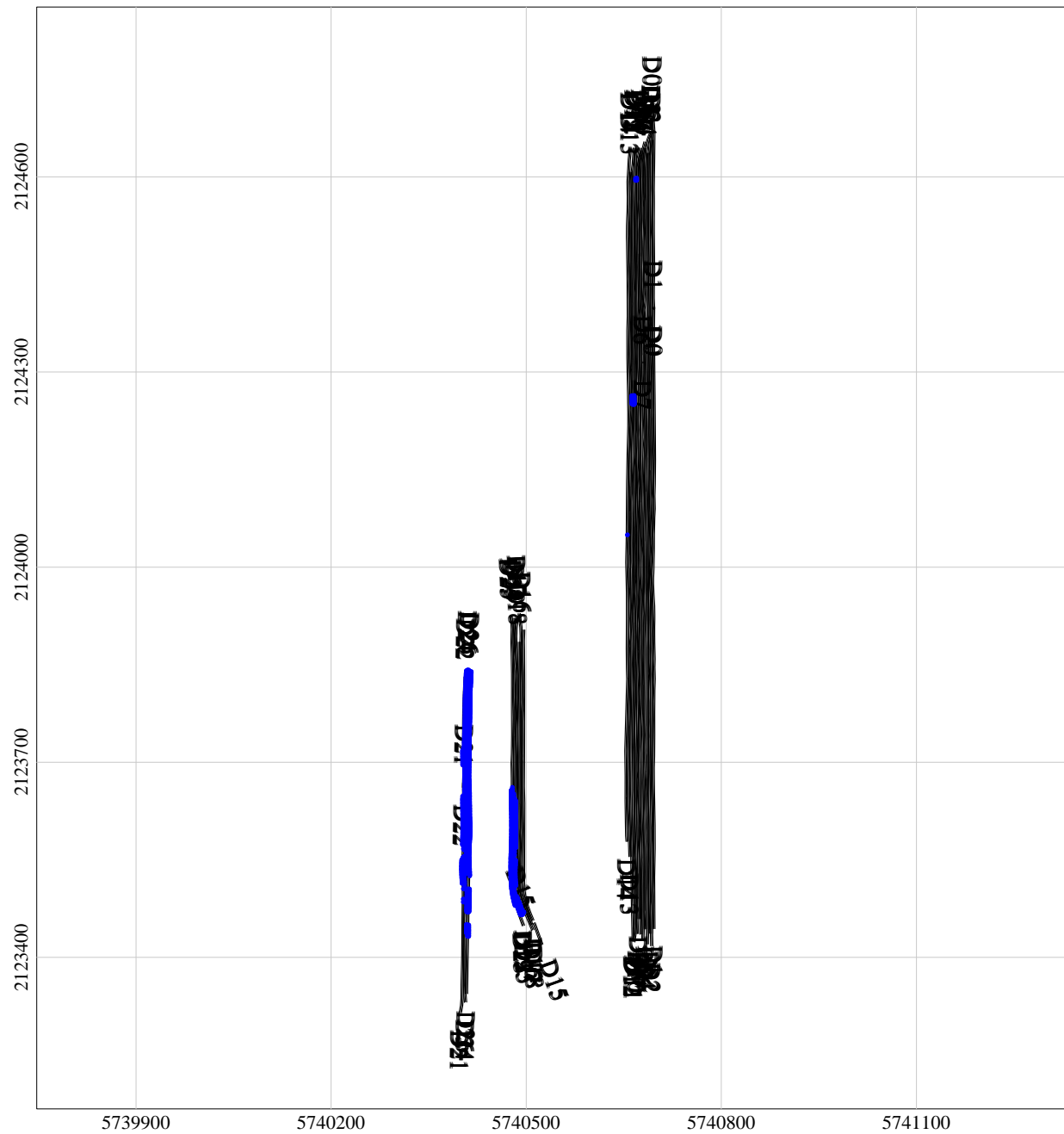

### LEGEND

- Line path
  - Flag Separation
- Data exceeding max. data spacing: 1.9%

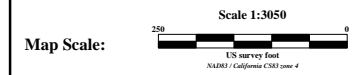

Client:	
Project:	
Contractor:	
Created by:	Verified by:
Date:	File: 020510-1TA_DATASEP
Page number:	Approved:

# MAP

## Sample Separation

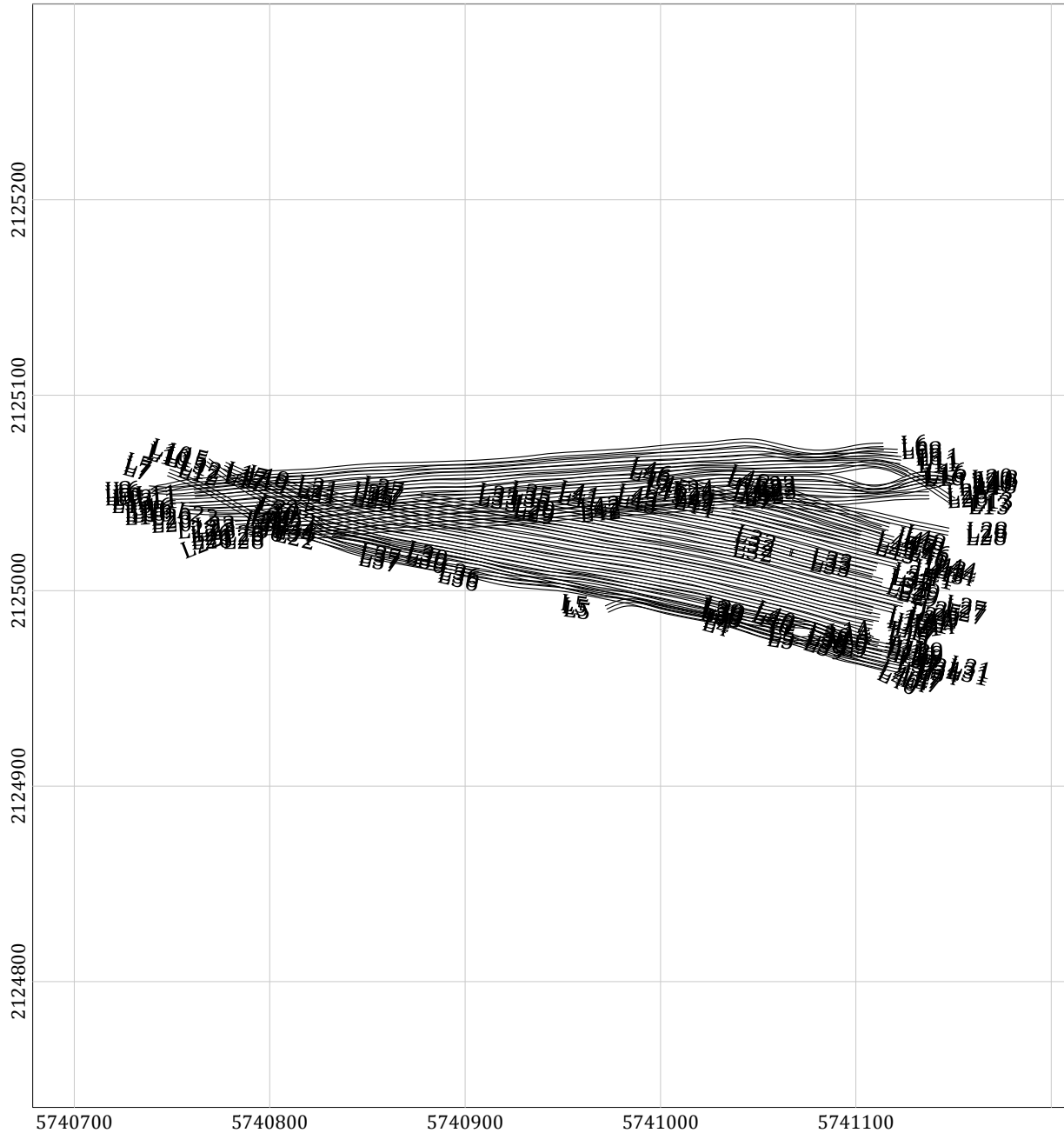

### LEGEND

- Line path
  - Flag\_Separation
- Data exceeding max. data spacing: 0.0%





Client:	
Project: Fort Ord- Parker Flats	
Contractor:	
Created by:	Verified by:
Date:	File: 011110-1TA_DATASEP
Page number:	Approved:

# MAP

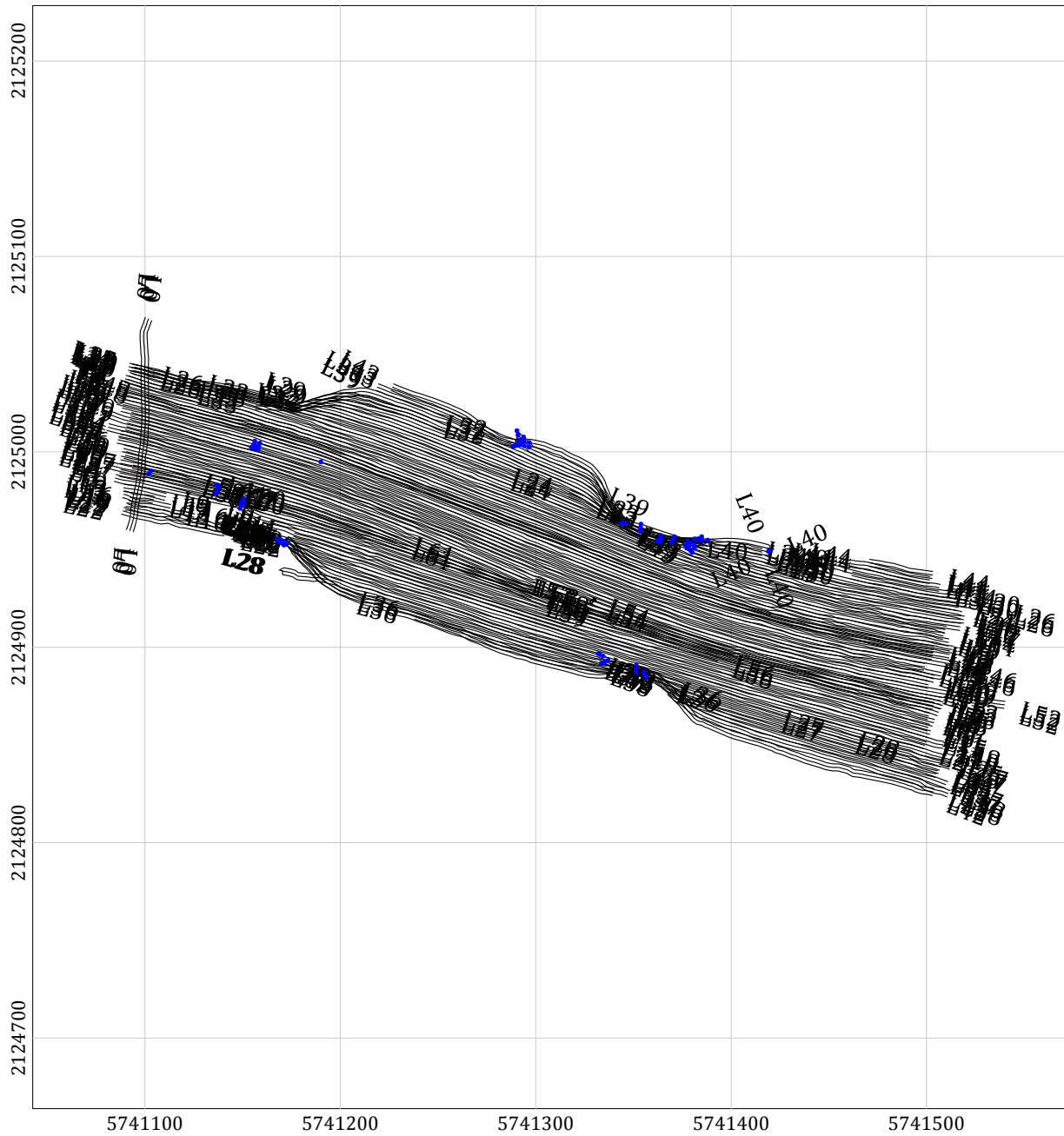
## Sample Separation



### LEGEND

-  Line path
  -  Flag Separation
- Data exceeding max. data spacing: 0.1%



Client:	
Project:	
Contractor:	
Created by:	Verified by:
Date:	File: 011210-1TA_DATASEP
Page number:	Approved:

# MAP

## Sample Separation

### LEGEND

- Line path
  - Flag\_Separation
- Data exceeding max. data spacing: 0.1%

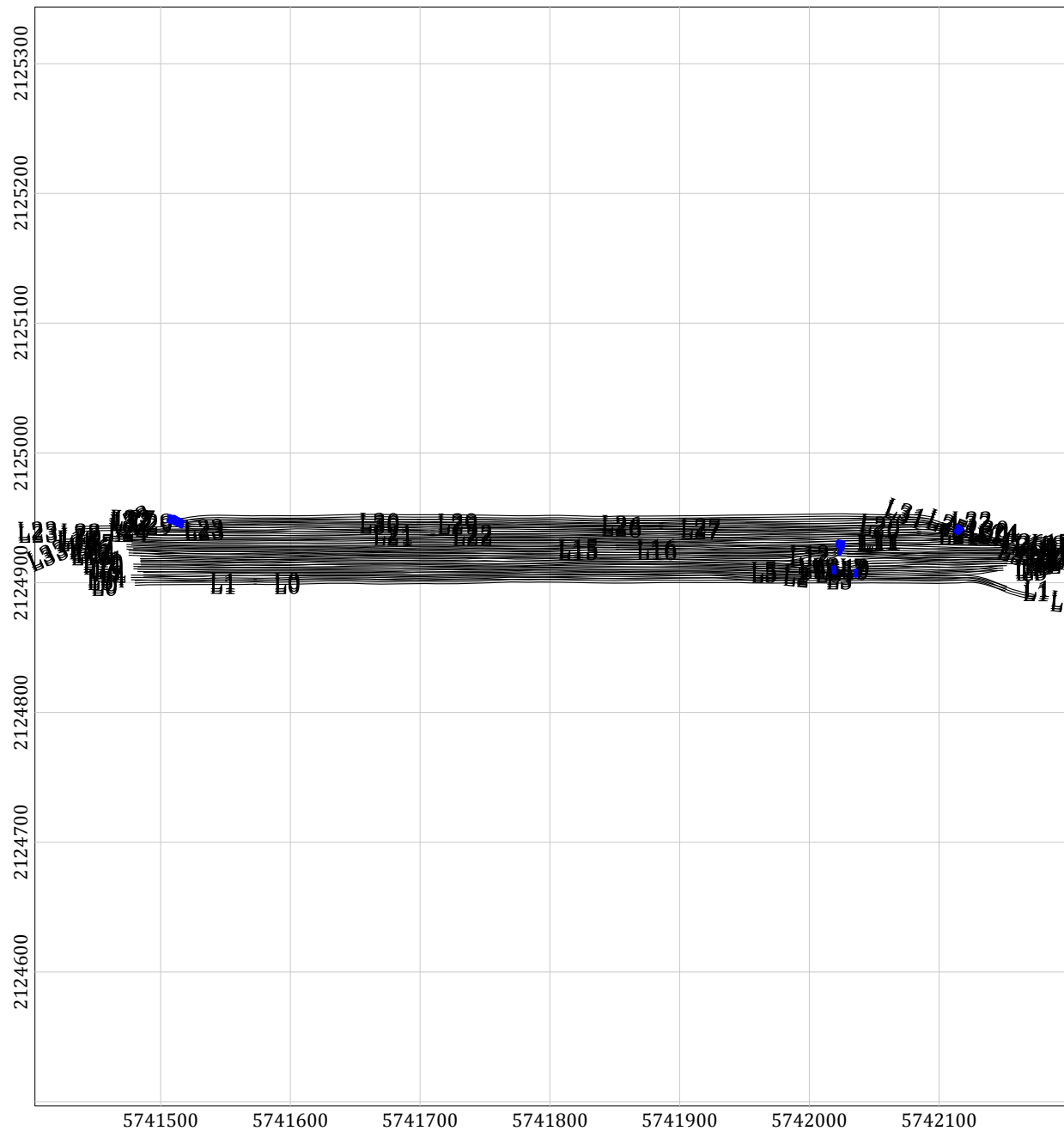
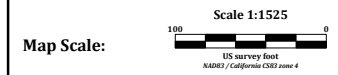

Client:	
Project:	
Contractor:	
Created by:	Verified by:
Date:	File: 011210-2TA_DATASEP
Page number:	Approved:

# MAP

## Sample Separation

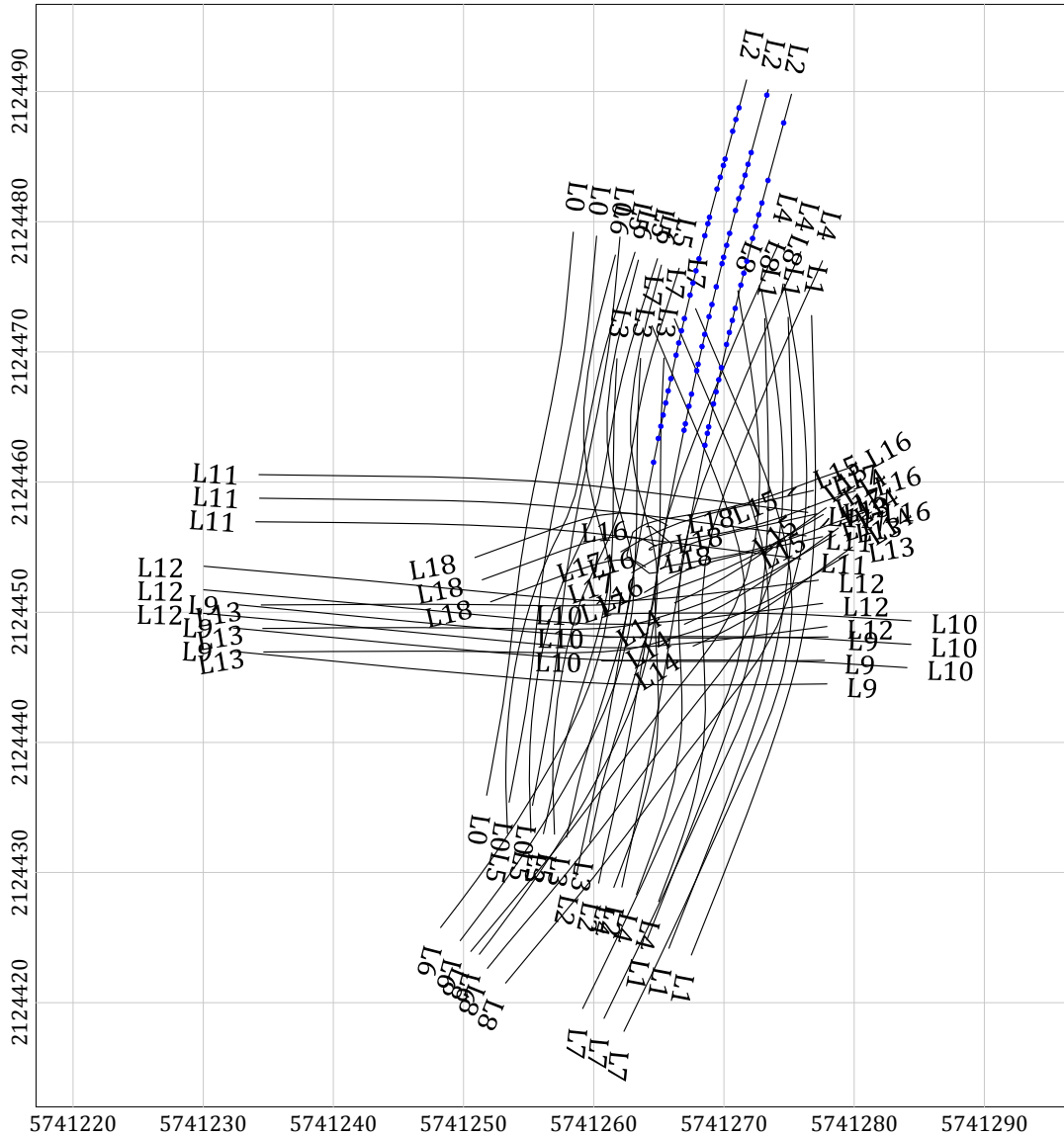

### LEGEND

- Line path
  - Flag Separation
- Data exceeding max. data spacing: 0.8%



Client:	
Project:	
Contractor:	
Created by:	Verified by:
Date:	File: 011310-1TA_DATASEP
Page number:	Approved:

# MAP

## Sample Separation

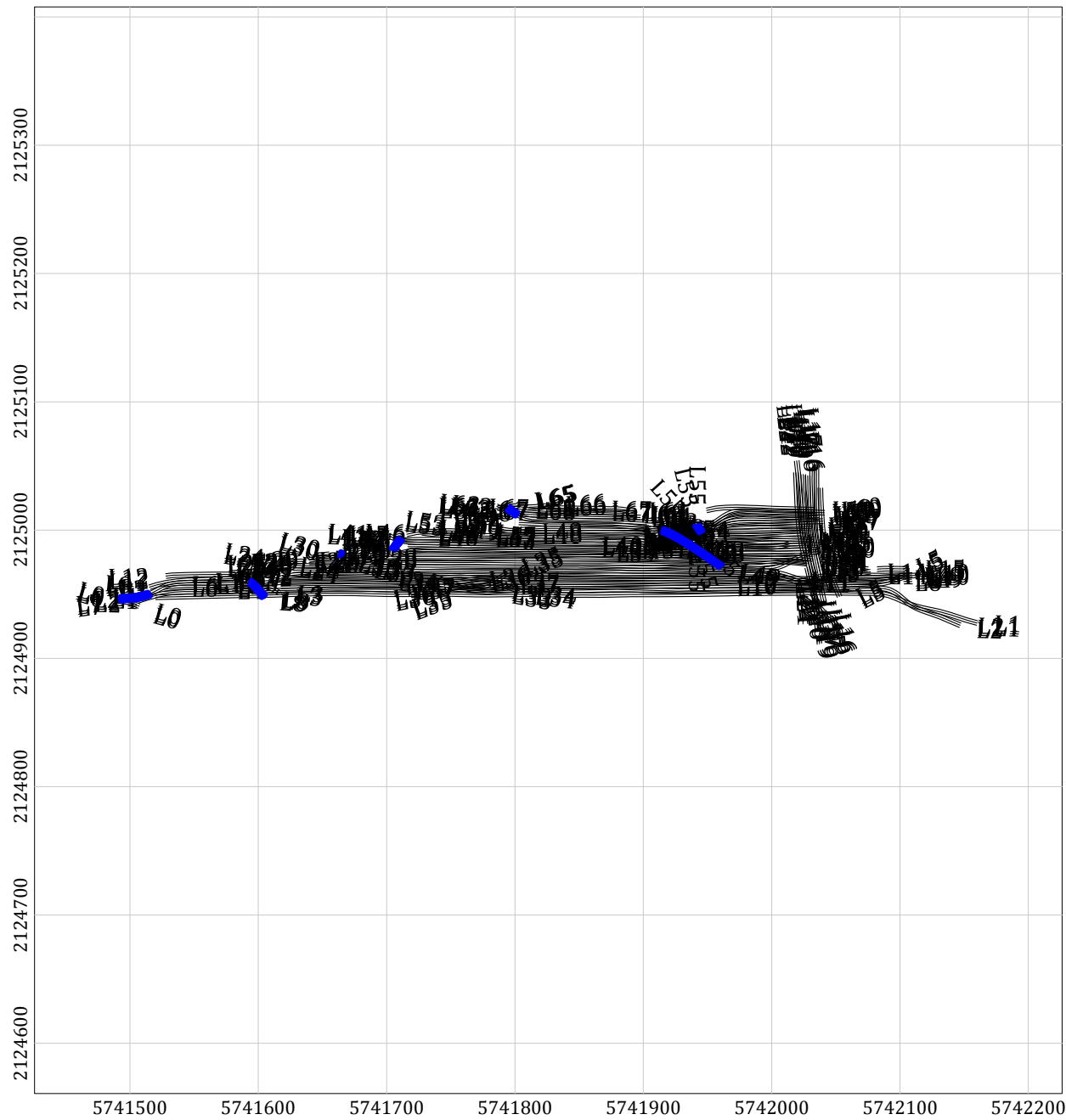

### LEGEND

- Line path
  - Flag\_Separation
- Data exceeding max. data spacing: 0.4%

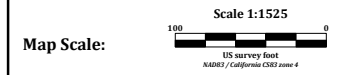

Client:	
Project:	
Contractor:	
Created by:	Verified by:
Date:	File: 011410-1TA_DATASEP
Page number:	Approved:



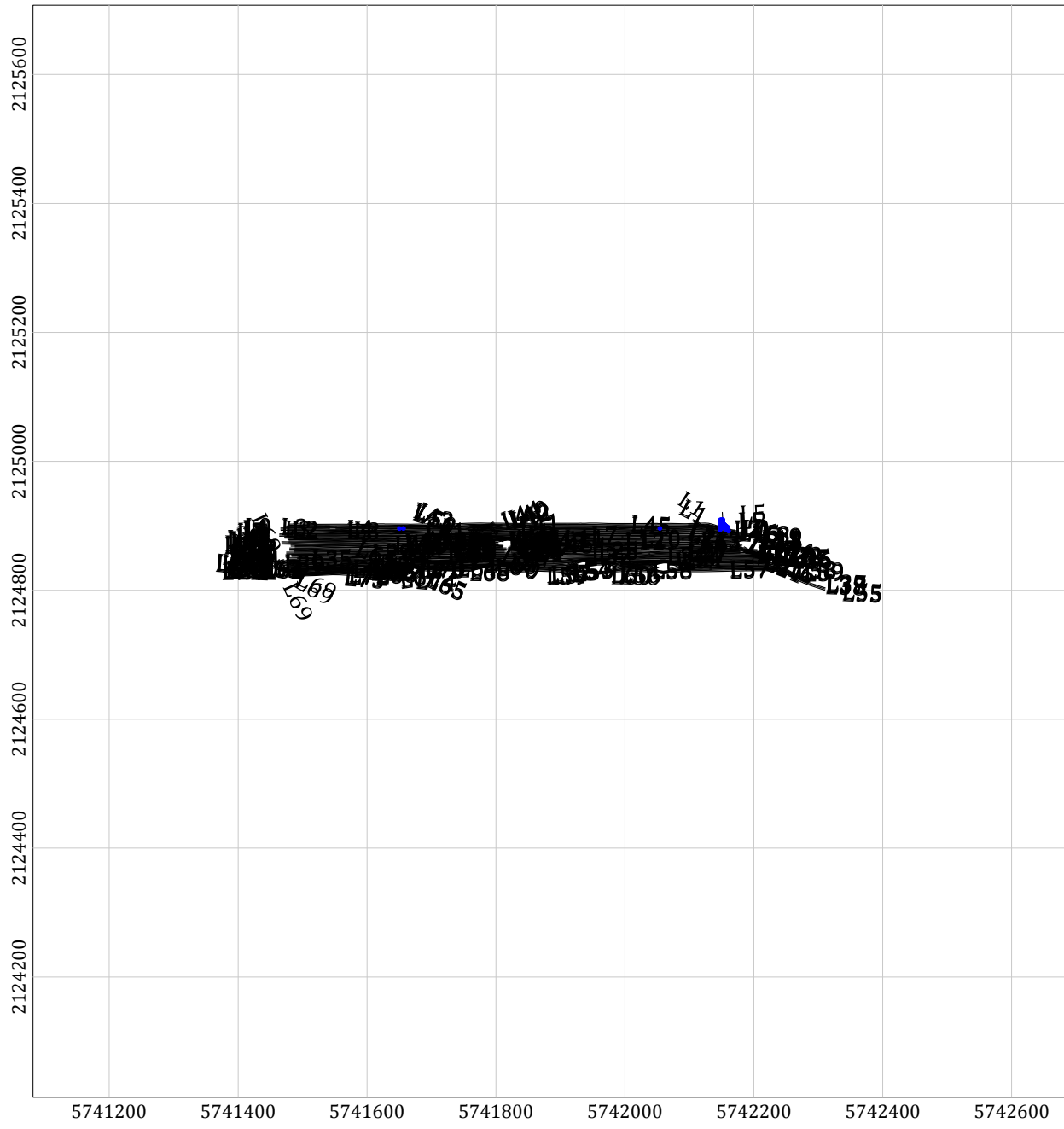



# MAP

## Sample Separation

### LEGEND

-  Line path
  -  Flag Separation
- Data exceeding max. data spacing: 0.1%

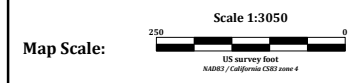

Client:	
Project:	
Contractor:	
Created by:	Verified by:
Date:	File: 011410-2TA_DATASEP
Page number:	Approved:

# MAP

## Sample Separation

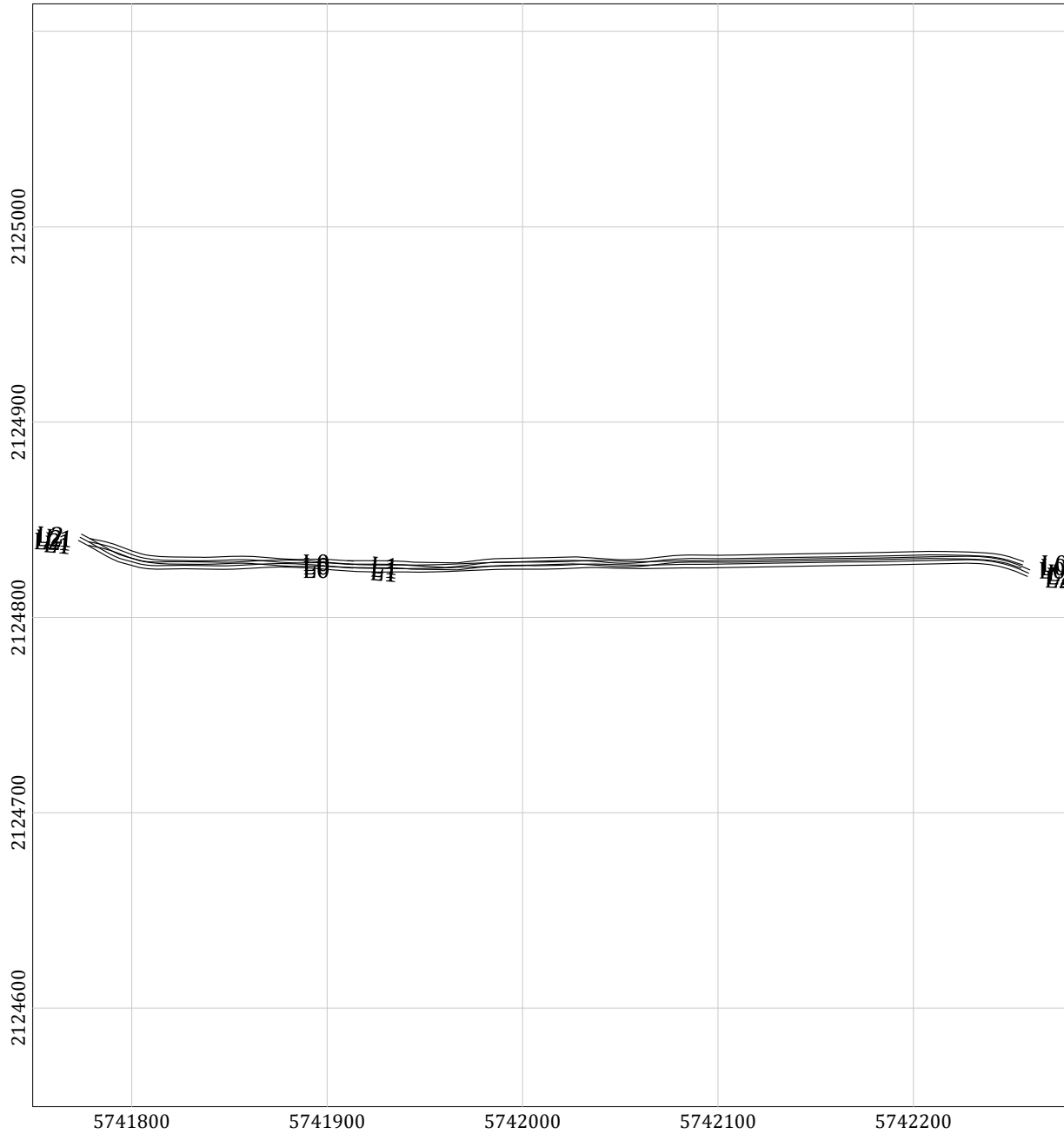

### LEGEND

- Line path
- Flag\_Separation

Data exceeding max. data spacing: 0.0%



Client:	
Project:	
Contractor:	
Created by:	Verified by:
Date:	File: 011810-1TA_DATASEP
Page number:	Approved:

# MAP

## Sample Separation

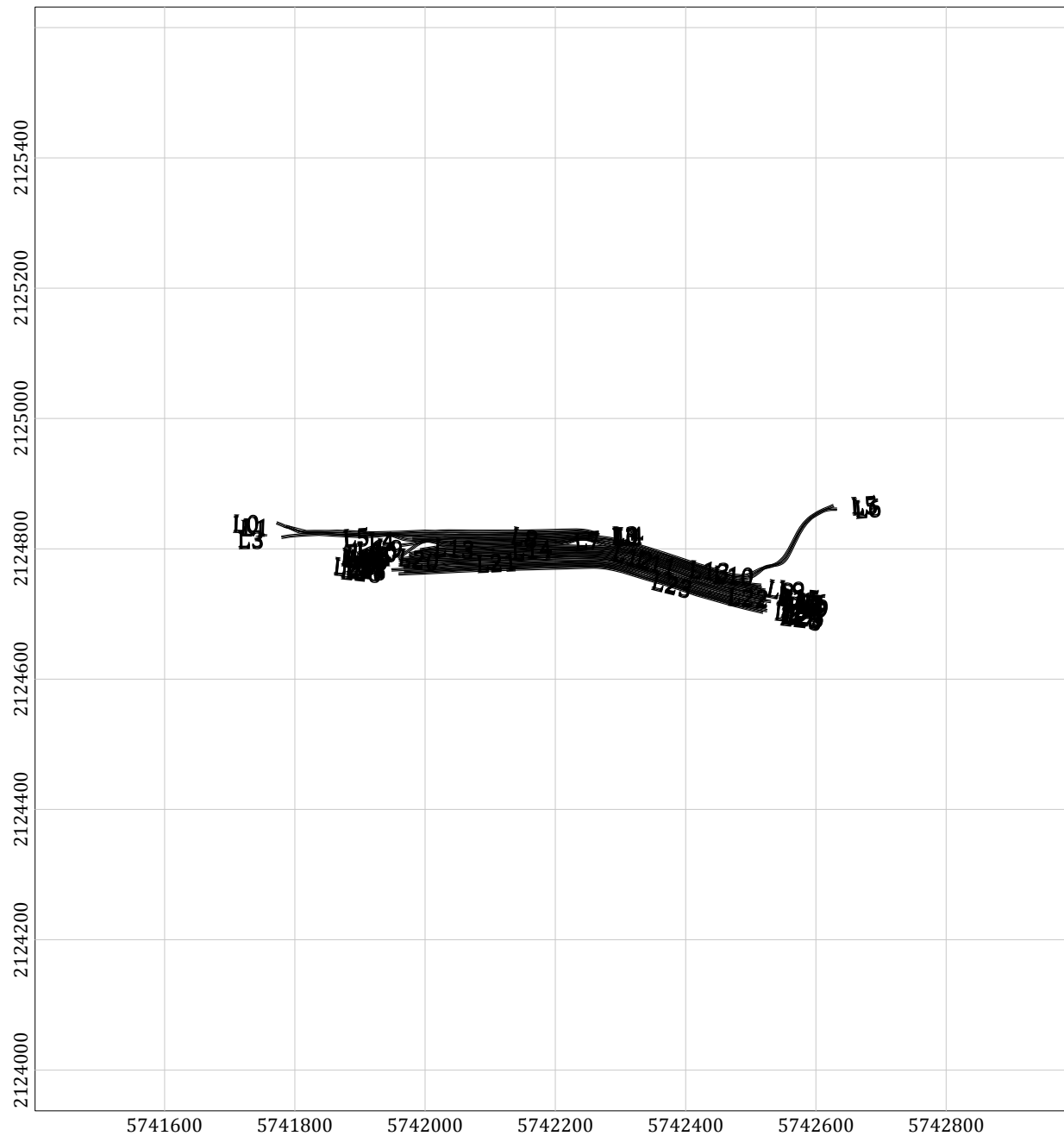

### LEGEND

Line path  
Flag\_Separation

Data exceeding max. data spacing: 0.0%

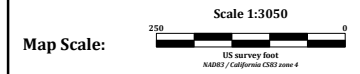

Client:

Project:

Contractor:

Created by: \_\_\_\_\_ Verified by: \_\_\_\_\_

Date: \_\_\_\_\_ File: 011810-2TA\_DATASEP

Page number: \_\_\_\_\_ Approved: \_\_\_\_\_

# MAP

## Sample Separation

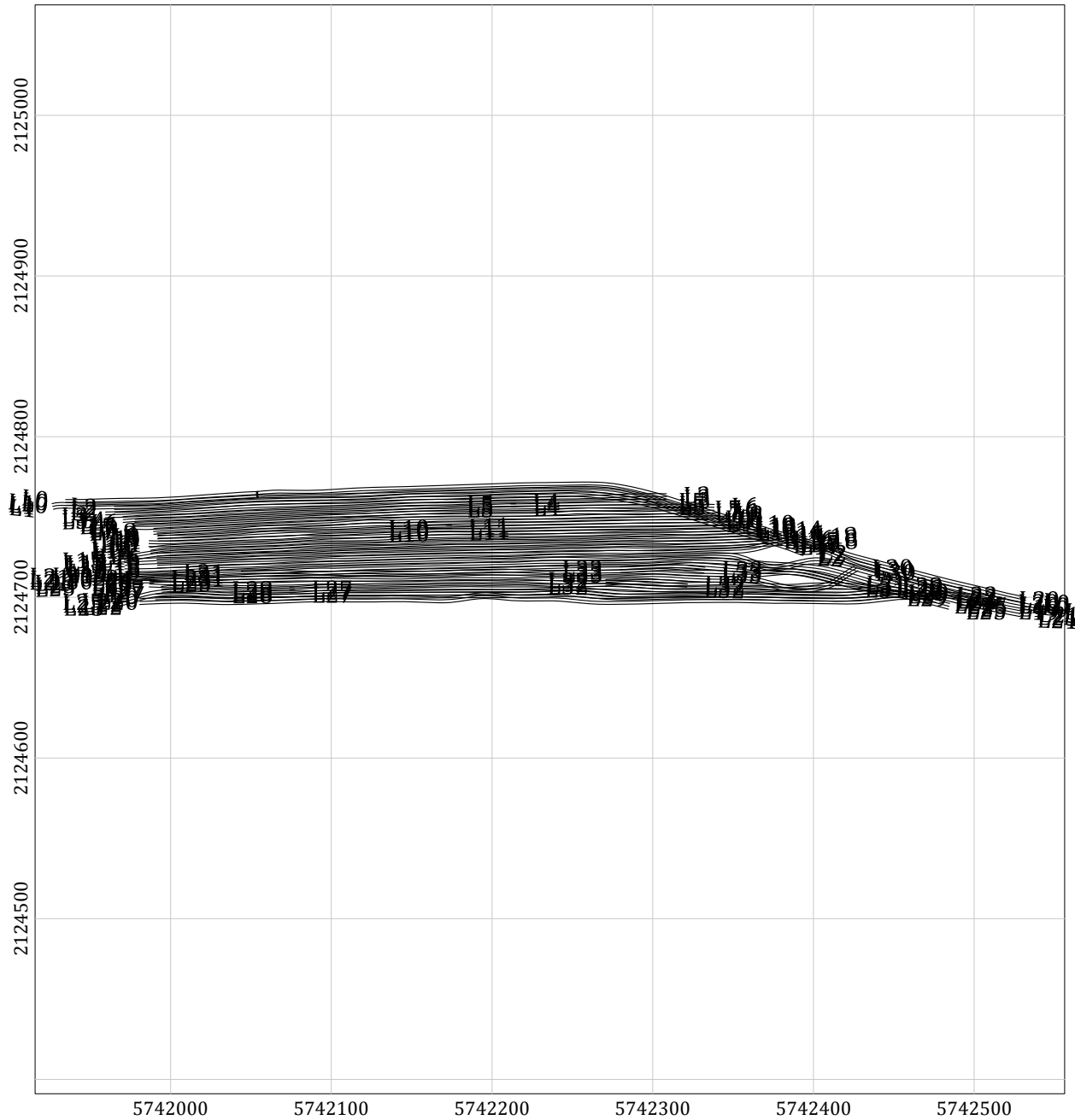

### LEGEND

- Line path
- Flag\_Separation

Data exceeding max. data spacing: 0.0%



Client:

Project:

Contractor:

Created by: \_\_\_\_\_ Verified by: \_\_\_\_\_

Date: \_\_\_\_\_ File: 012010-1TA\_DATASEP

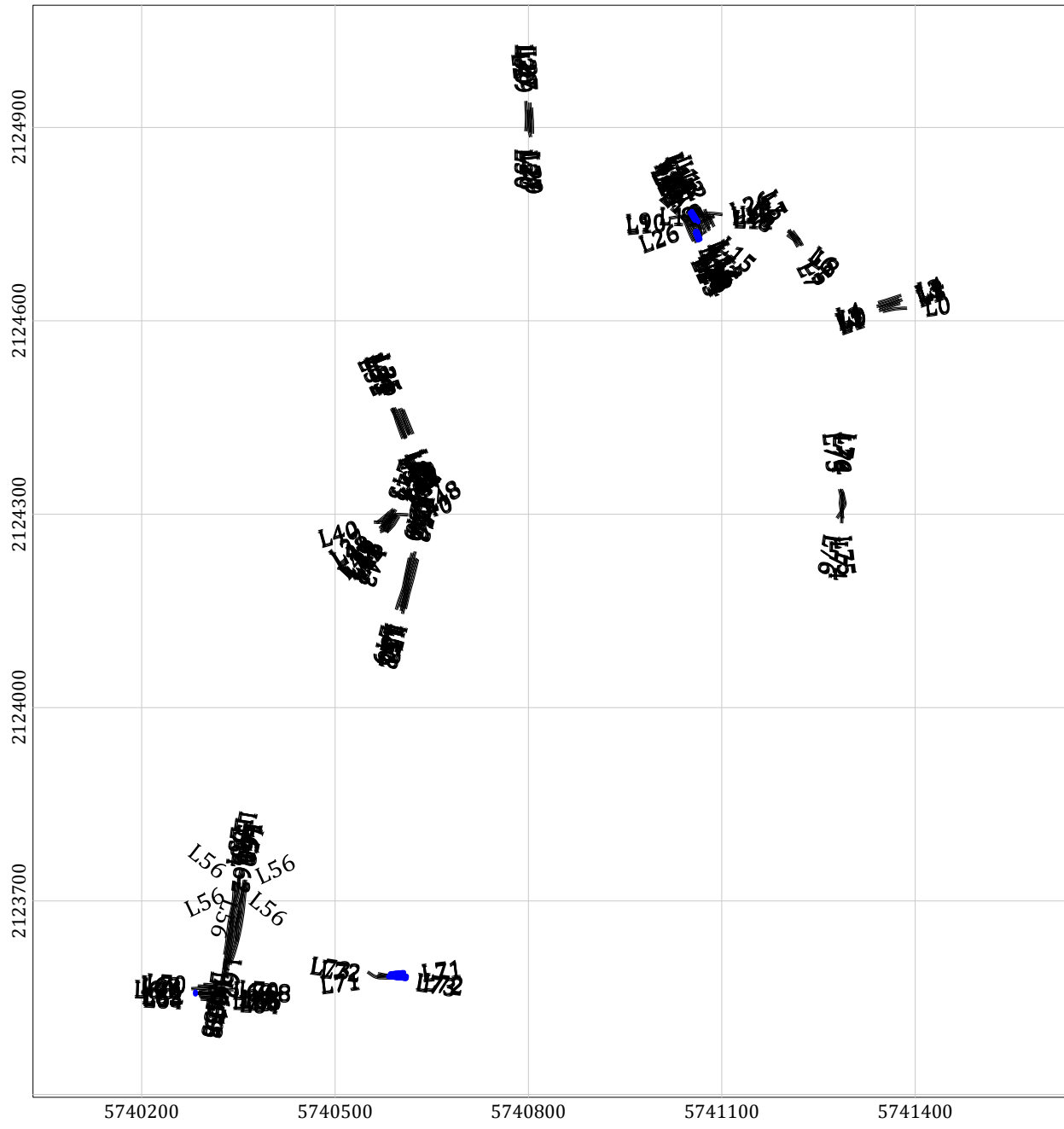

Page number: \_\_\_\_\_ Approved: \_\_\_\_\_



# MAP

## Sample Separation

### LEGEND

-  Line path
  -  Flag\_Separation
- Data exceeding max. data spacing: 0.8%

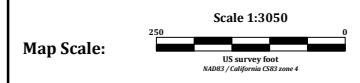



Client:	
Project:	
Contractor:	
Created by:	Verified by:
Date:	File: 012210-1TA_DATASEP
Page number:	Approved:

# MAP

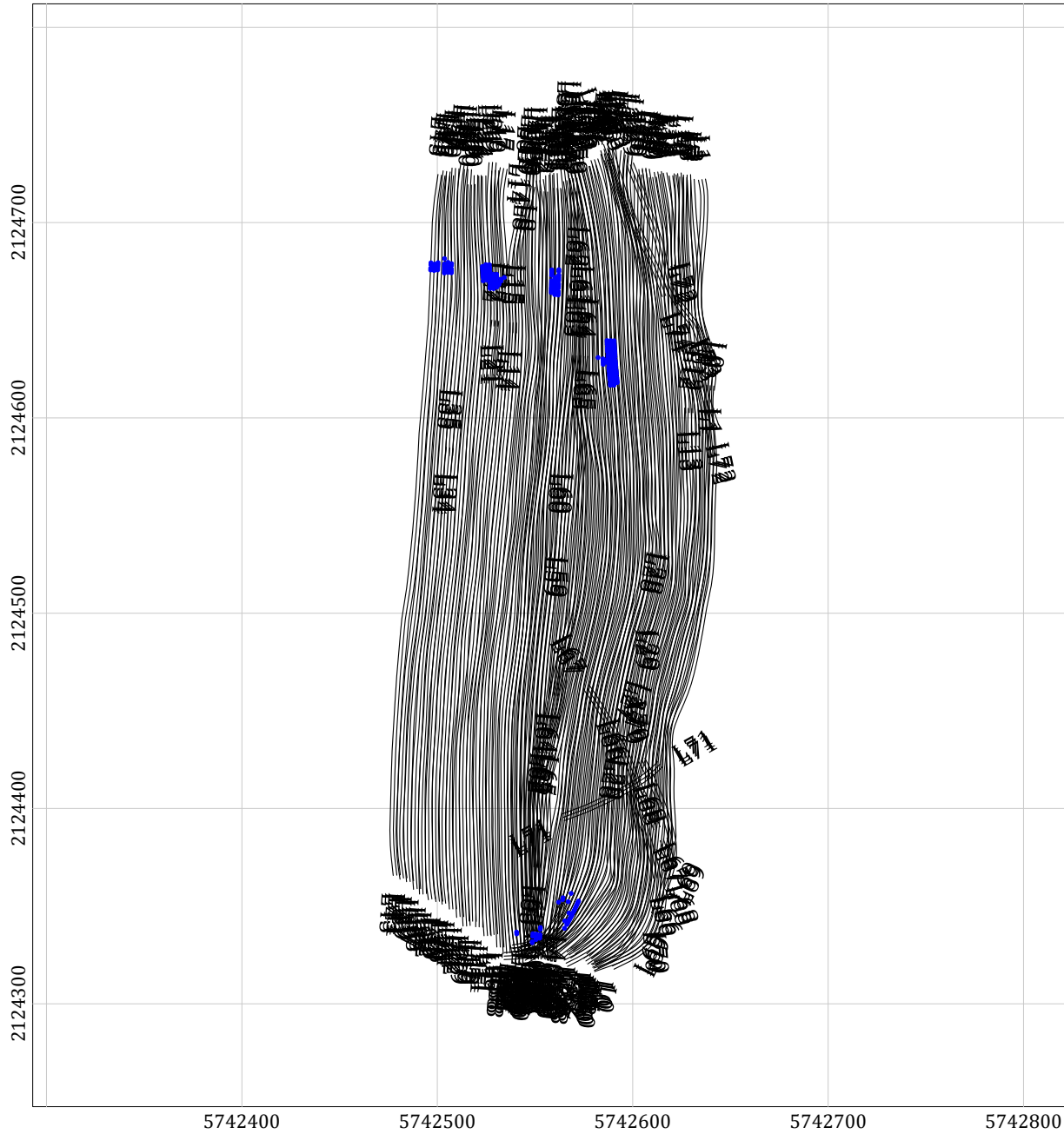
## Sample Separation



### LEGEND

-  Line path
  -  Flag Separation
- Data exceeding max. data spacing: 0.1%





Client:	
Project:	
Contractor:	
Created by:	Verified by:
Date:	File: 012510-1TA_DATASEP
Page number:	Approved:



# MAP

## Sample Separation

### LEGEND

-  Line path
  -  Flag\_Separation
- Data exceeding max. data spacing: 1.2%

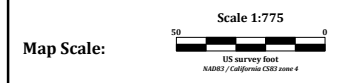

Client:	
Project:	
Contractor:	
Created by:	Verified by:
Date:	File: 012510-2TA_DATASEP
Page number:	Approved:

# MAP

## Sample Separation

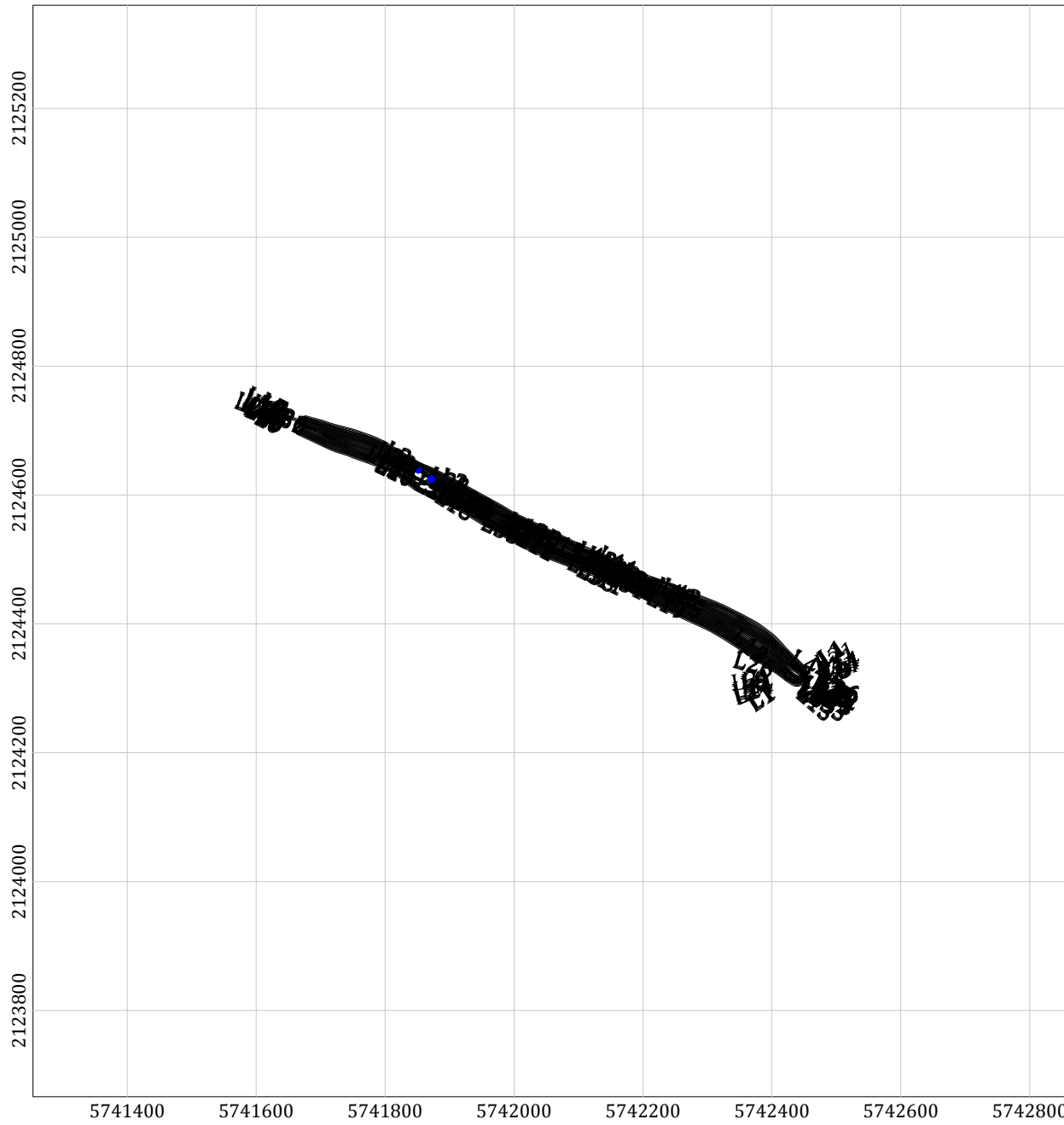

### LEGEND

- Line path
- Flag\_Separation

Data exceeding max. data spacing: 0.0%

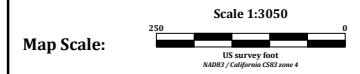

Client:	
Project:	
Contractor:	
Created by:	Verified by:
Date:	File: 012710-1TA_DATASEP
Page number:	Approved:



# MAP

## Sample Separation

### LEGEND

-  Line path
  -  Flag\_Separation
- Data exceeding max. data spacing: 0.4%

Map Scale:  Scale 1:625  
US survey foot  
 NAD83 / California CSRS zone 4

 N  
 Grid North: 0°0'0"  
 Mag North: 0°0'0"

Client:	
Project:	
Contractor:	
Created by:	Verified by:
Date:	File: 012710-2TA_DATASEP
Page number:	Approved:



# MAP

## Sample Separation

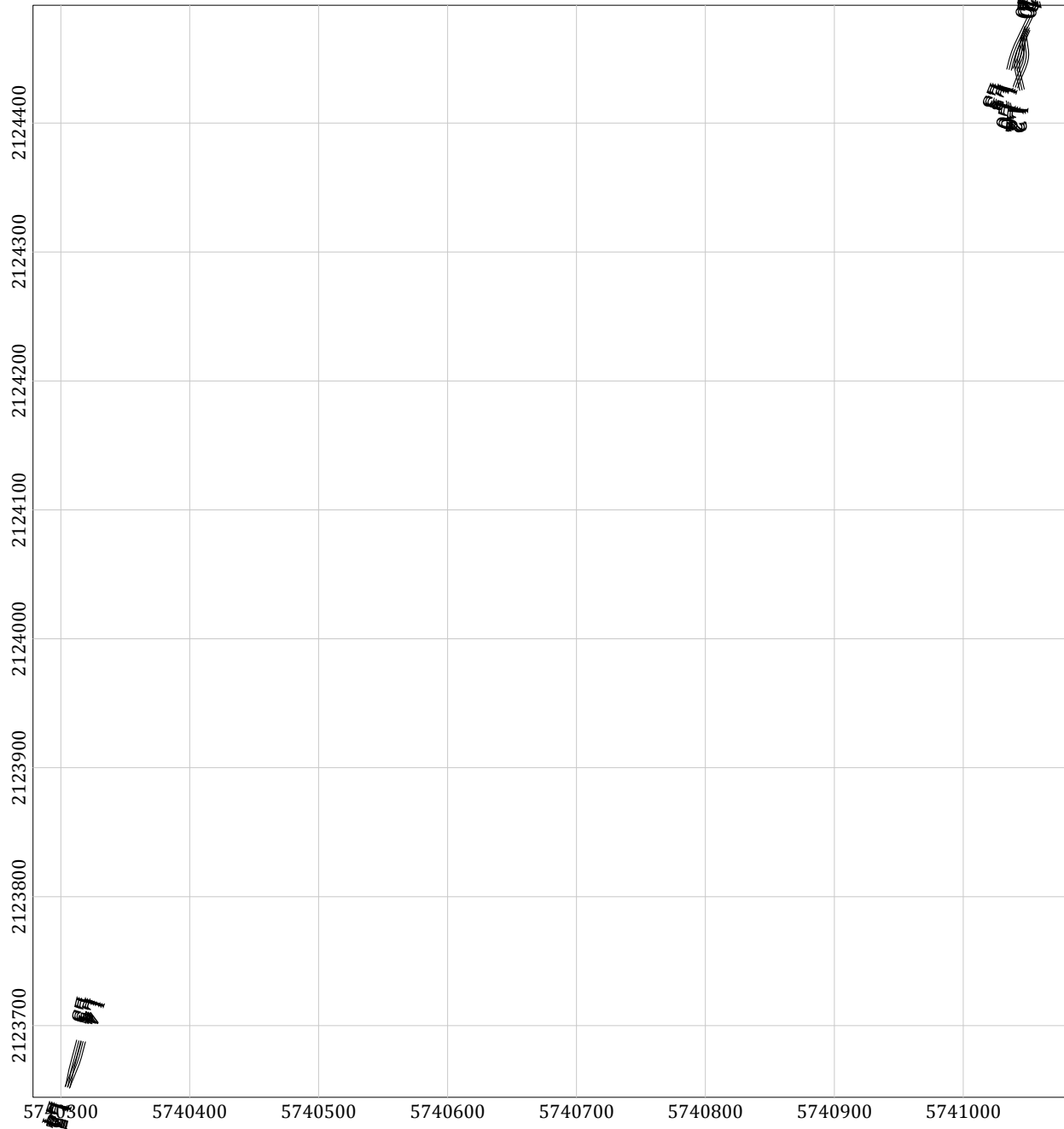

### LEGEND

- Line path
- Flag\_Separation

Data exceeding max. data spacing: 0.0%

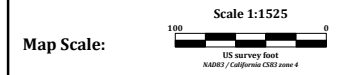



Client:	
Project:	
Contractor:	
Created by:	Verified by:
Date:	File: 012810-2TA_DATASEP
Page number:	Approved:

# MAP

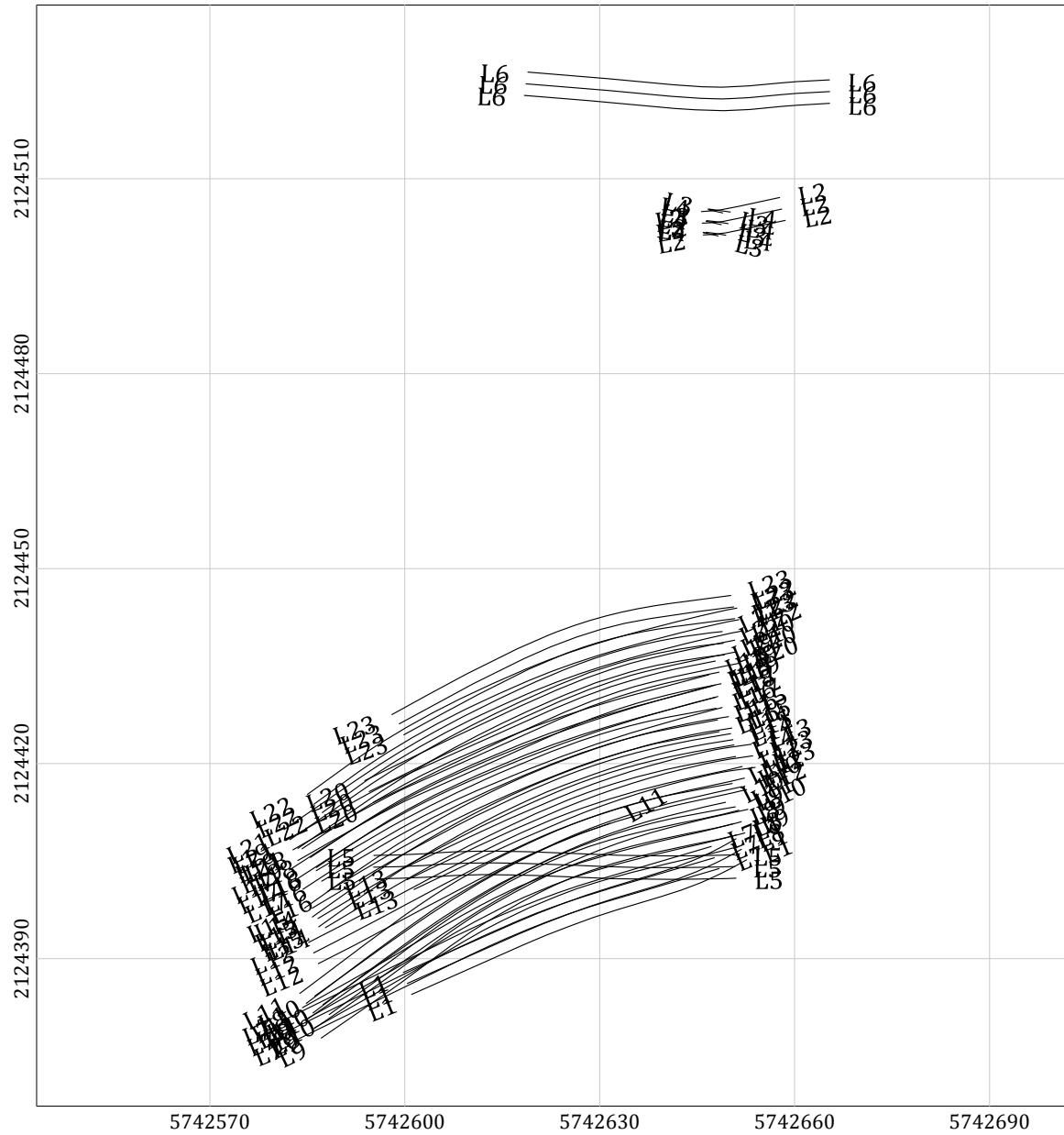
## Sample Separation



### LEGEND

-  Line path
  -  Flag Separation
- Data exceeding max. data spacing: 0.0%





Client:	
Project:	
Contractor:	
Created by:	Verified by:
Date:	File: 012910-2TA_DATASEP
Page number:	Approved:

# MAP

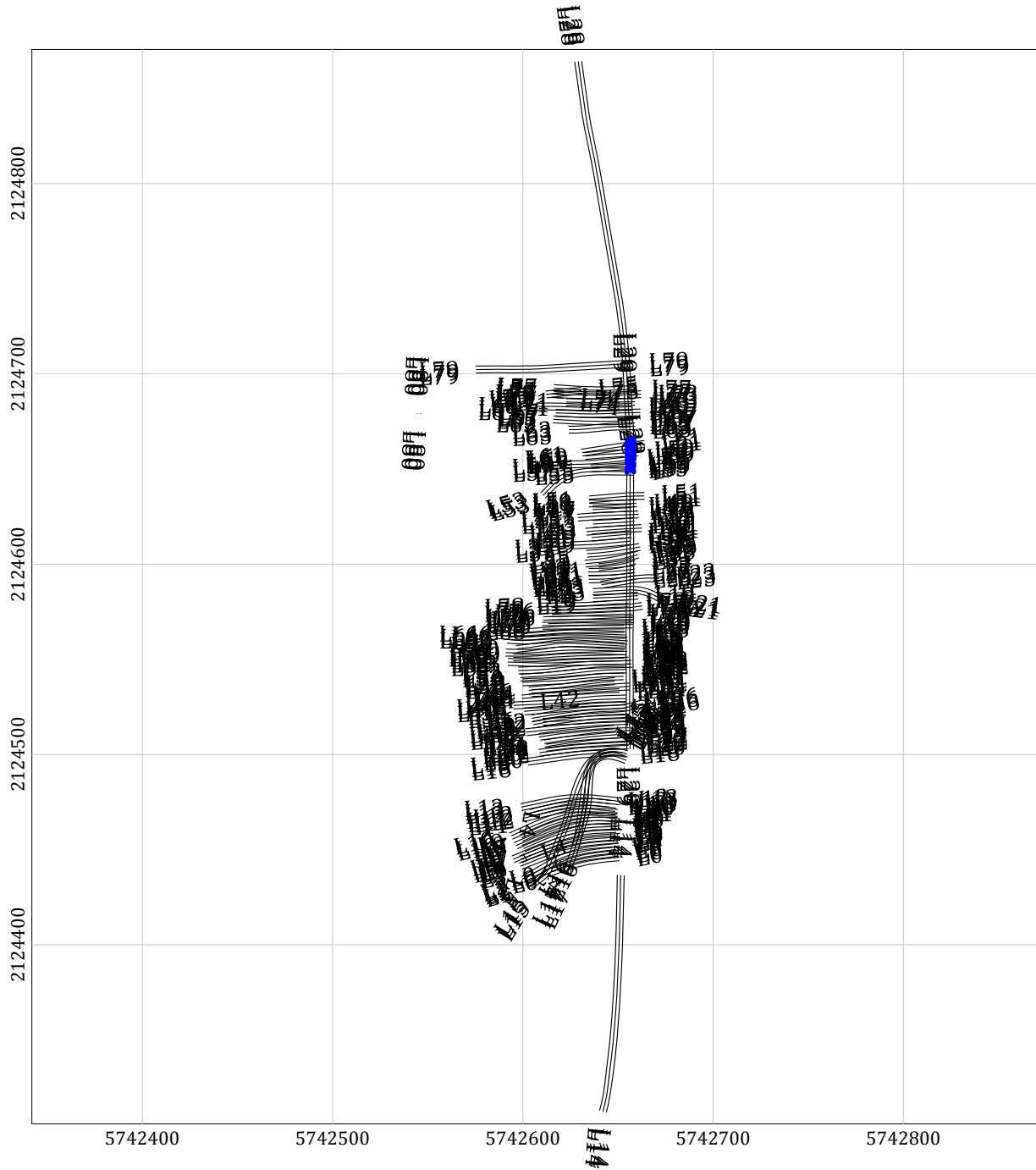
## Sample Separation



### LEGEND

-  Line path
  -  Flag\_Separation
- Data exceeding max. data spacing: 0.1%



Client:	
Project:	
Contractor:	
Created by:	Verified by:
Date:	File: 012910-3TA_DATASEP
Page number:	Approved:

# MAP

## Sample Separation

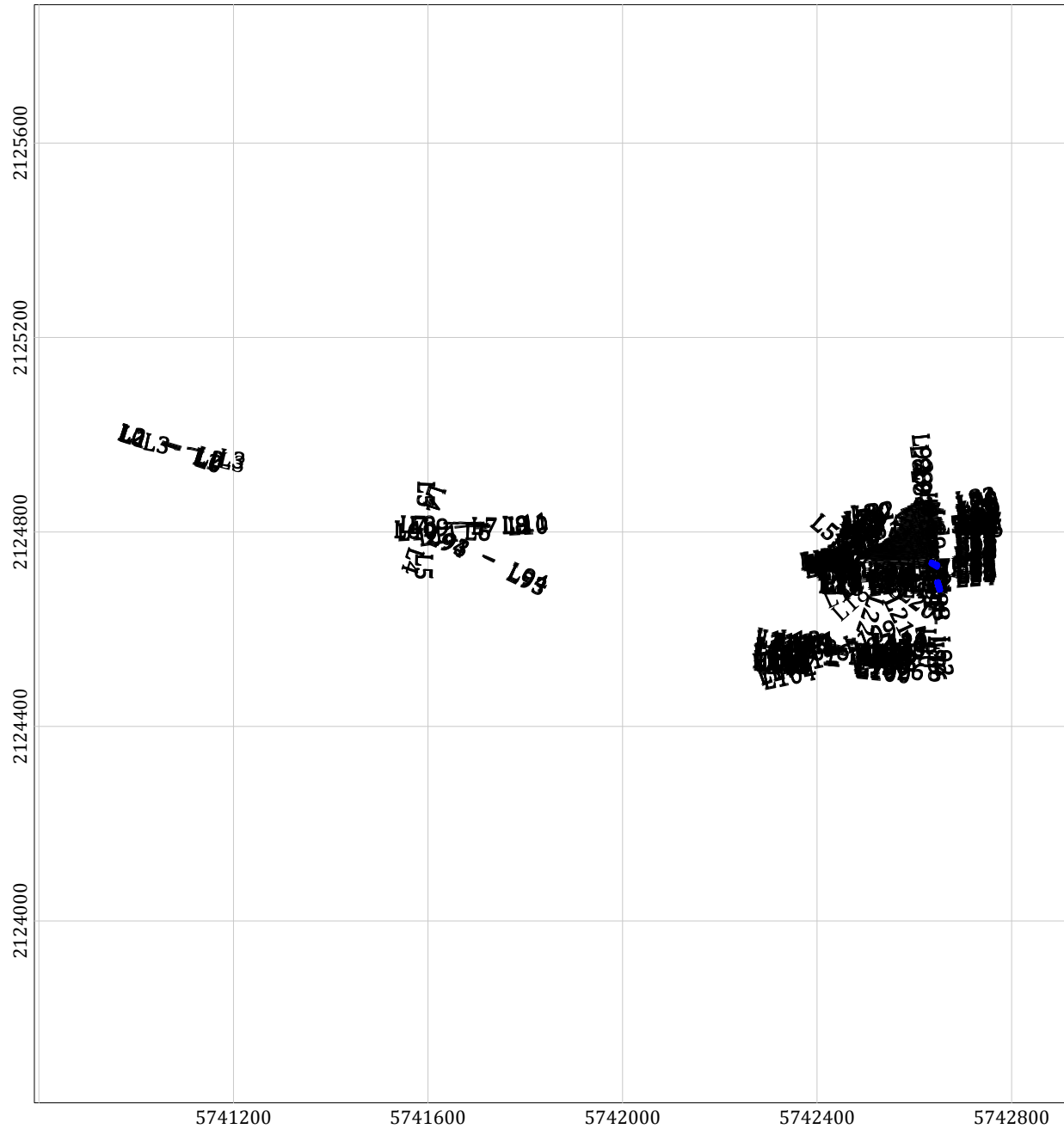

### LEGEND

- Line path
  - Flag\_Separation
- Data exceeding max. data spacing: 0.2%



Client:	
Project:	
Contractor:	
Created by:	Verified by:
Date:	File: 020210-1TA_DATASEP
Page number:	Approved:

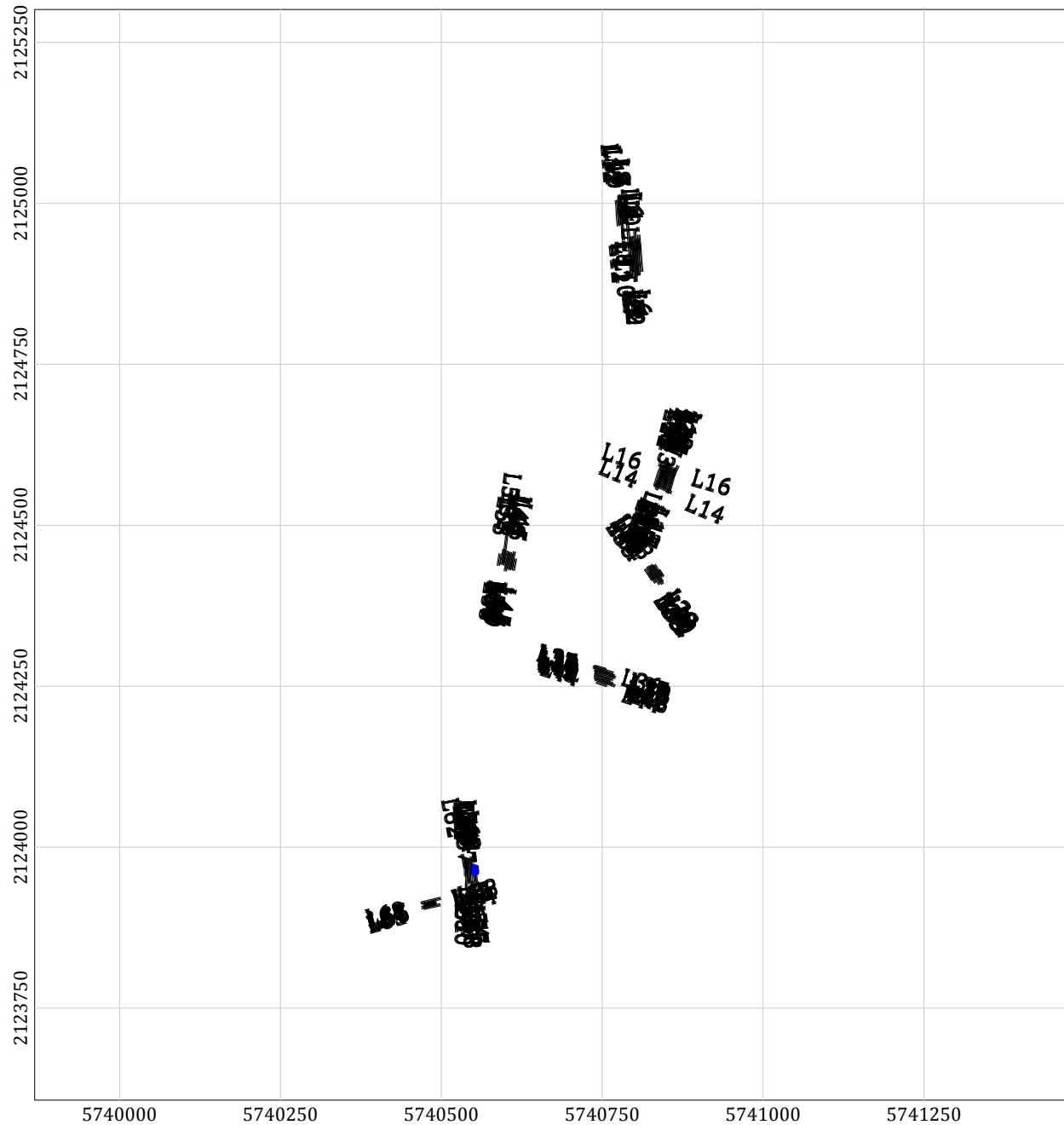

# MAP

## Sample Separation

### LEGEND

- Line path
- ..... Flag Separation

Data exceeding max. data spacing: 0.2%

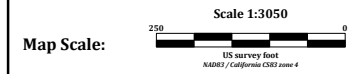

Client:	
Project:	
Contractor:	
Created by:	Verified by:
Date:	File: 020210-2TA_DATASEP
Page number:	Approved:

# MAP

## Sample Separation

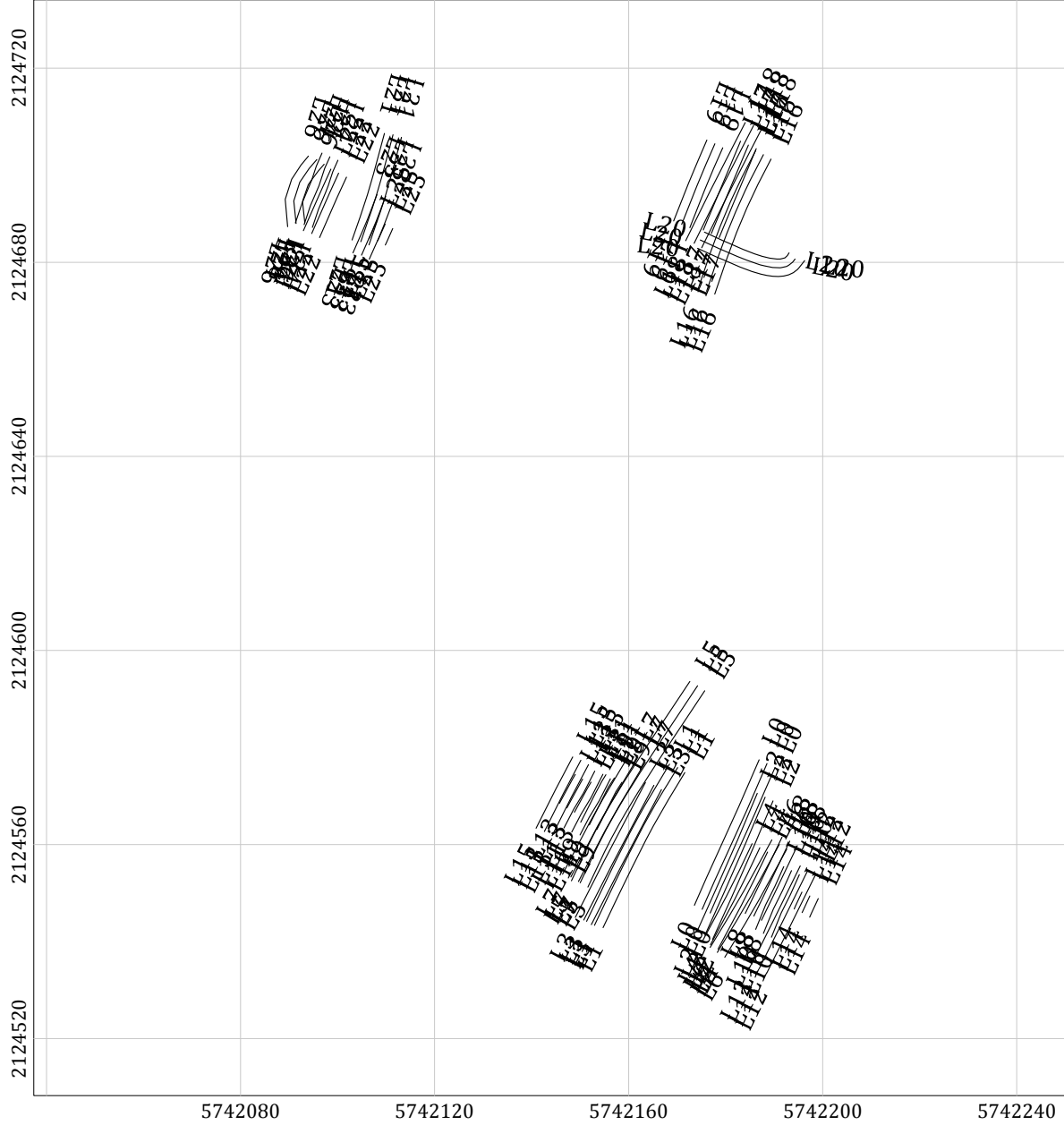

### LEGEND

-  Line path
  -  Flag\_Separation
- Data exceeding max. data spacing: 0.0%

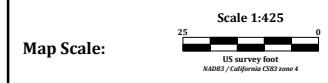

Client:	
Project:	
Contractor:	
Created by:	Verified by:
Date:	File: 020210-3TA_DATASEP
Page number:	Approved:

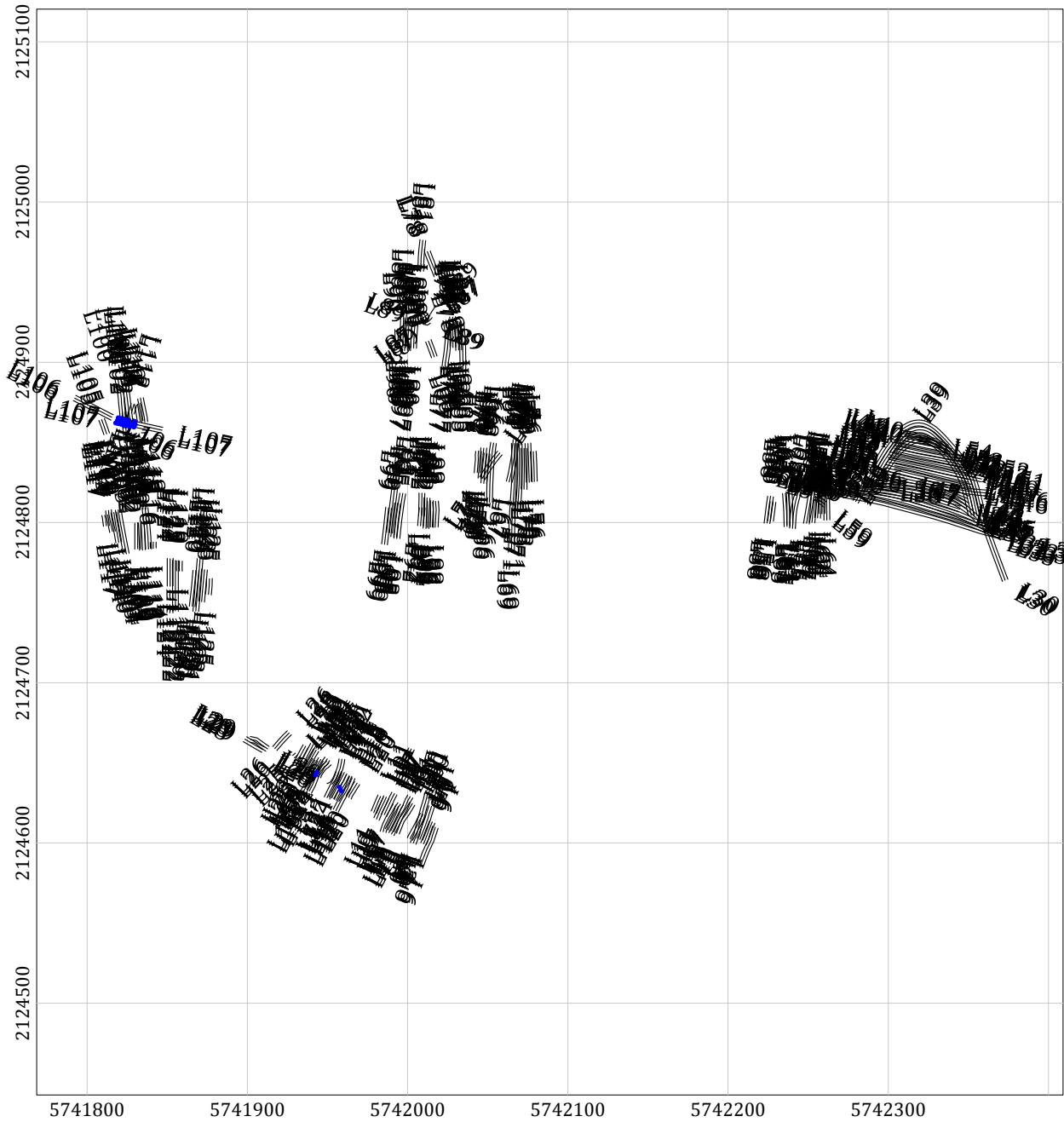

# MAP

## Sample Separation

### LEGEND

- Line path
  - Flag\_Separation
- Data exceeding max. data spacing: 0.1%



Client:	
Project:	
Contractor:	
Created by:	Verified by:
Date:	File: 020410-1TA_DATASEP
Page number:	Approved:



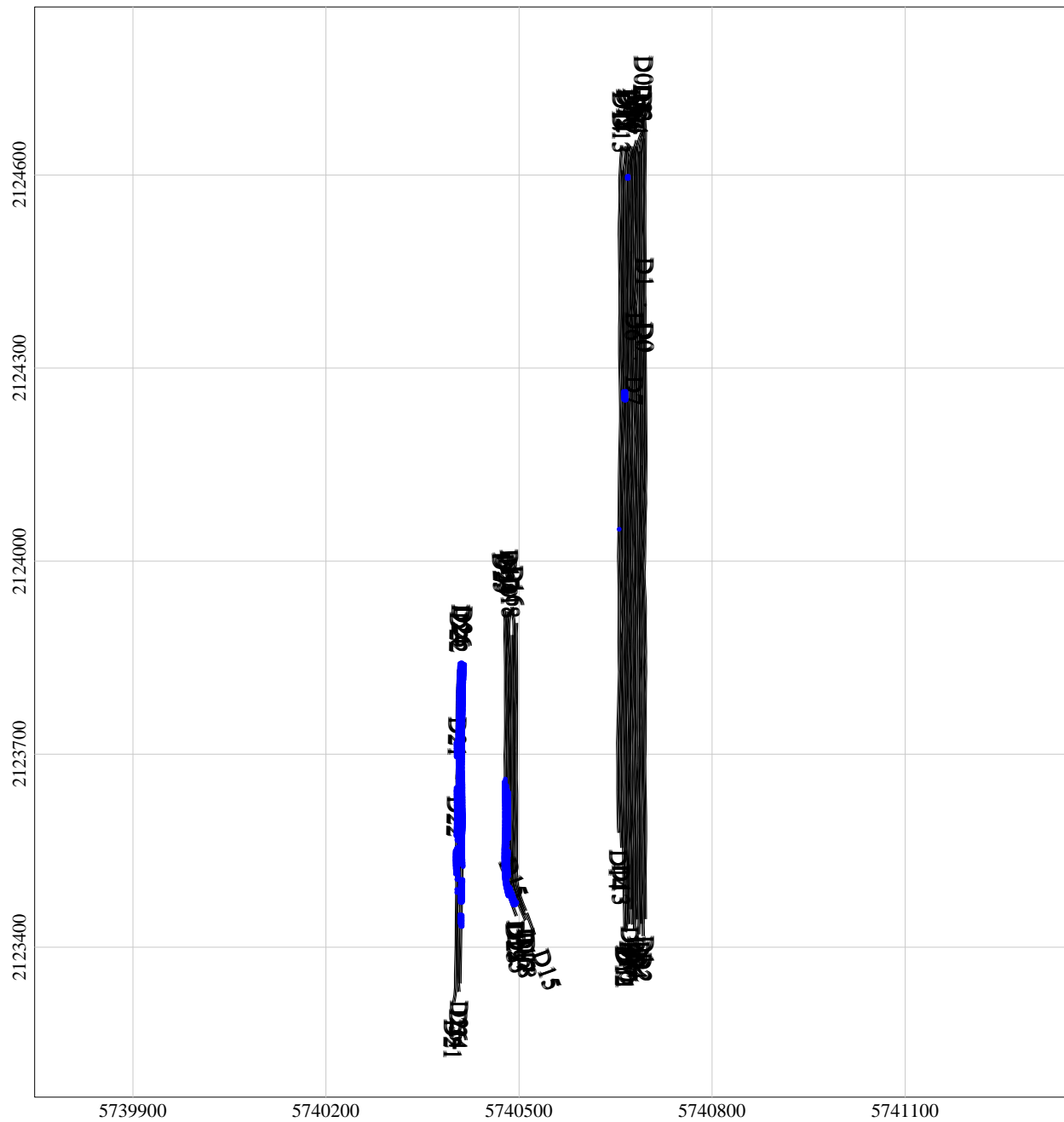



# MAP

## Sample Separation

### LEGEND

-  Line path
  -  Flag\_Separation
- Data exceeding max. data spacing: 1.9%

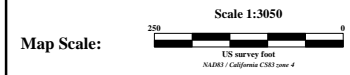

Client:	
Project:	
Contractor:	
Created by:	Verified by:
Date:	File: 020510-1TA_DATASEP
Page number:	Approved:

# MAP

## Sample Separation

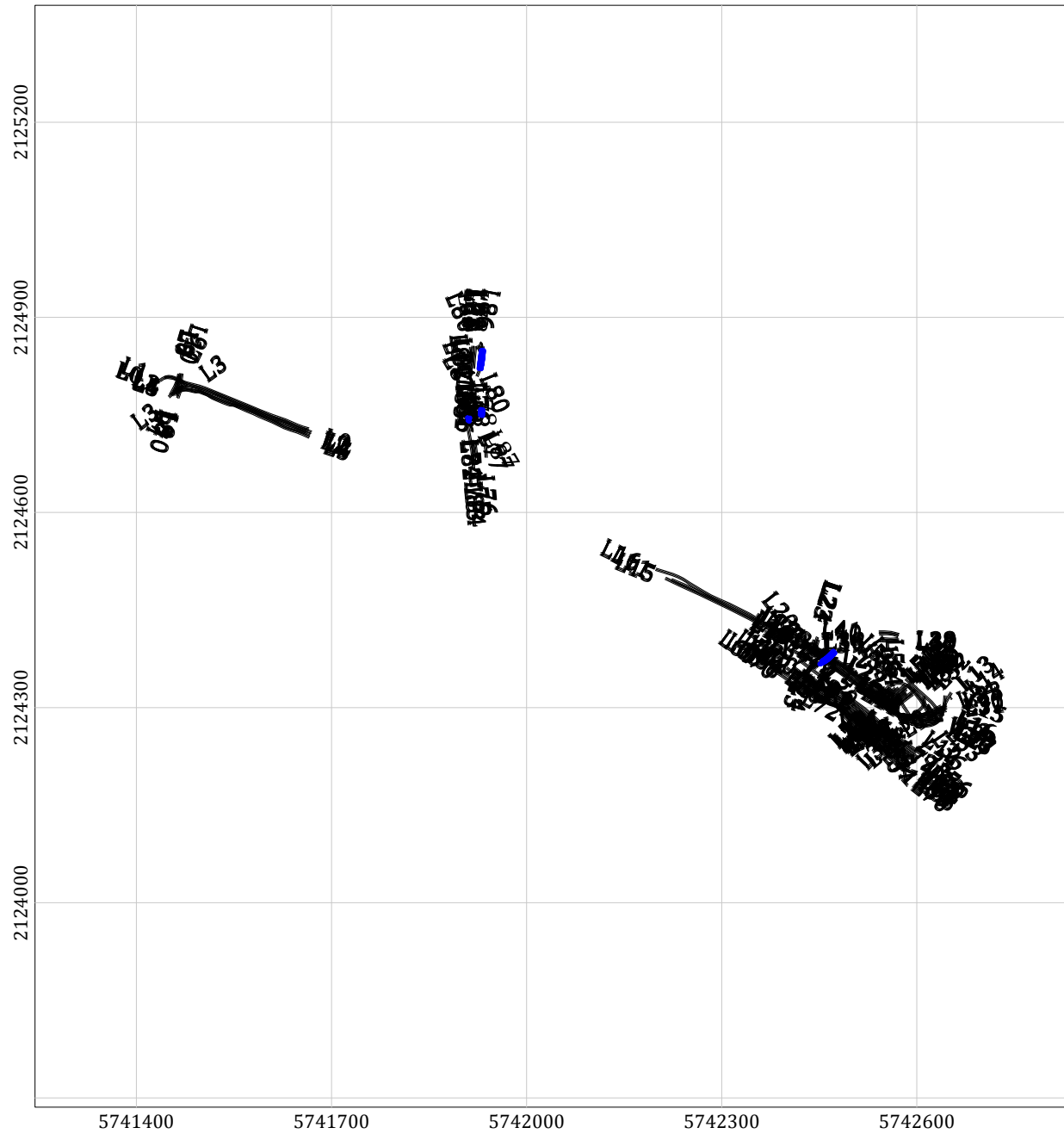

### LEGEND

- Line path
  - Flag\_Separation
- Data exceeding max. data spacing: 0.3%

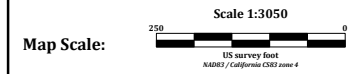

Client:	
Project:	
Contractor:	
Created by:	Verified by:
Date:	File: 021010-1TA_DATASEP
Page number:	Approved:

# MAP

## Sample Separation

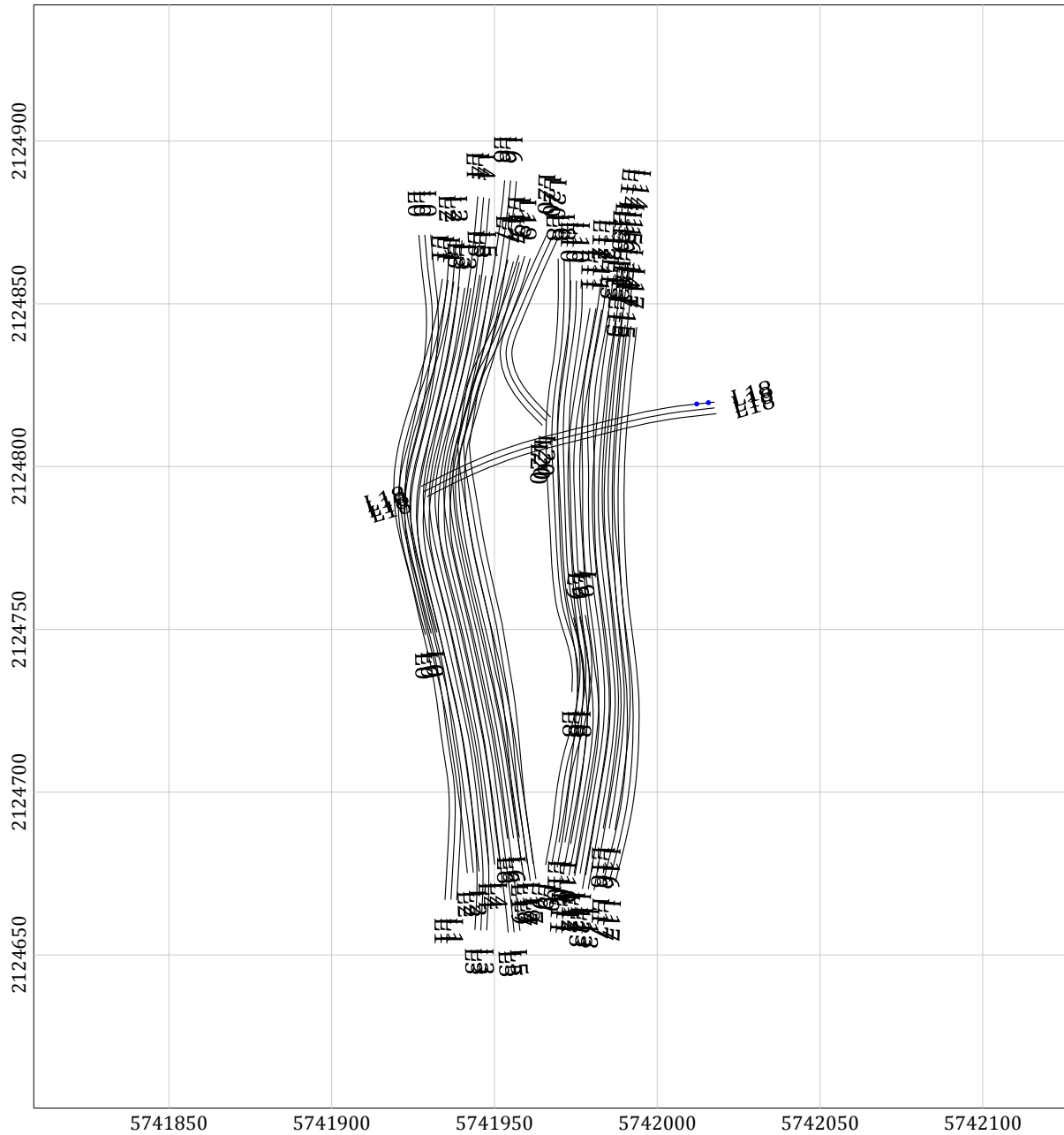

### LEGEND

- Line path
  - ..... Flag\_Separation
- Data exceeding max. data spacing: 0.0%





Client:	
Project:	
Contractor:	
Created by:	Verified by:
Date:	File: 021010-2TA_DATASEP
Page number:	Approved:

# MAP

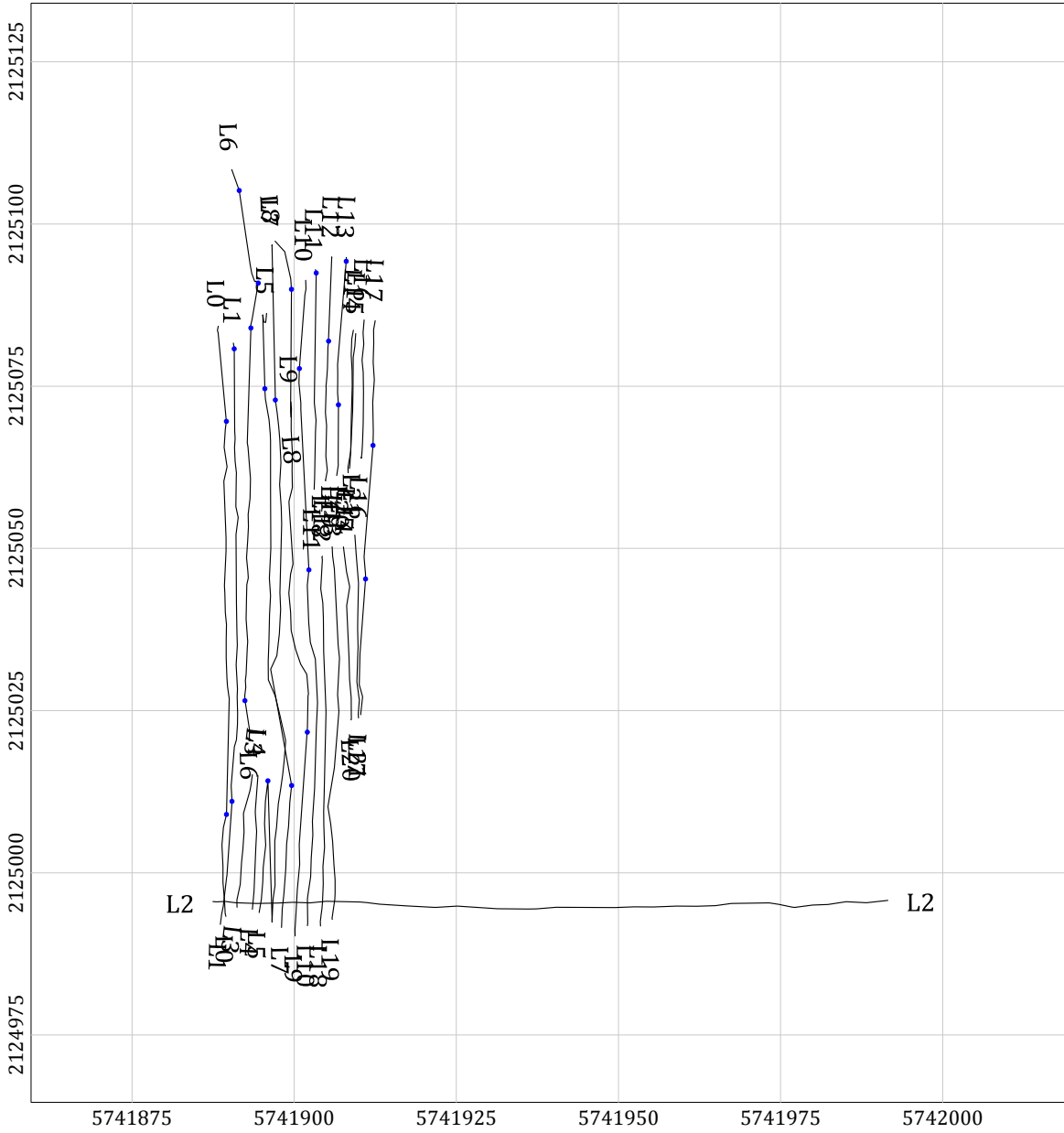
## Sample Separation



### LEGEND

-  Line path
  -  Flag\_Separation
- Data exceeding max. data spacing: 0.4%

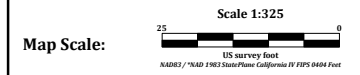

Client:	
Project:	
Contractor:	
Created by:	Verified by:
Date:	File: 021110-1SU_DATASEP
Page number:	Approved:

# MAP

## Sample Separation

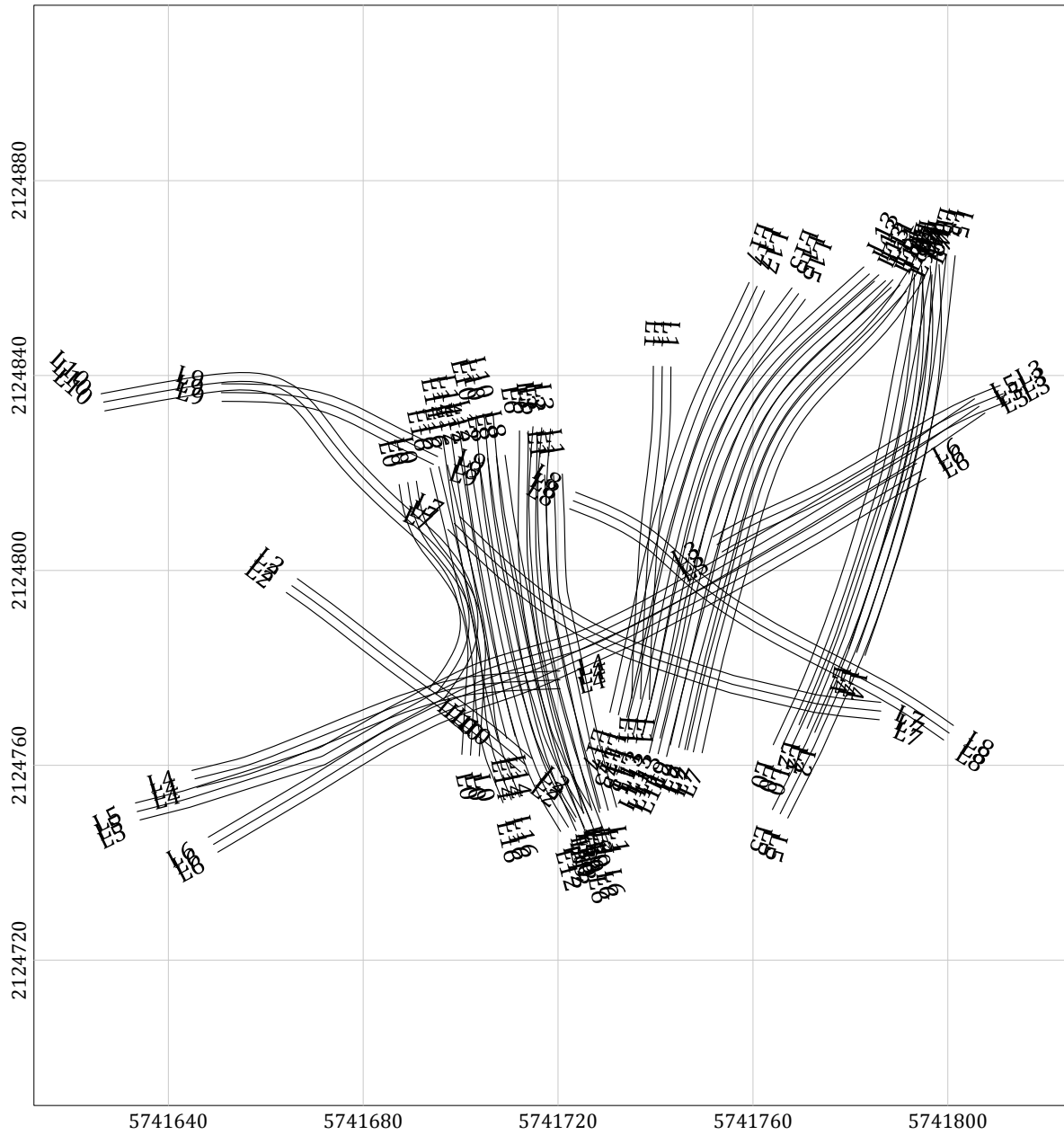

### LEGEND

- Line path
  - Flag\_Separation
- Data exceeding max. data spacing: 0.0%





Client:	
Project:	
Contractor:	
Created by:	Verified by:
Date:	File: 021110-1TA_DATASEP
Page number:	Approved:

# MAP

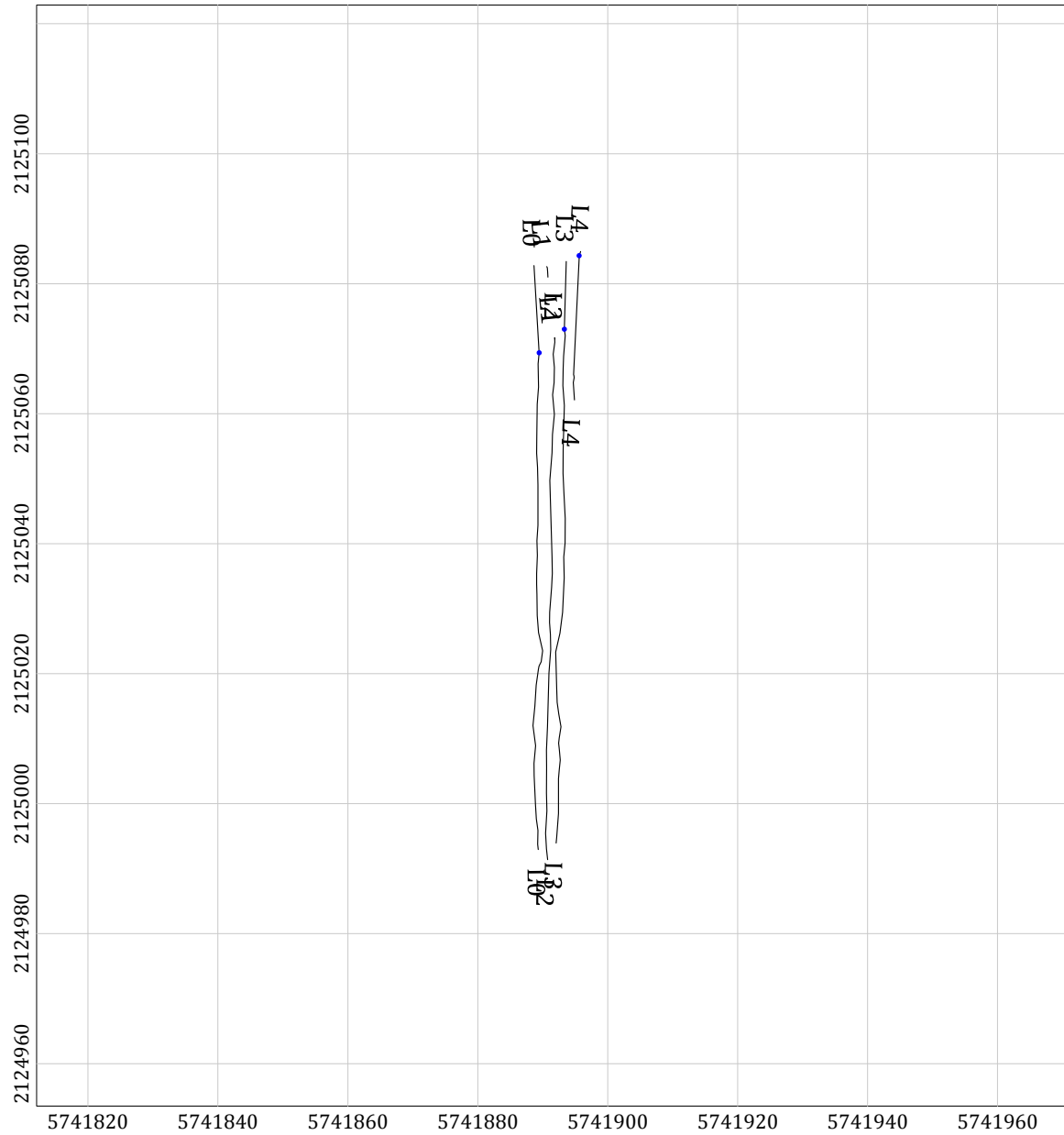
## Sample Separation



### LEGEND

-  Line path
  -  Flag Separation
- Data exceeding max. data spacing: 0.2%



Client:	
Project:	
Contractor:	
Created by:	Verified by:
Date:	File: 021110-2SU_DATASEP
Page number:	Approved:

# MAP

## Sample Separation

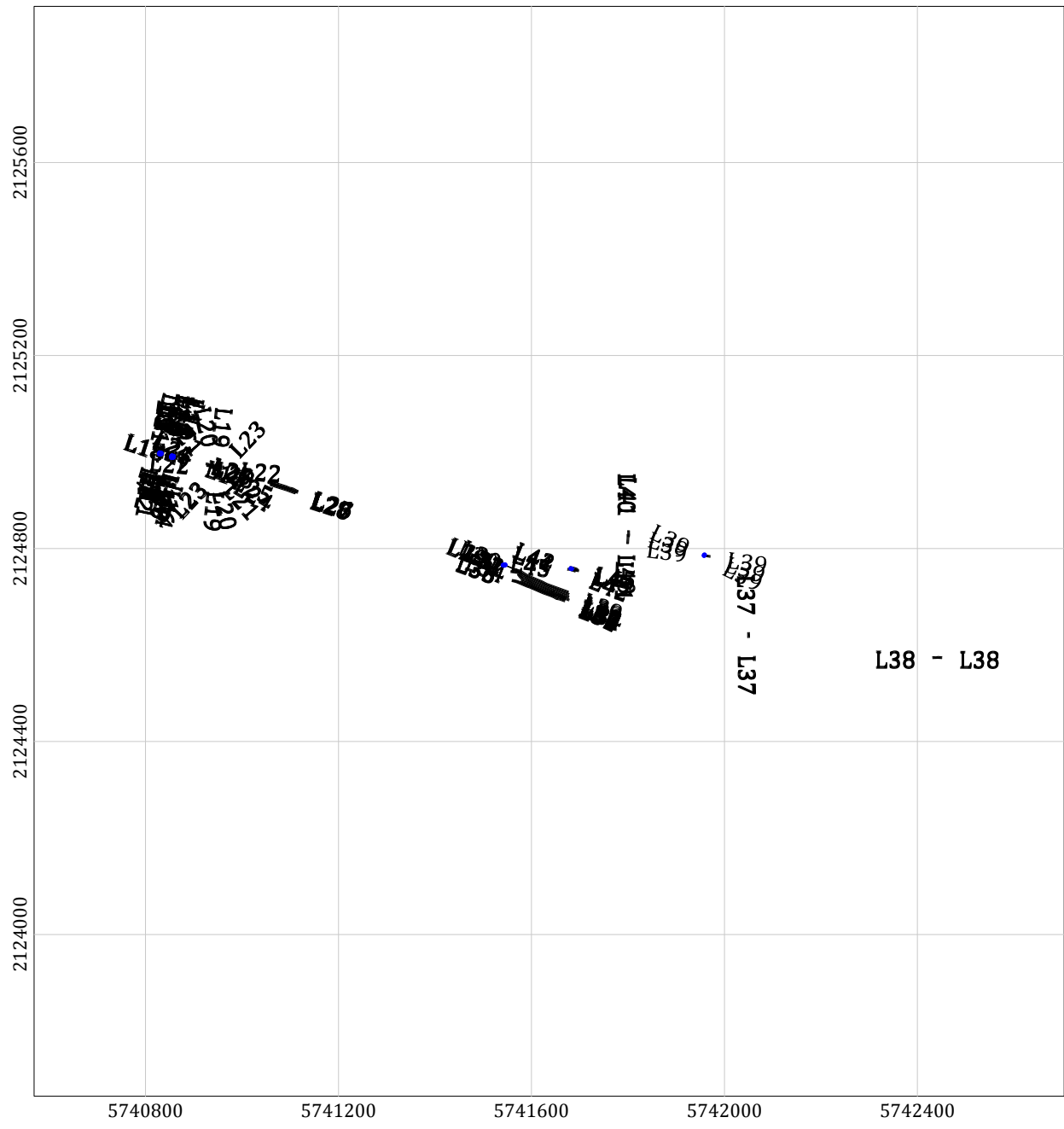

### LEGEND

- Line path
  - ..... Flag Separation
- Data exceeding max. data spacing: 0.2%

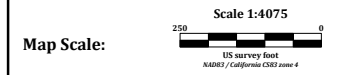

Client:	
Project:	
Contractor:	
Created by:	Verified by:
Date:	File: 021110-2TA_DATASEP
Page number:	Approved:

# MAP

## Sample Separation

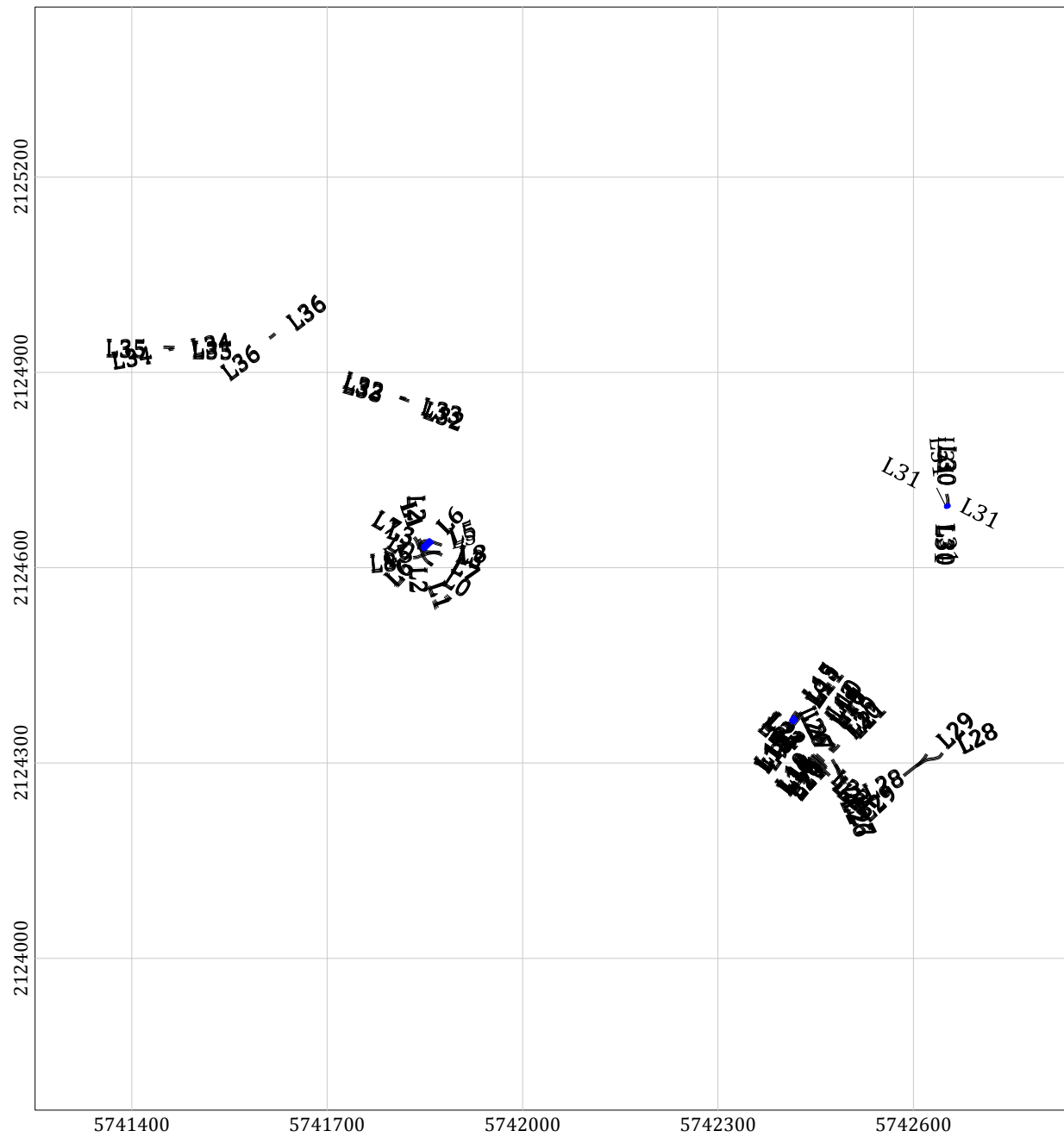

### LEGEND

-  Line path
  -  Flag\_Separation
- Data exceeding max. data spacing: 0.7%

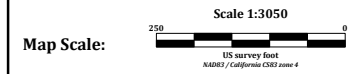

Client:	
Project:	
Contractor:	
Created by:	Verified by:
Date:	File: 021210-1TA_DATASEP
Page number:	Approved:



# MAP

## Sample Separation

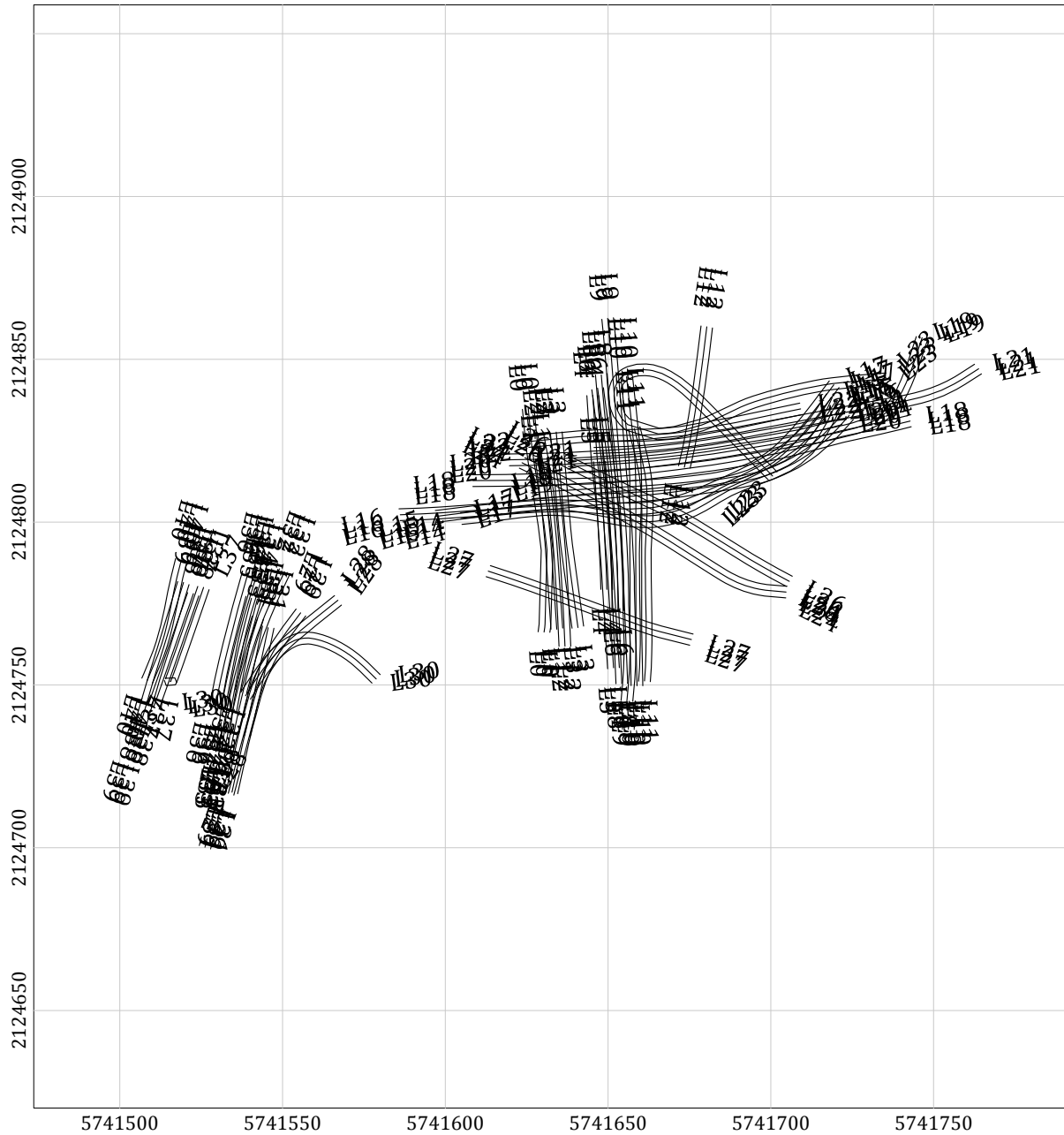

### LEGEND

- Line path
- ..... Flag\_Separation

Data exceeding max. data spacing: 0.0%

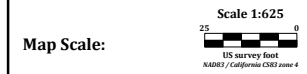



Client:	
Project:	
Contractor:	
Created by:	Verified by:
Date:	File: 021210-3TA_DATASEP
Page number:	Approved:

# MAP

## Sample Separation

### LEGEND

-  Line path
  -  Flag Separation
- Data exceeding max. data spacing: 0.1%

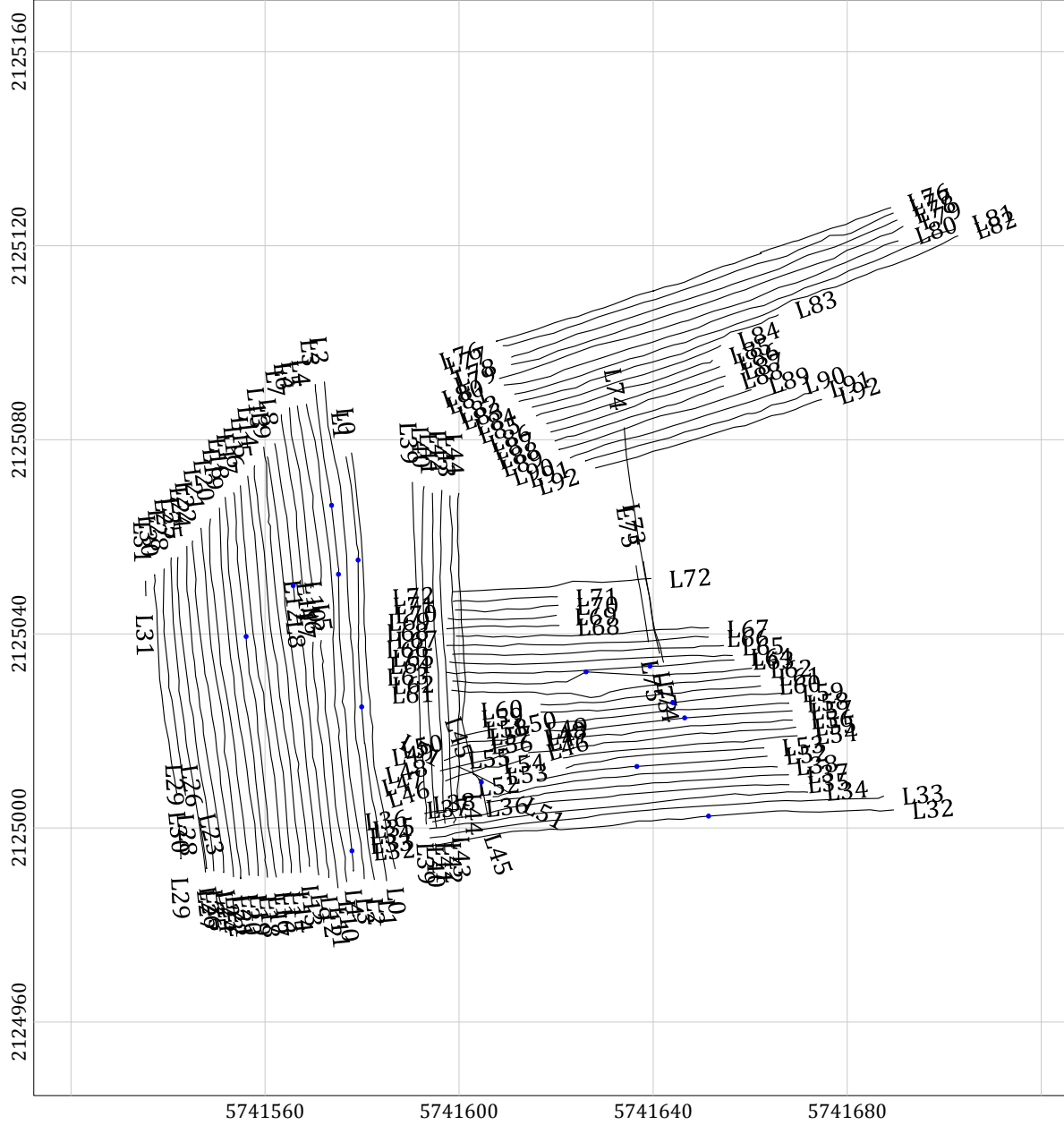
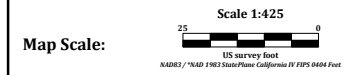

Client:	
Project:	
Contractor:	
Created by:	Verified by:
Date:	File: 021510-1SU_DATASEP
Page number:	Approved:

# MAP

## Sample Separation

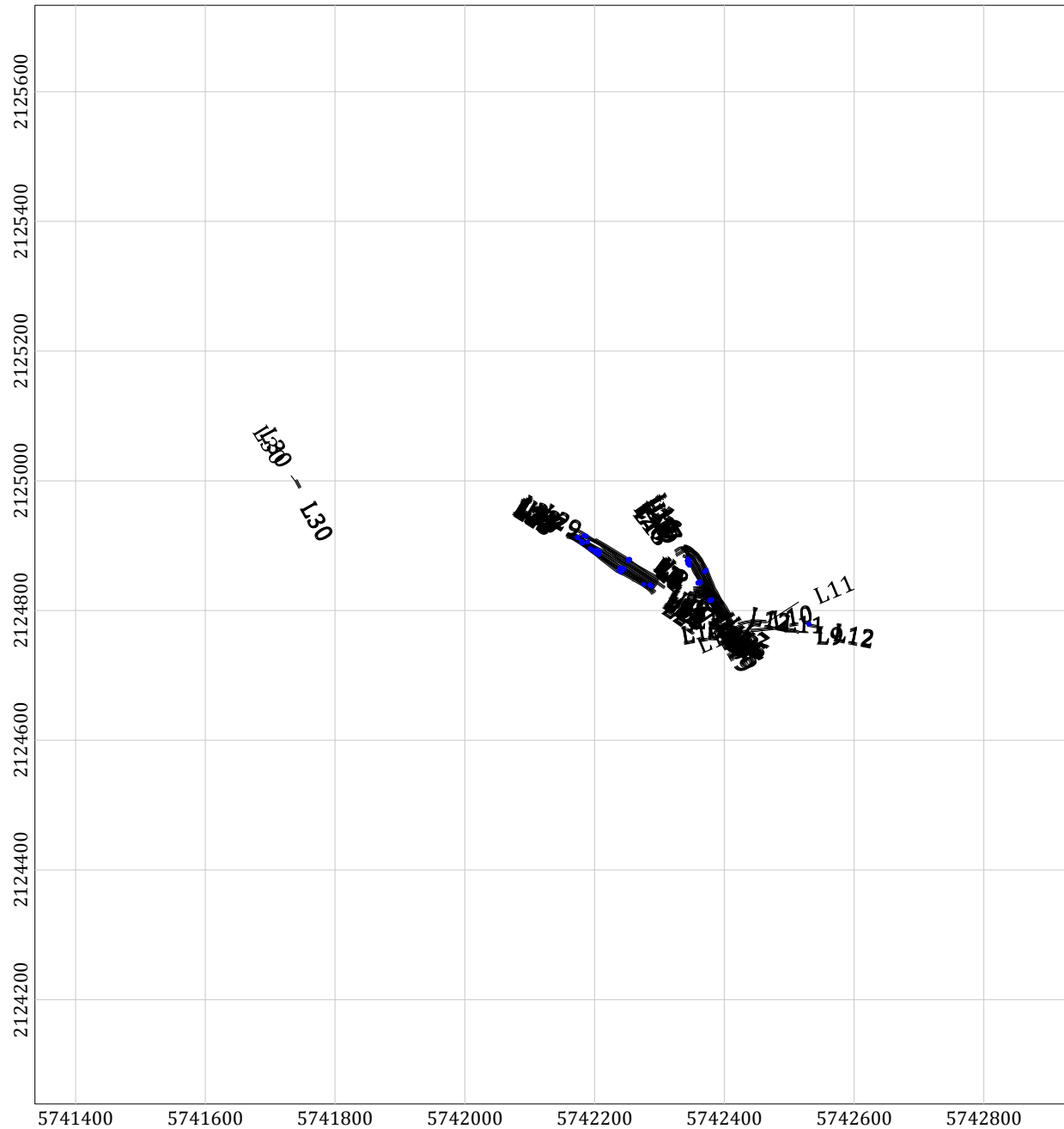

### LEGEND

- Line path
  - ..... Flag\_Separation
- Data exceeding max. data spacing: 0.4%

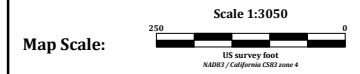

Client:	
Project:	
Contractor:	
Created by:	Verified by:
Date:	File: 021510-1TA_DATASEP
Page number:	Approved:

# MAP

## Sample Separation

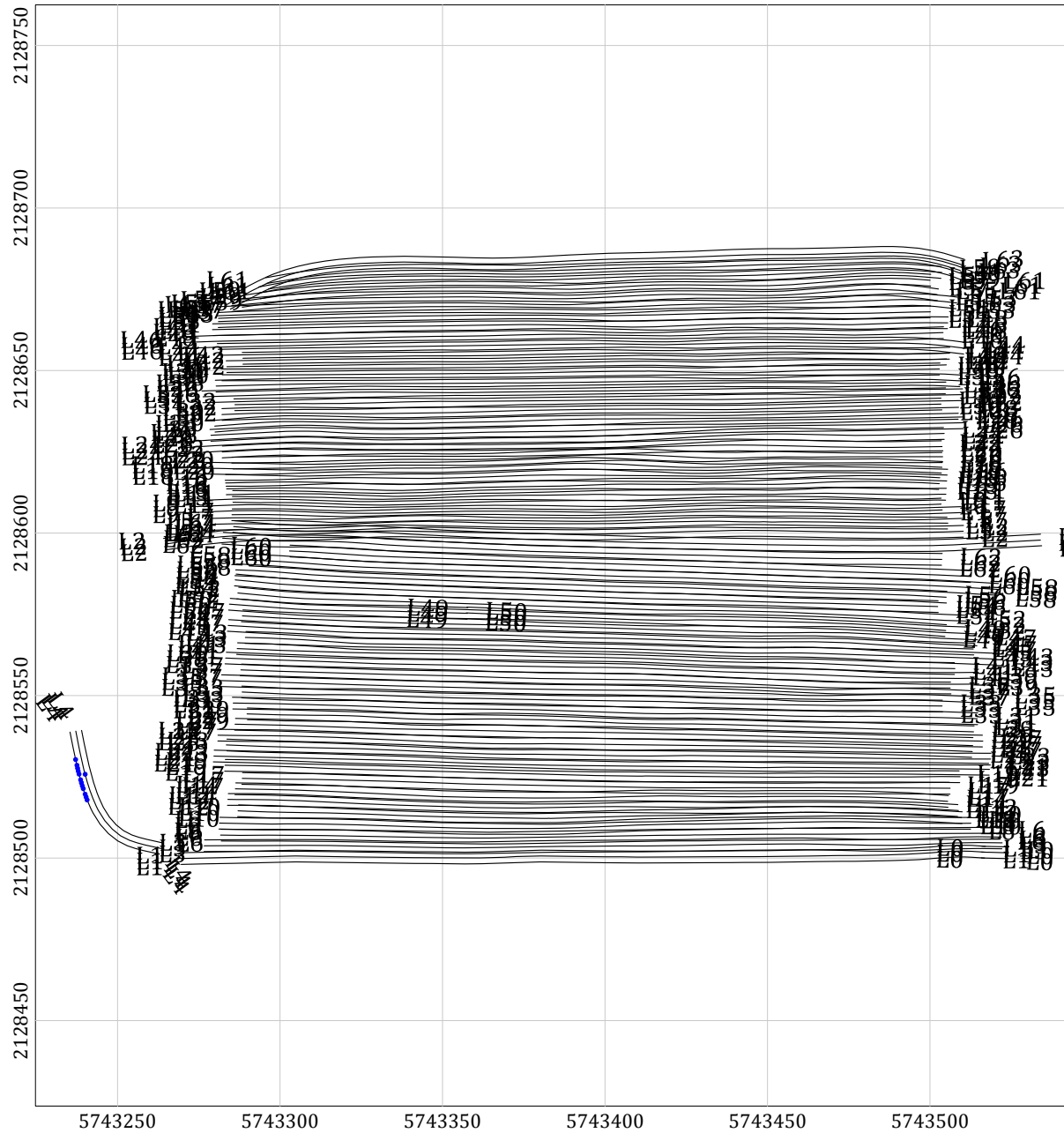

### LEGEND

-  Line path
  -  Flag Separation
- Data exceeding max. data spacing: 0.0%



Client:

Project:

Contractor:

Created by:

Verified by:

Date:

File: 021810-1TA\_DATASEP

Page number:

Approved:

# MAP

## Sample Separation

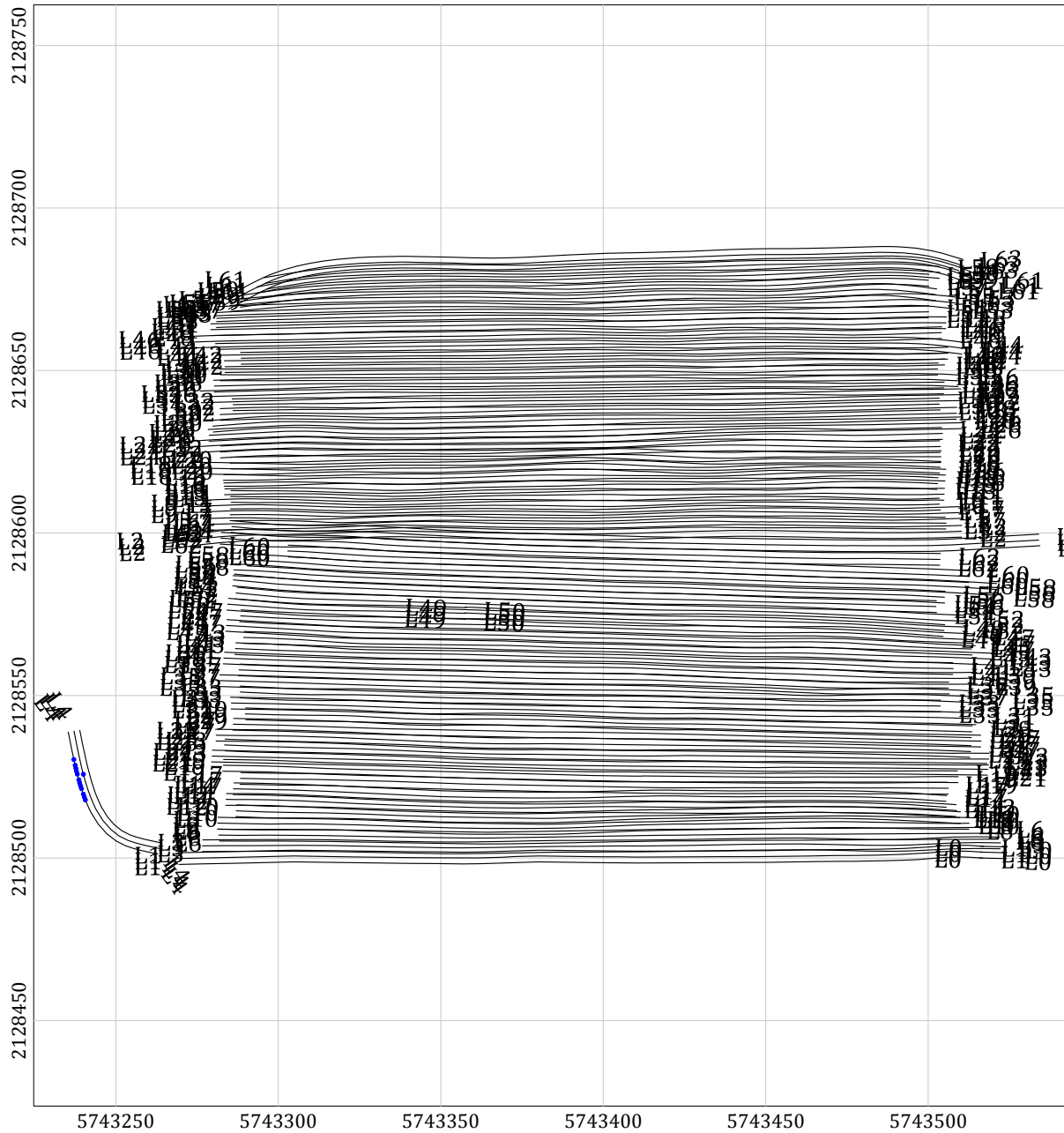

### LEGEND

- Line path
  - Flag Separation
- Data exceeding max. data spacing: 0.0%



Client:	
Project:	
Contractor:	
Created by:	Verified by:
Date:	File: 021810-1TA_DATASEP
Page number:	Approved:

# MAP

## Sample Separation

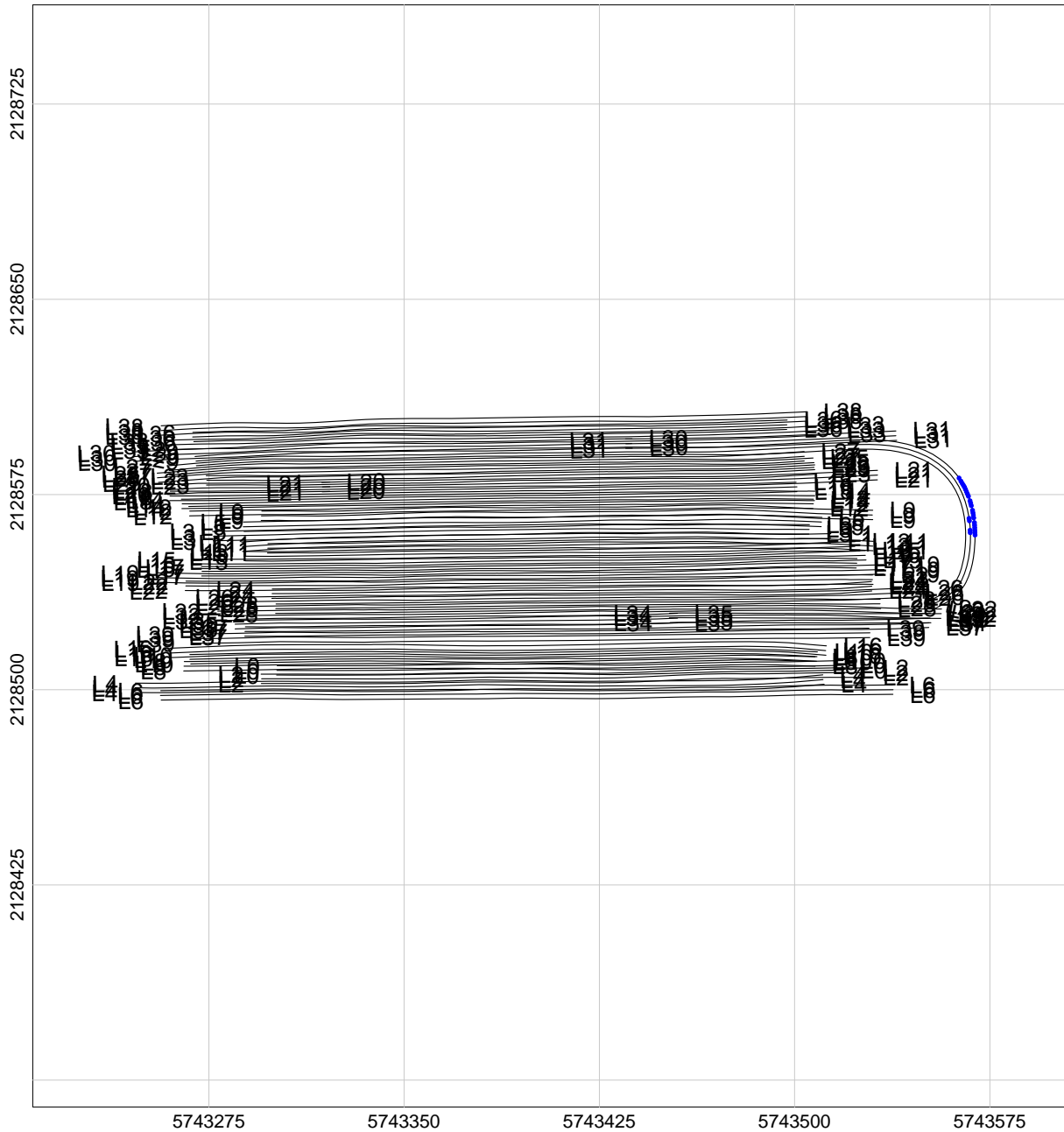

### LEGEND

- Line path
- ..... Flag\_Separation

Data exceeding max. data spacing: 0.0%

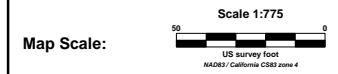

Client:	
Project:	
Contractor:	
Created by:	Verified by:
Date:	File: 030510-1TA_DATASEP
Page number:	Approved:

# MAP

## Sample Separation

### LEGEND

-  Line path
  -  Flag\_Separation
- Data exceeding max. data spacing: 0.0%

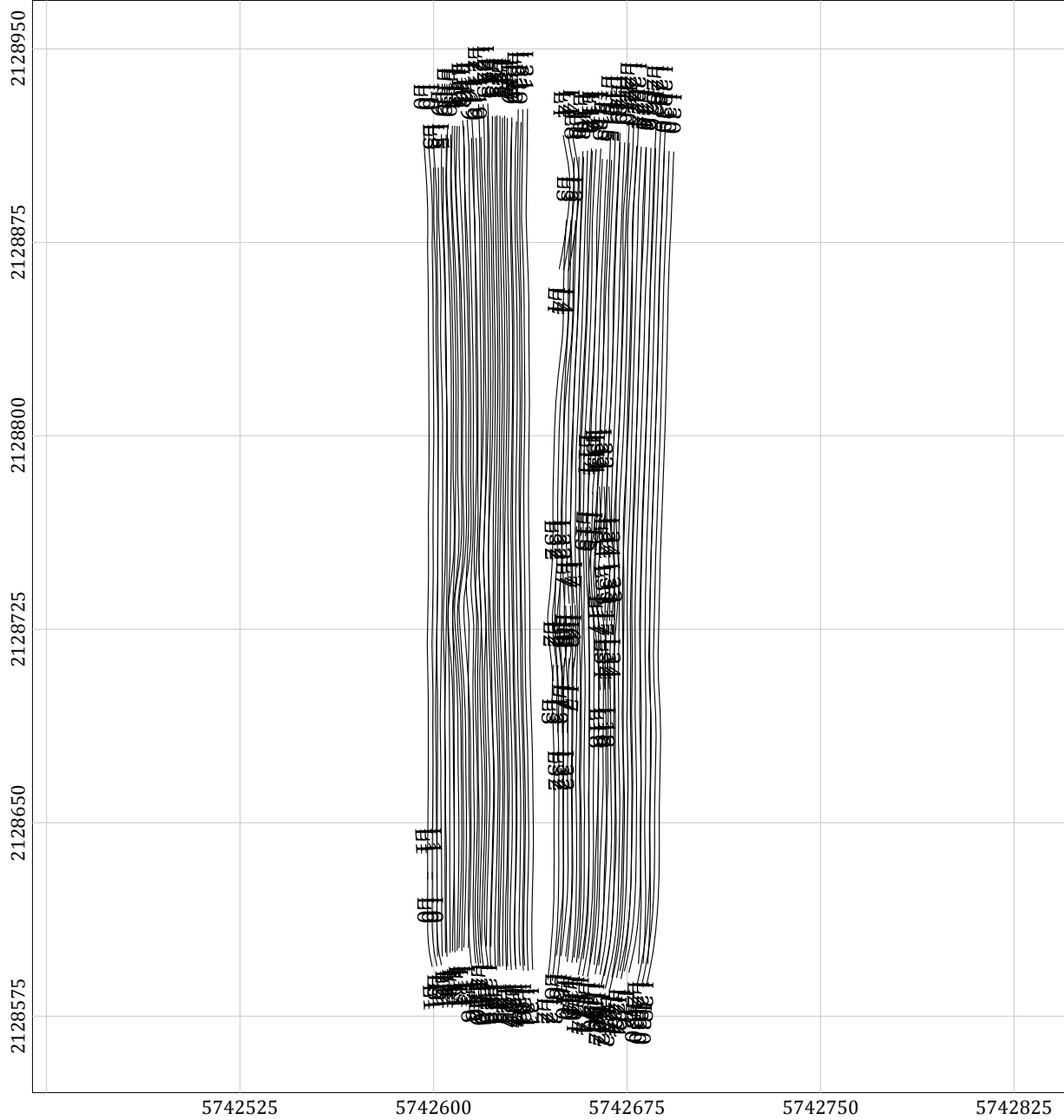
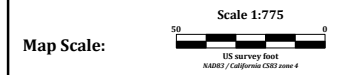



Client:	
Project:	
Contractor:	
Created by:	Verified by:
Date:	File: 031510-1TA_DATASEP
Page number:	Approved:

# MAP

## Sample Separation

### LEGEND

-  Line path
  -  Flag\_Separation
- Data exceeding max. data spacing: 0.0%





Client:	
Project:	
Contractor:	
Created by:	Verified by:
Date:	File: 031610-1TA_DATASEP
Page number:	Approved:



# MAP

## Sample Separation

### LEGEND

-  Line path
  -  Flag\_Separation
- Data exceeding max. data spacing: 0.2%

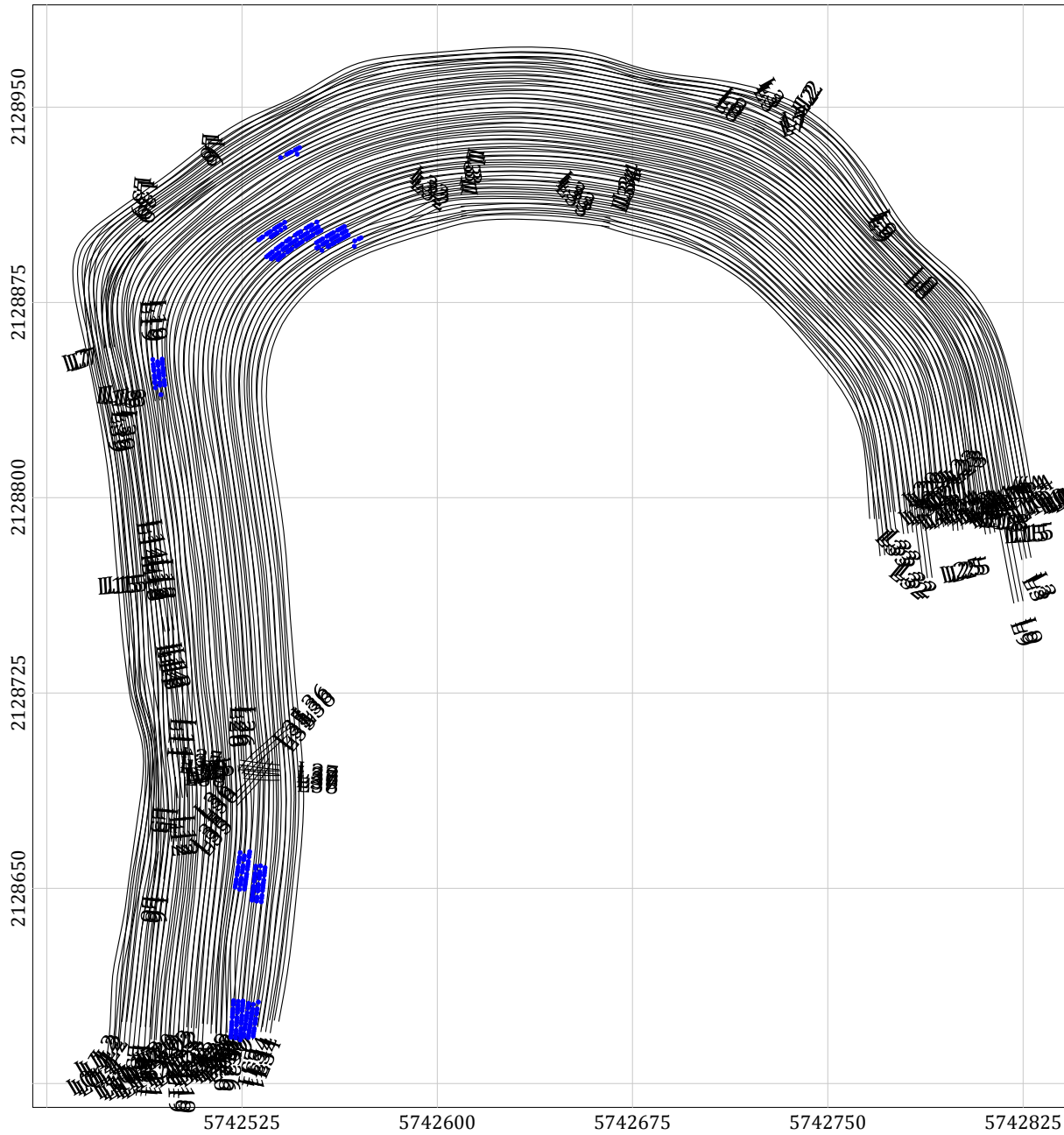
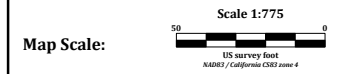



Client:	
Project:	
Contractor:	
Created by:	Verified by:
Date:	File: 031810-1TA_DATASEP
Page number:	Approved:

# MAP

## Sample Separation

### LEGEND

-  Line path
  -  Flag\_Separation
- Data exceeding max. data spacing: 0.9%



Map Scale:

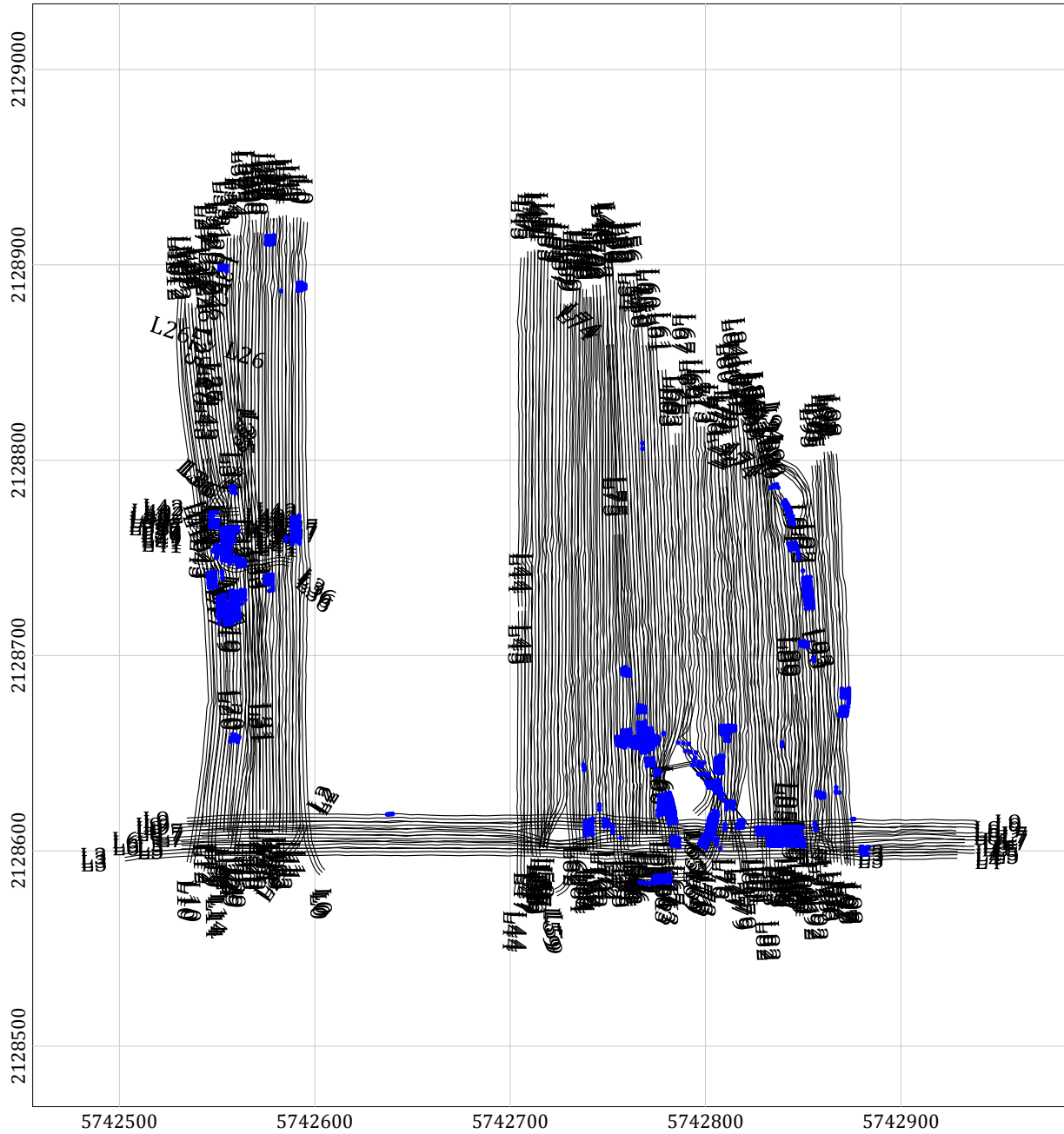

Client:	
Project:	
Contractor:	
Created by:	Verified by:
Date:	File: 031910-1TA_DATASEP
Page number:	Approved:

# MAP

## Sample Separation

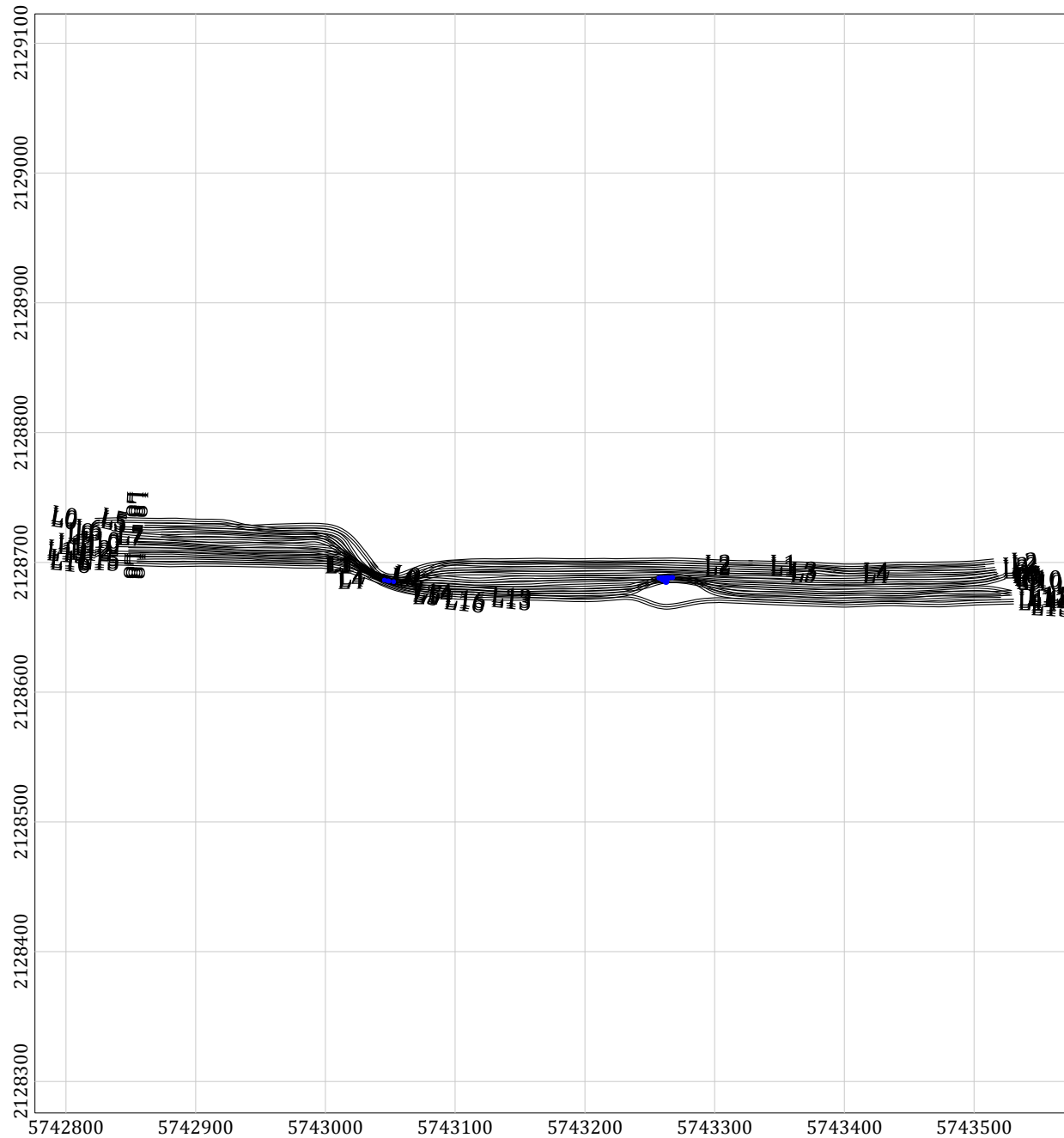

### LEGEND

— Line path  
 ..... Flag Separation  
 Data exceeding max. data spacing: 0.0%

Map Scale:  Scale 1:1525  
 US survey foot  
 NAD83 / California CSRS zone 4

  
 Grid North: 0°0'0"  
 Mag North: 0°0'0"



Client:	
Project:	
Contractor:	
Created by:	Verified by:
Date:	File: 032210-1TA_DATASEP
Page number:	Approved:

# MAP

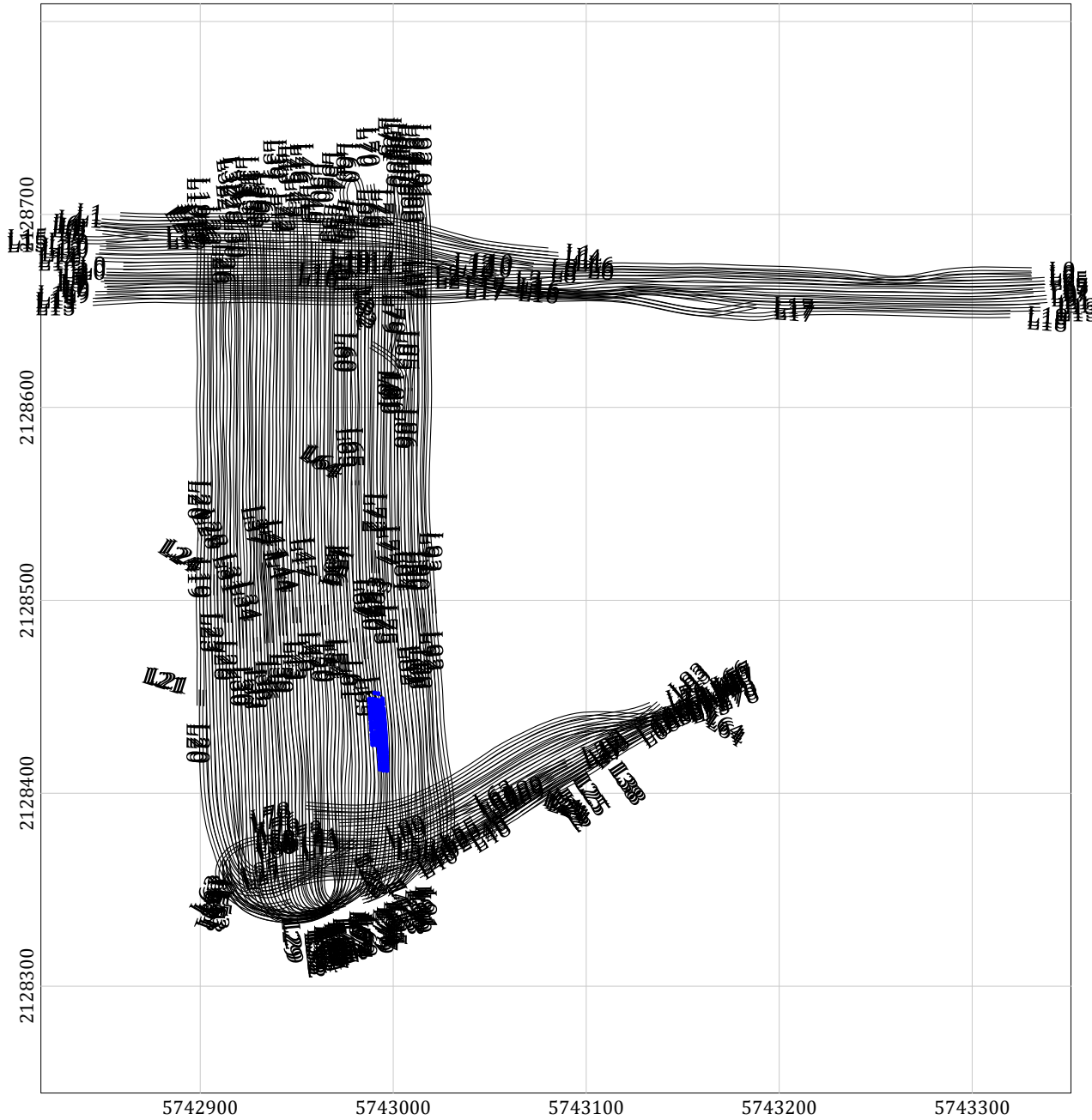
## Sample Separation



### LEGEND

-  Line path
  -  Flag\_Separation
- Data exceeding max. data spacing: 0.1%



Client:	
Project:	
Contractor:	
Created by:	Verified by:
Date:	File: 032310-1TA_DATASEP
Page number:	Approved:

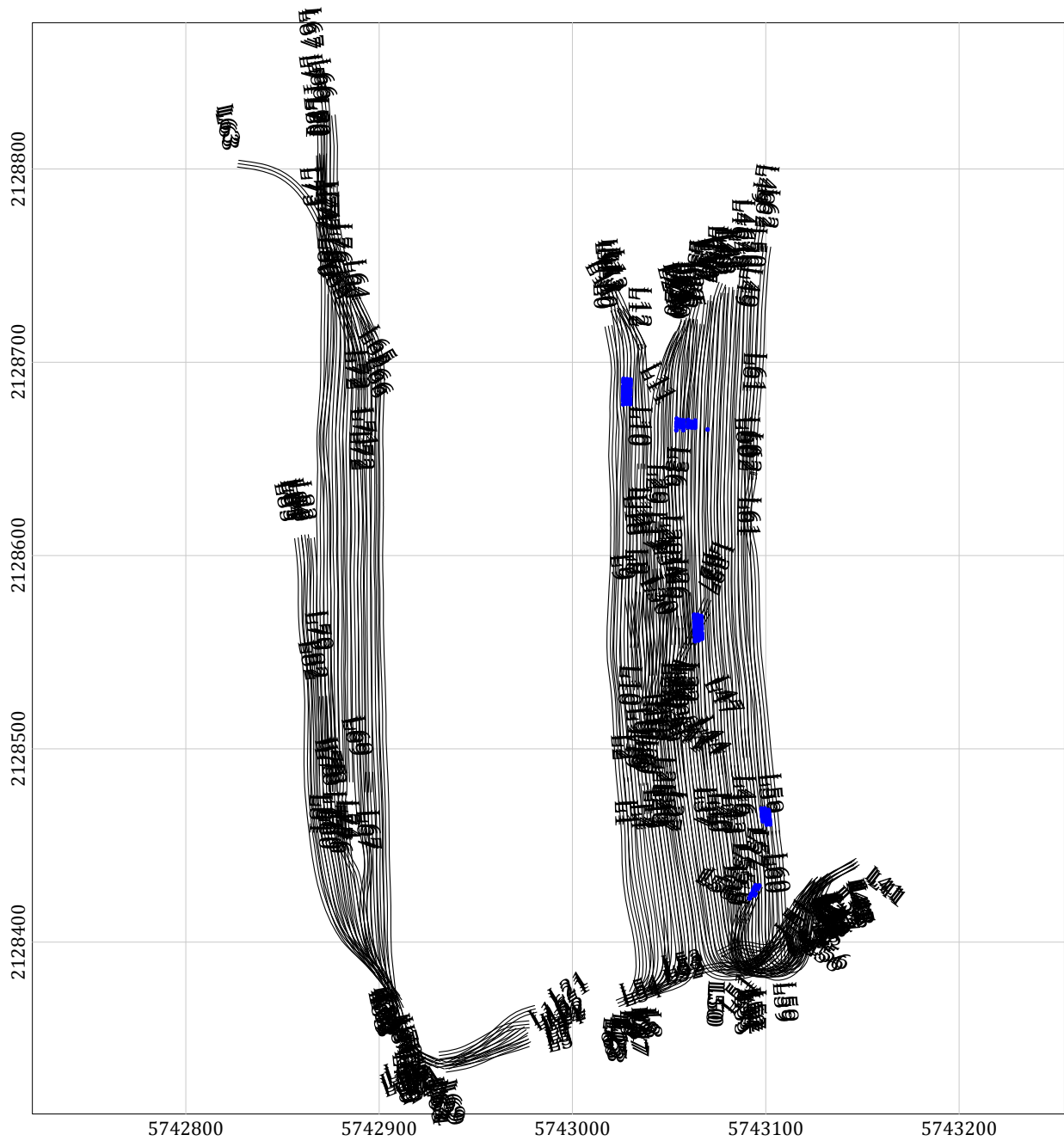

# MAP

## Sample Separation

### LEGEND

-  Line path
  -  Flag Separation
- Data exceeding max. data spacing: 0.1%



Client:	
Project:	
Contractor:	
Created by:	Verified by:
Date: 2010/04/03 File: 032410-1TA_DATASEP	
Page number:	Approved:



# MAP

## Sample Separation

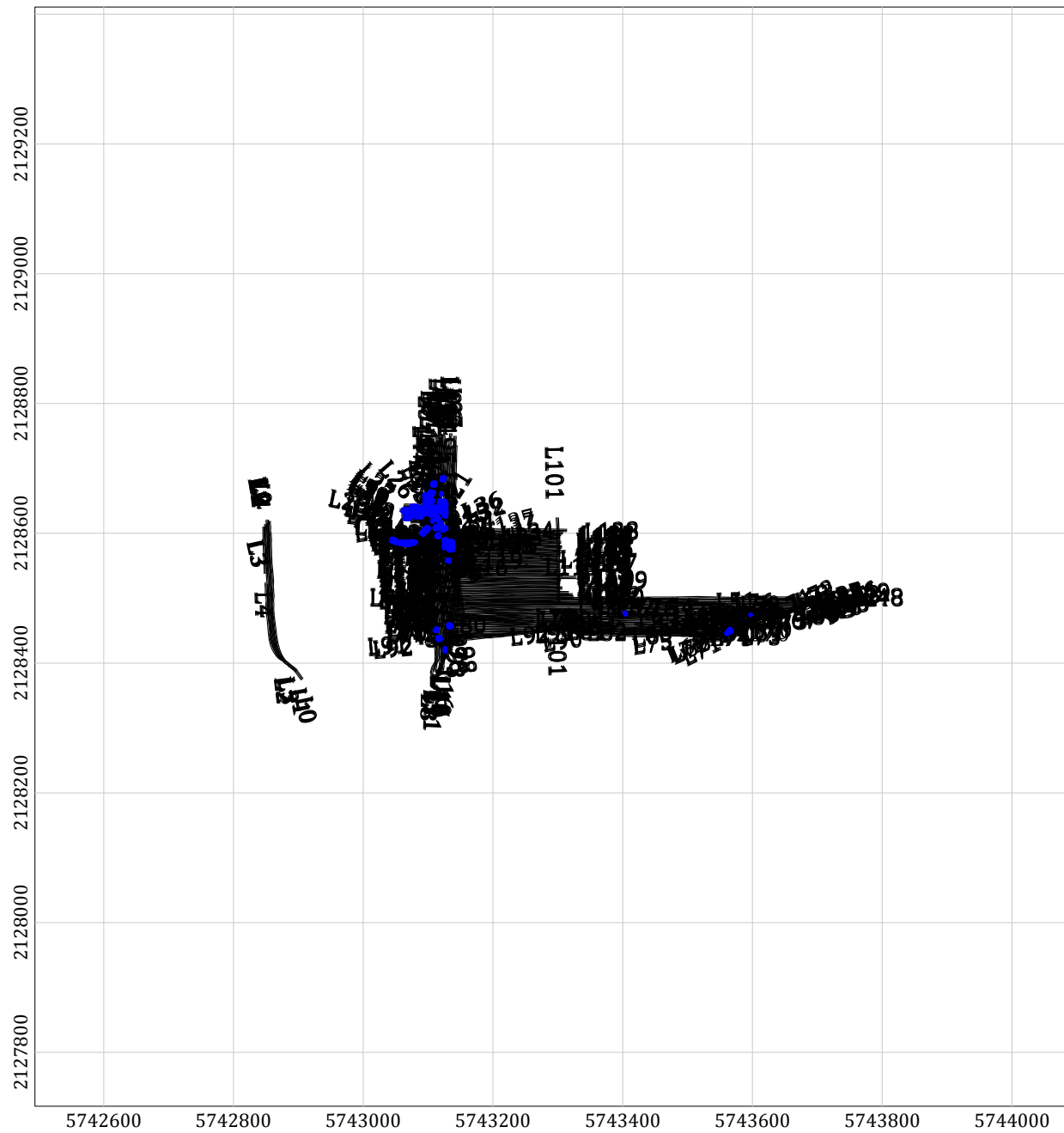

### LEGEND

- Line path
- ..... Flag Separation

Data exceeding max. data spacing: 0.6%

Map Scale:

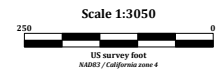

Client:

Project:

Contractor:

Created by:

Verified by:

Date: 2010/04/03 File: 032510-1TA\_DATASEP

Page number:

Approved:



# MAP

## Sample Separation

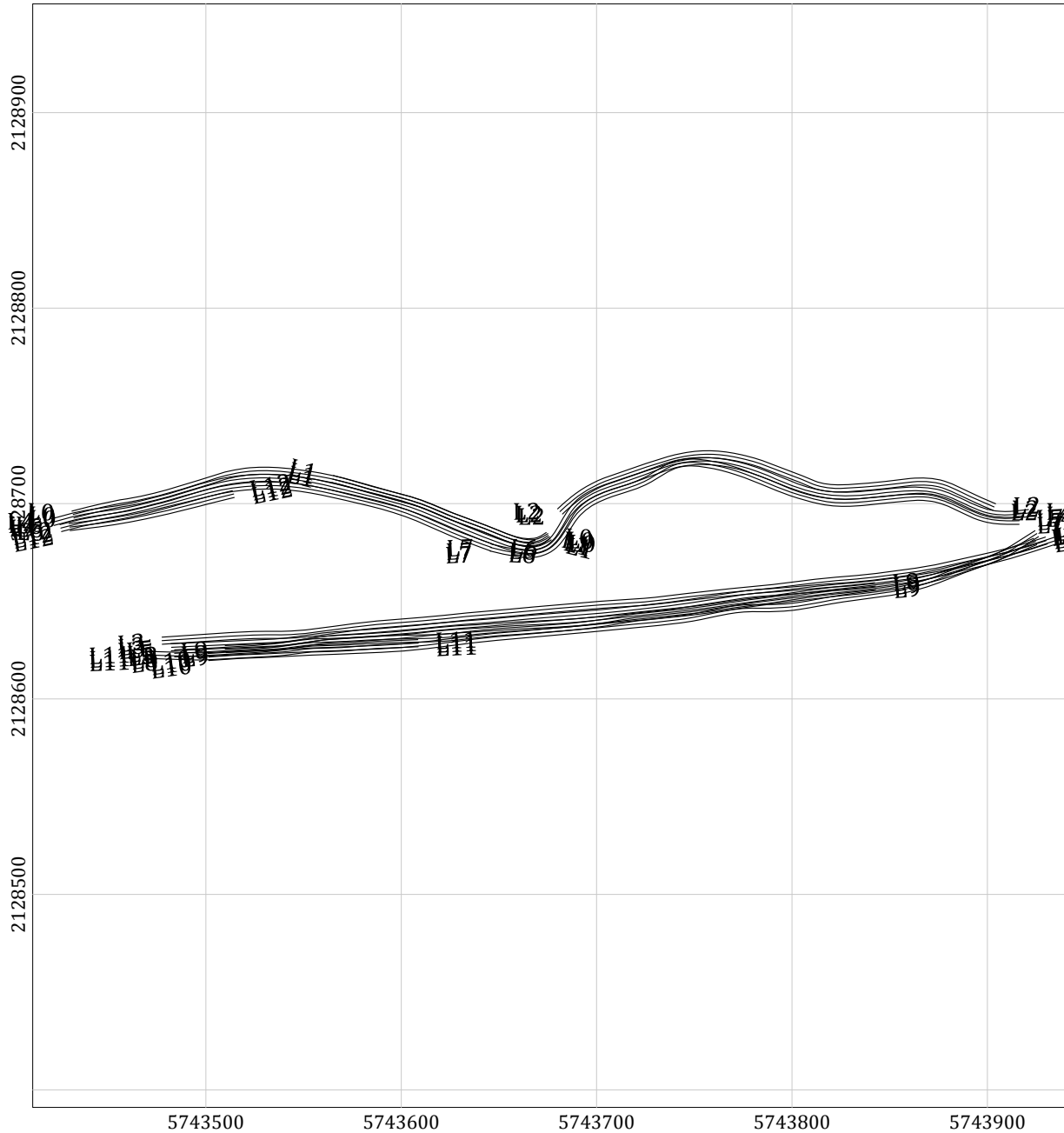

### LEGEND

- Line path
  - ..... Flag Separation
- Data exceeding max. data spacing: 0.0%



Client:	
Project:	
Contractor:	
Created by:	Verified by:
Date: 2010/04/03 File: 032610-1TA_DATASEP	
Page number:	Approved:



# MAP

## Sample Separation

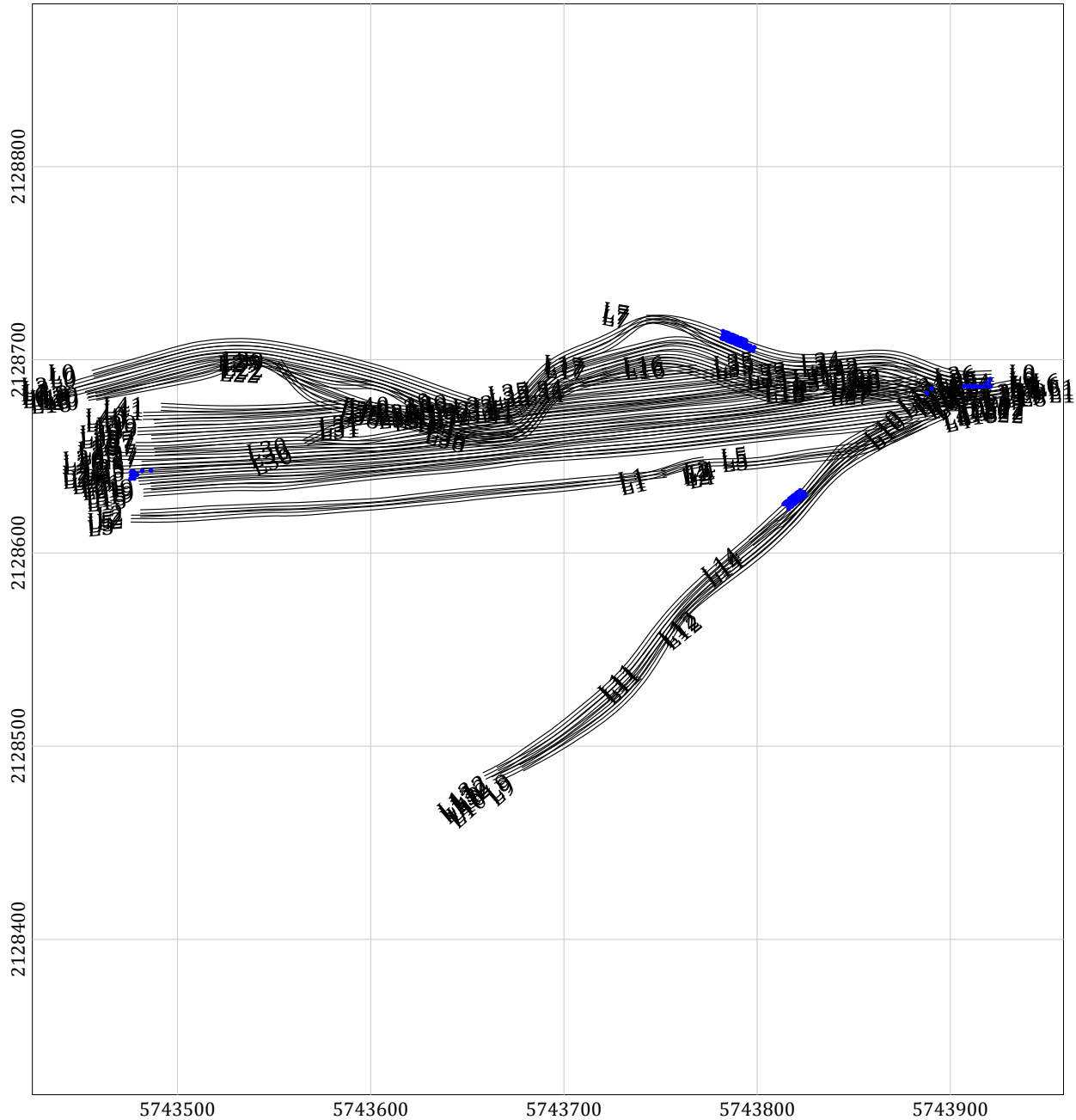

### LEGEND

- Line path
  - Flag\_Separation
- Data exceeding max. data spacing: 0.1%



Client:	
Project:	
Contractor:	
Created by:	Verified by:
Date: 2010/04/03 File: 032610-2TA_DATASEP	
Page number:	Approved:





# MAP

## Sample Separation

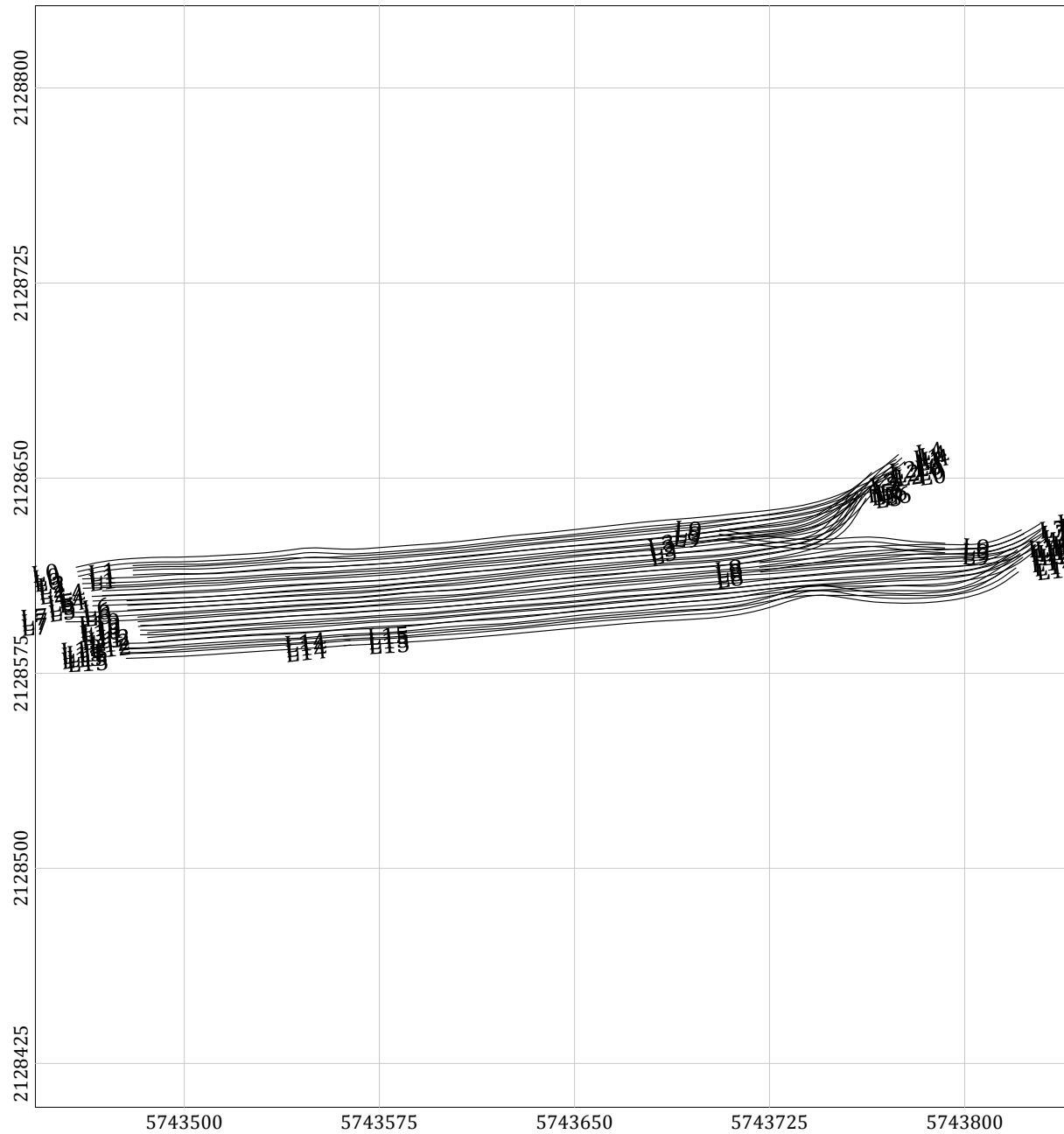

### LEGEND

- Line path
- ..... Flag Separation

Data exceeding max. data spacing: 0.0%

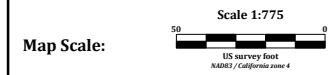

Client:

Project:

Contractor:

Created by:

Verified by:

Date: 2010/04/03 File: 032910-1TA\_DATASEP

Page number:

Approved:



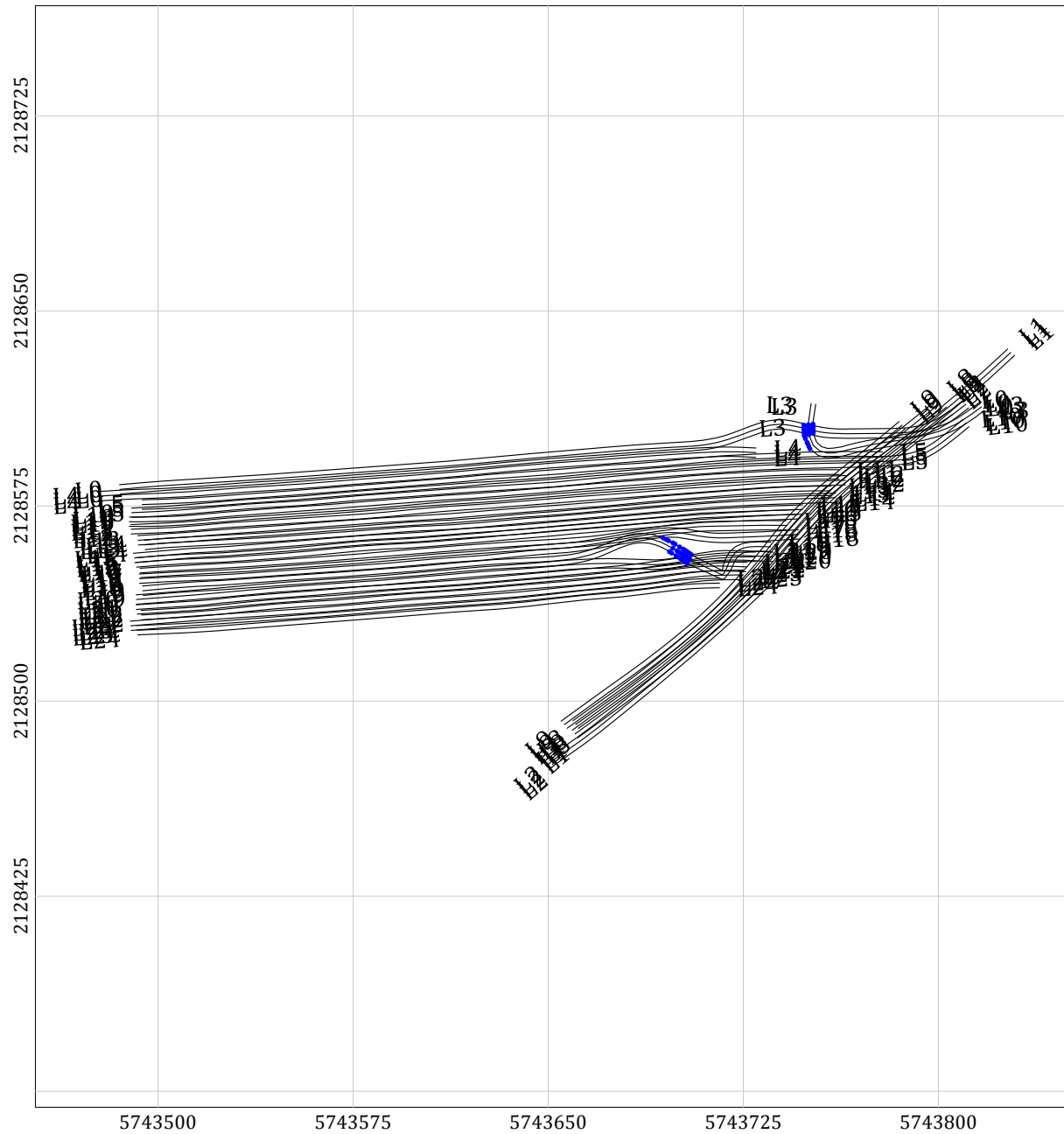

# MAP

## Sample Separation



### LEGEND

-  Line path
  -  Flag Separation
- Data exceeding max. data spacing: 0.1%



Client:	
Project:	
Contractor:	
Created by:	Verified by:
Date: 2010/04/03 File: 040110-1TA_DATASEP	
Page number:	Approved:



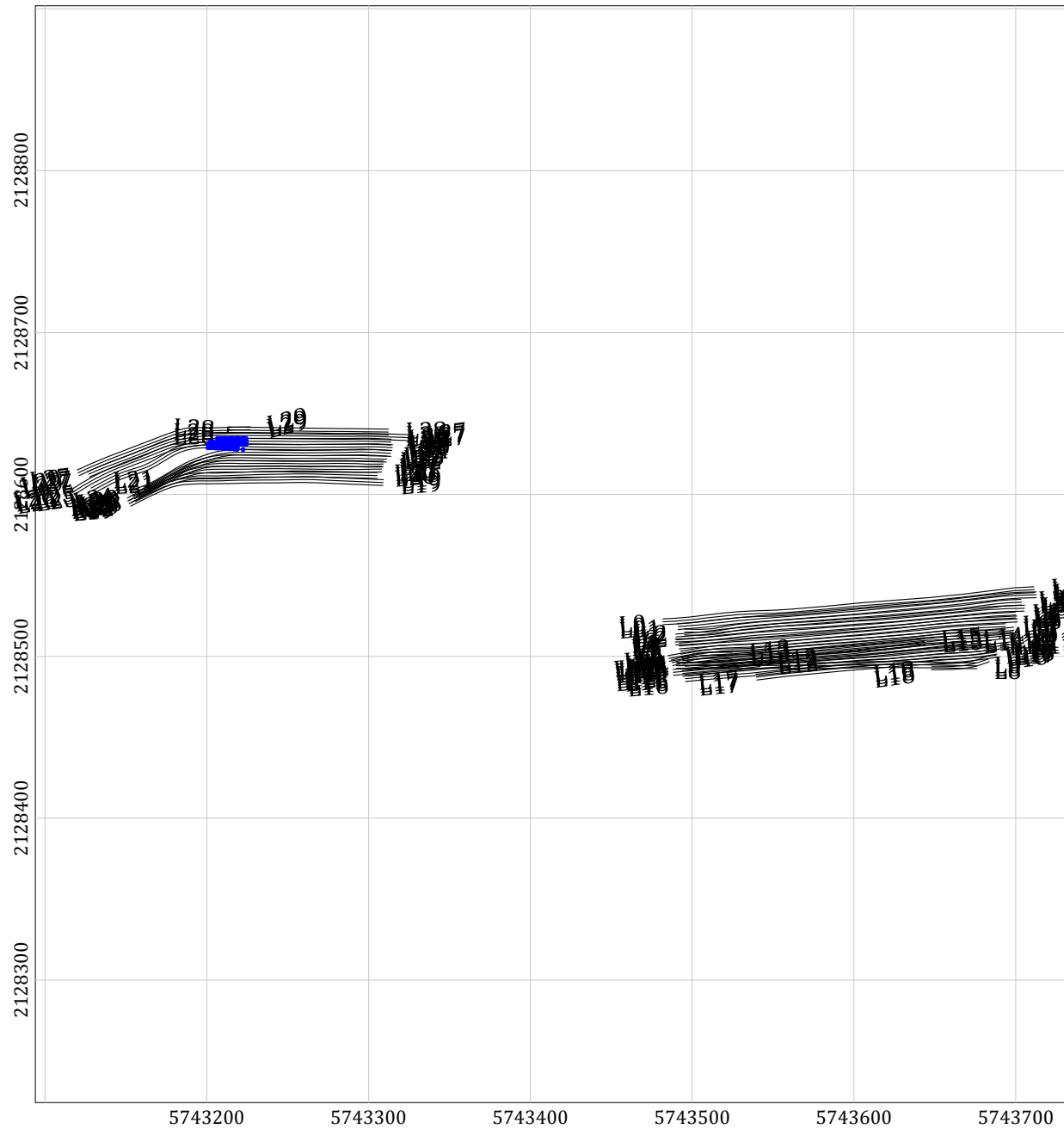

# MAP

## Sample Separation



### LEGEND

-  Line path
  -  Flag Separation
- Data exceeding max. data spacing: 0.2%



Client:

Project:

Contractor:

Created by:

Verified by:

Date: 2010/04/03 File: 040210-1TA\_DATASEP

Page number:

Approved:



# MAP

## Sample Separation

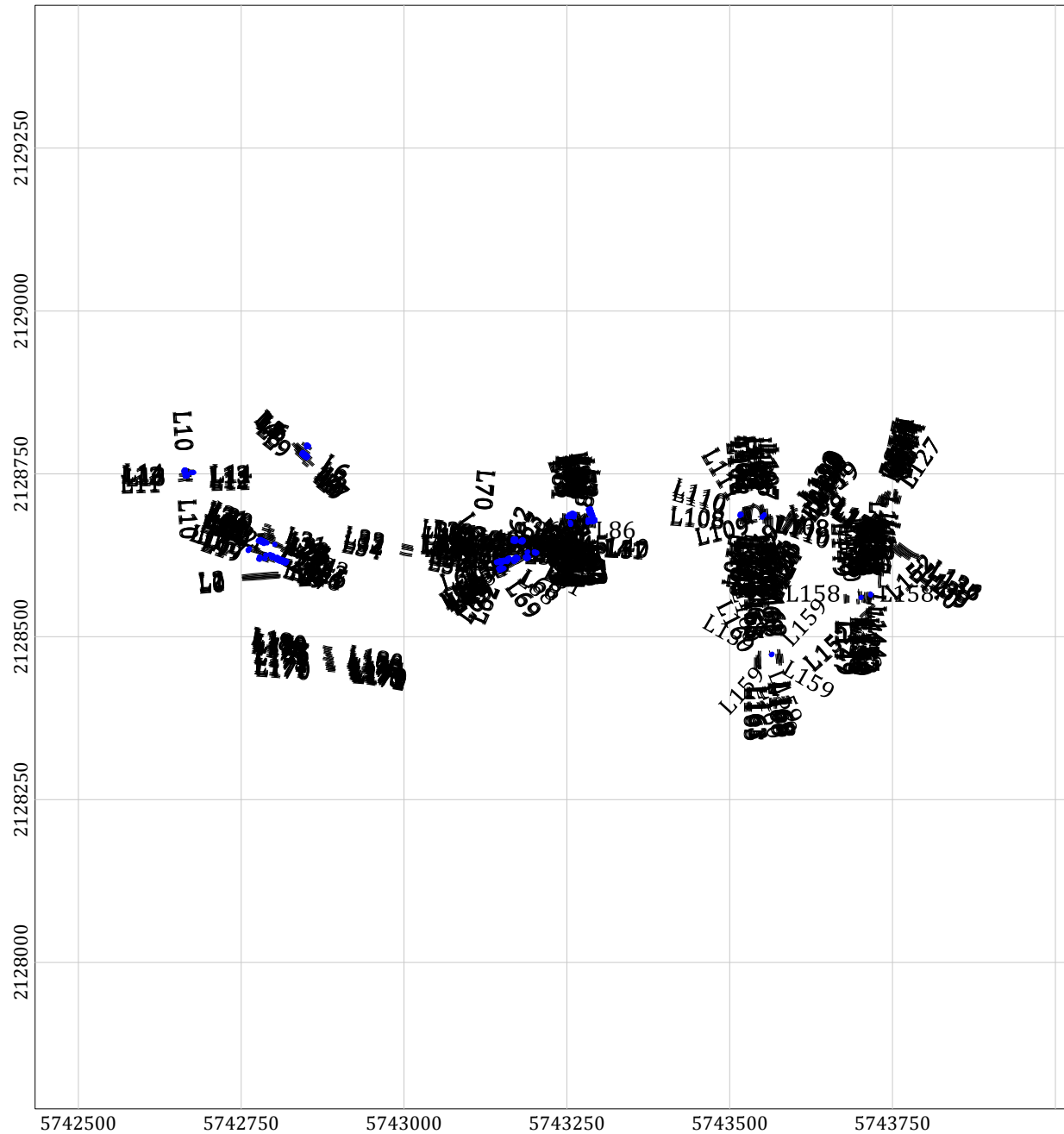

### LEGEND

-  Line path
  -  Flag\_Separation
- Data exceeding max. data spacing: 1.1%

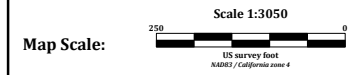

Client:	
Project:	
Contractor:	
Created by:	Verified by:
Date: 2010/04/03 File: 040510-1TA_DATASEP	
Page number:	Approved:



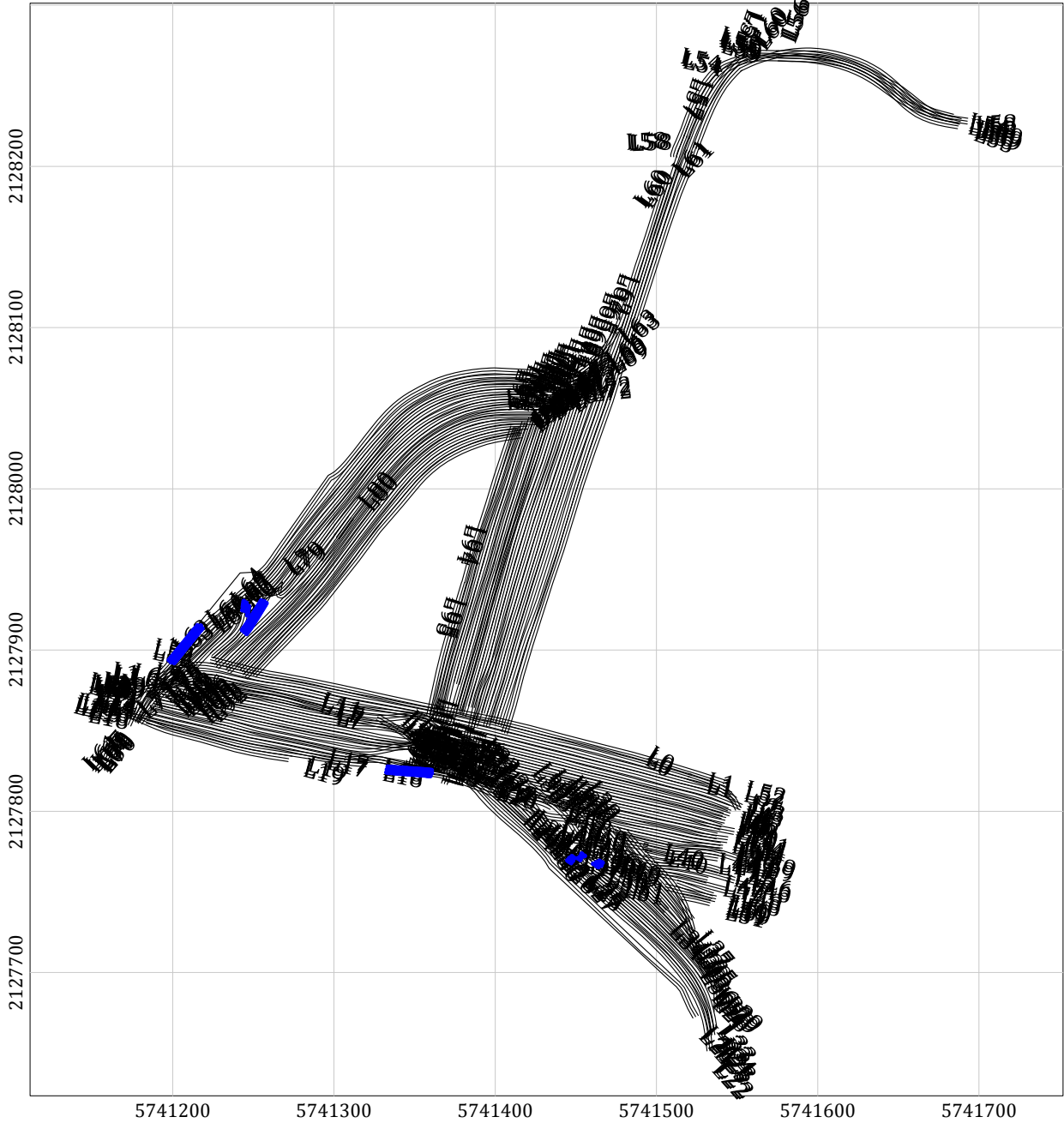



# MAP

## Sample Separation

### LEGEND

-  Line path
  -  Flag Separation
- Data exceeding max. data spacing: 0.2%



Client:	
Project:	
Contractor:	
Created by:	Verified by:
Date: 2010/04/03 File: 040610-1TA_DATASEP	
Page number:	Approved:



# MAP

## Sample Separation

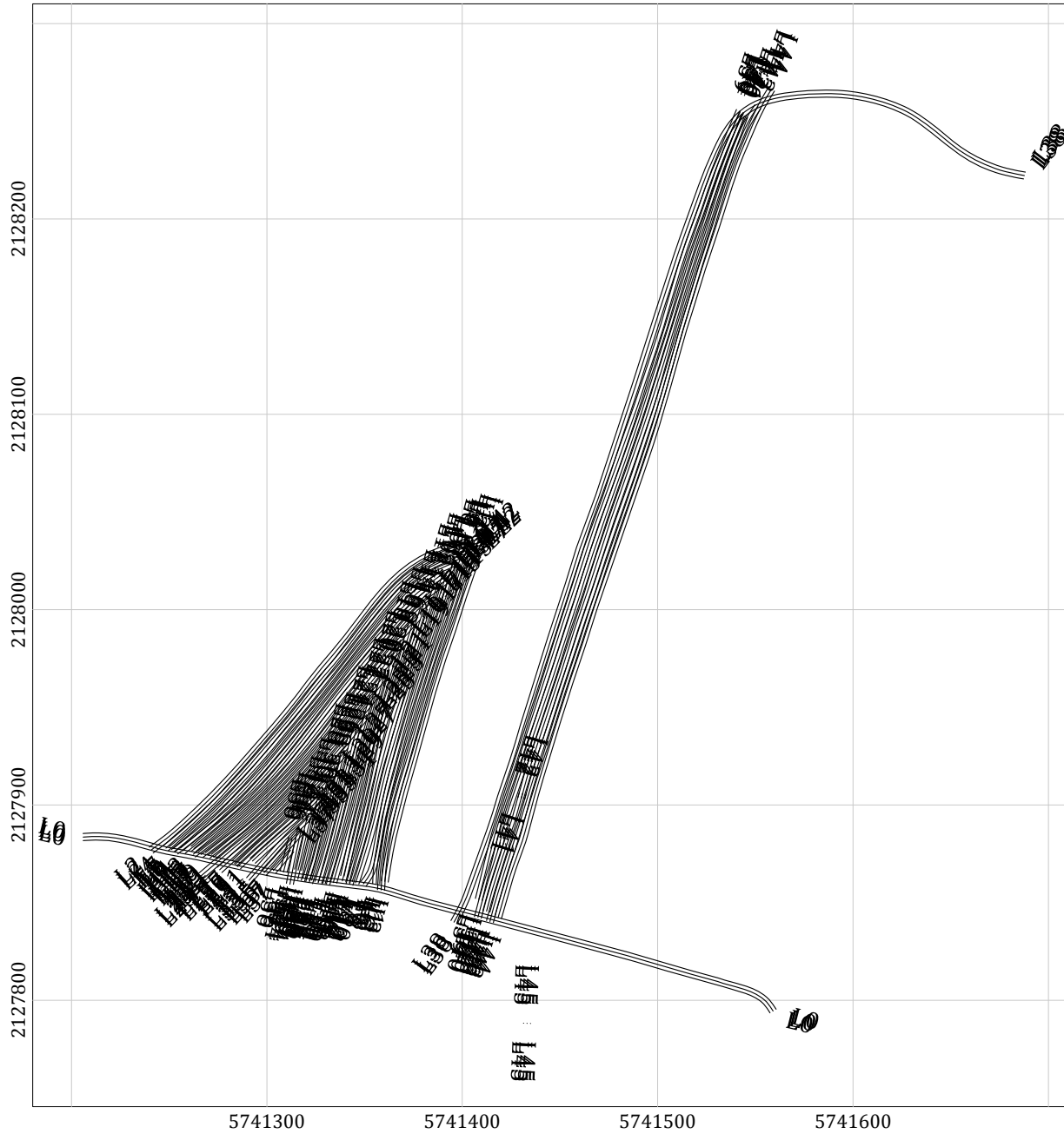

### LEGEND

- Line path
  - Flag\_Separation
- Data exceeding max. data spacing: 0.0%



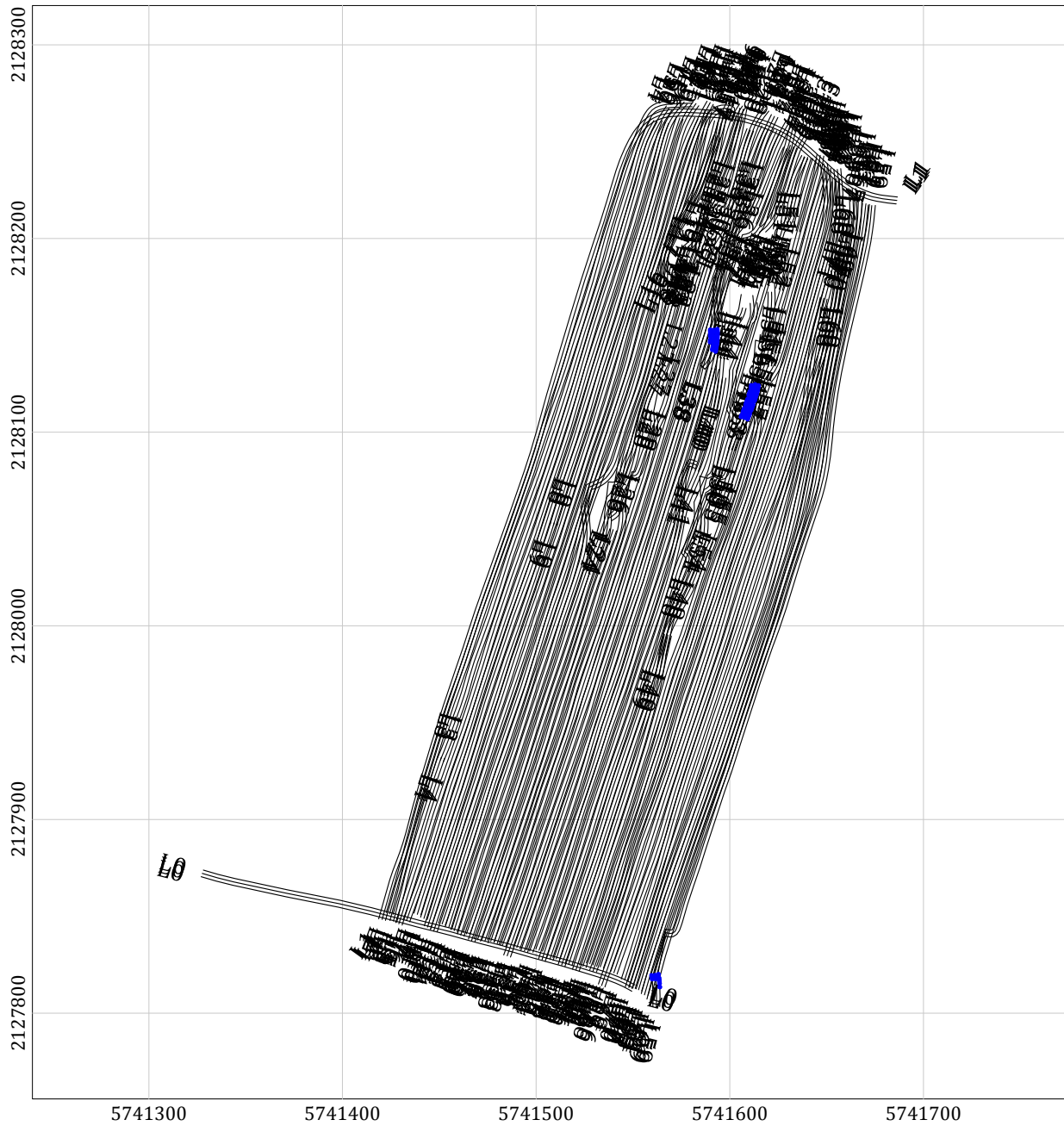

Client:	
Project: Fort Ord- Parker Flats	
Contractor:	
Created by:	Verified by:
Date:	File: 041210-1TA_DATASEP
Page number:	Approved:



# MAP

## Sample Separation

### LEGEND

-  Line path
  -  Flag Separation
- Data exceeding max. data spacing: 0.1%





Client:	
Project: Fort Ord- Parker Flats	
Contractor:	
Created by:	Verified by:
Date:	File: 041210-2TA_DATASEP
Page number:	Approved:

# MAP

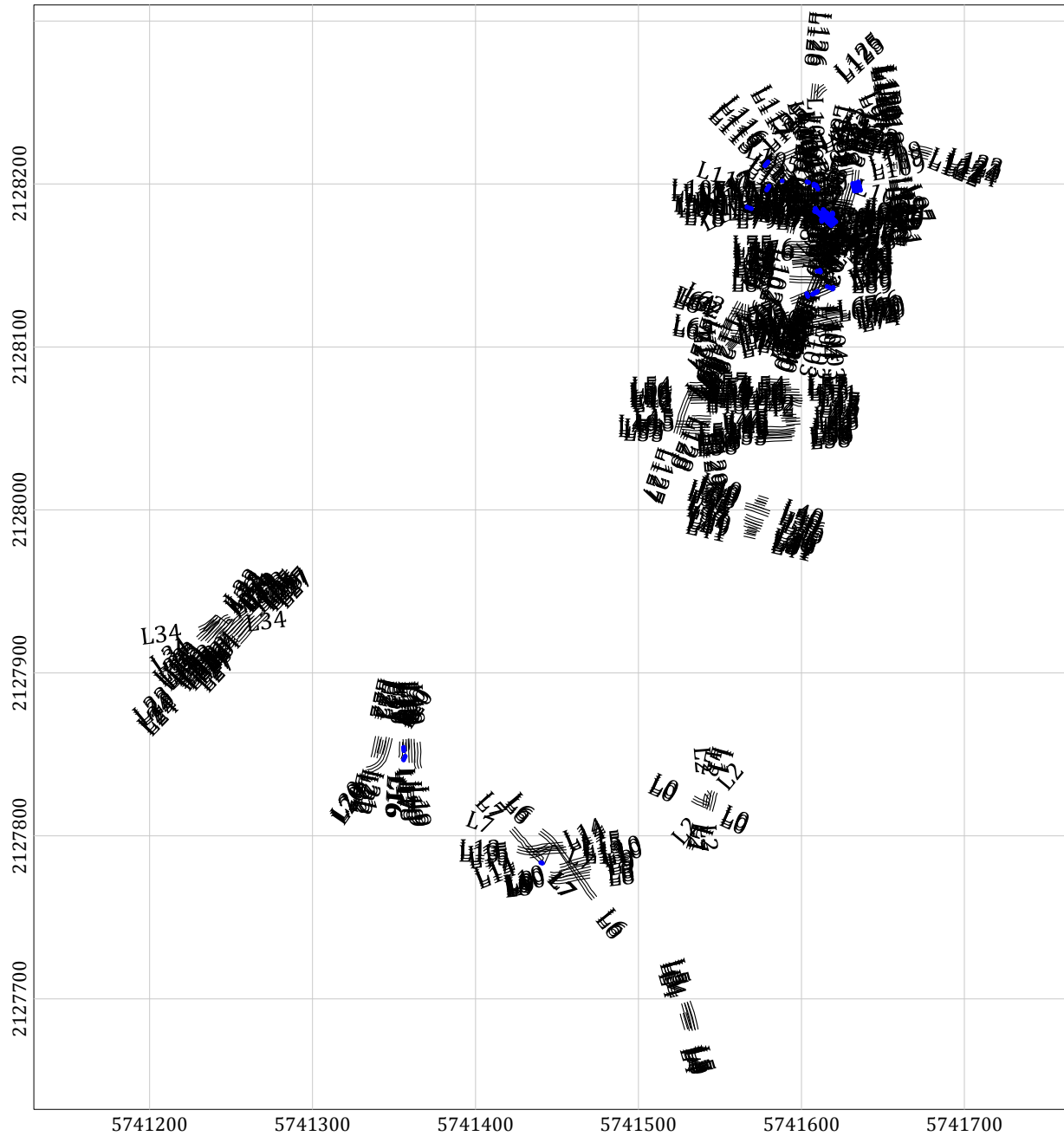
## Sample Separation



### LEGEND

-  Line path
  -  Flag\_Separation
- Data exceeding max. data spacing: 0.6%



Client:

Project: Fort Ord- Parker Flats

Contractor:

Created by: \_\_\_\_\_ Verified by: \_\_\_\_\_

Date: \_\_\_\_\_ File: 042210-1TA\_DATASEP

Page number: \_\_\_\_\_ Approved: \_\_\_\_\_



# MAP

## Sample Separation

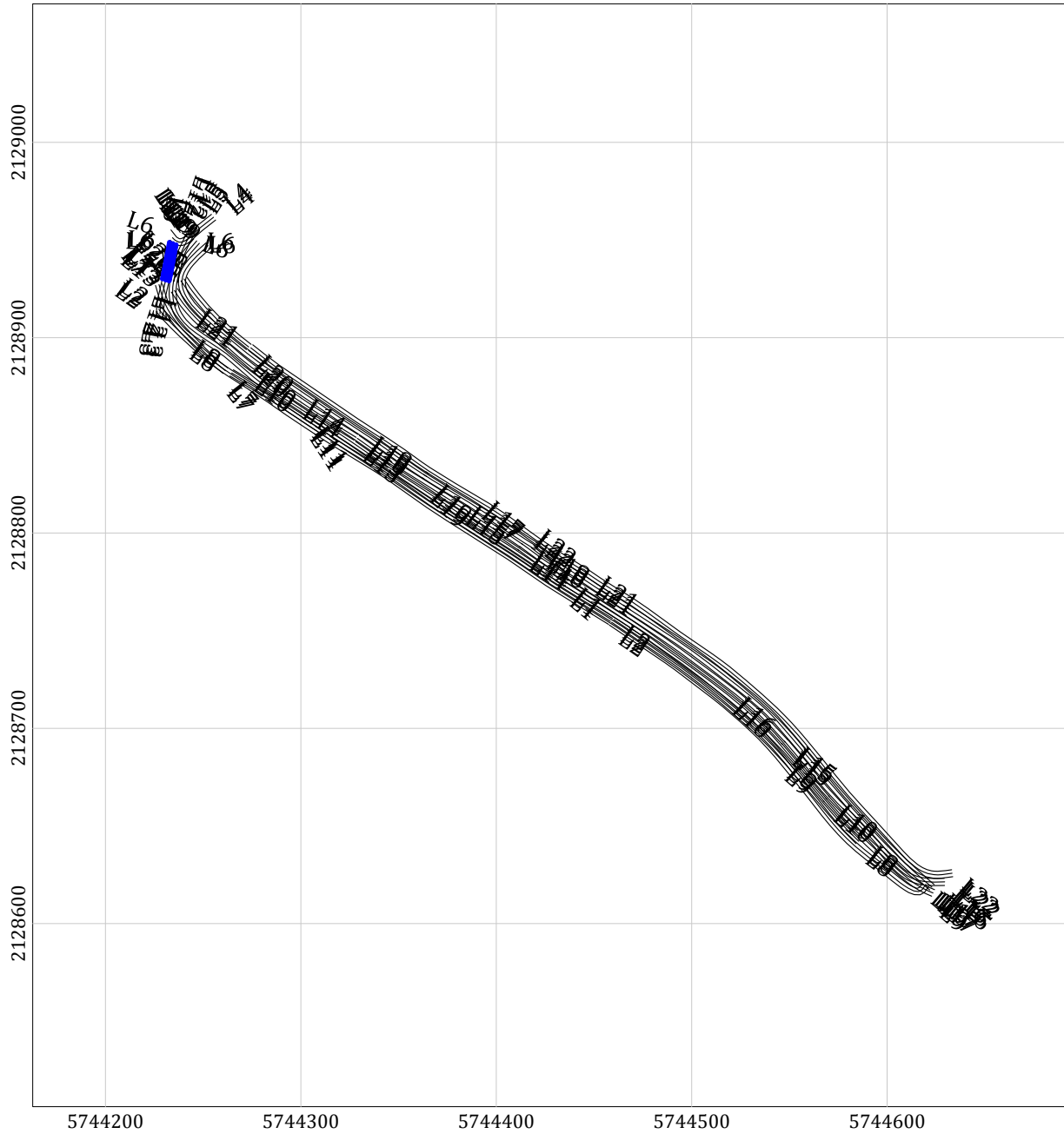

### LEGEND

- Line path
  - Flag\_Separation
- Data exceeding max. data spacing: 0.3%





Client:	
Project: Fort Ord- Parker Flats	
Contractor:	
Created by:	Verified by:
Date:	File: 042210-2TA_DATASEP
Page number:	Approved:

# MAP

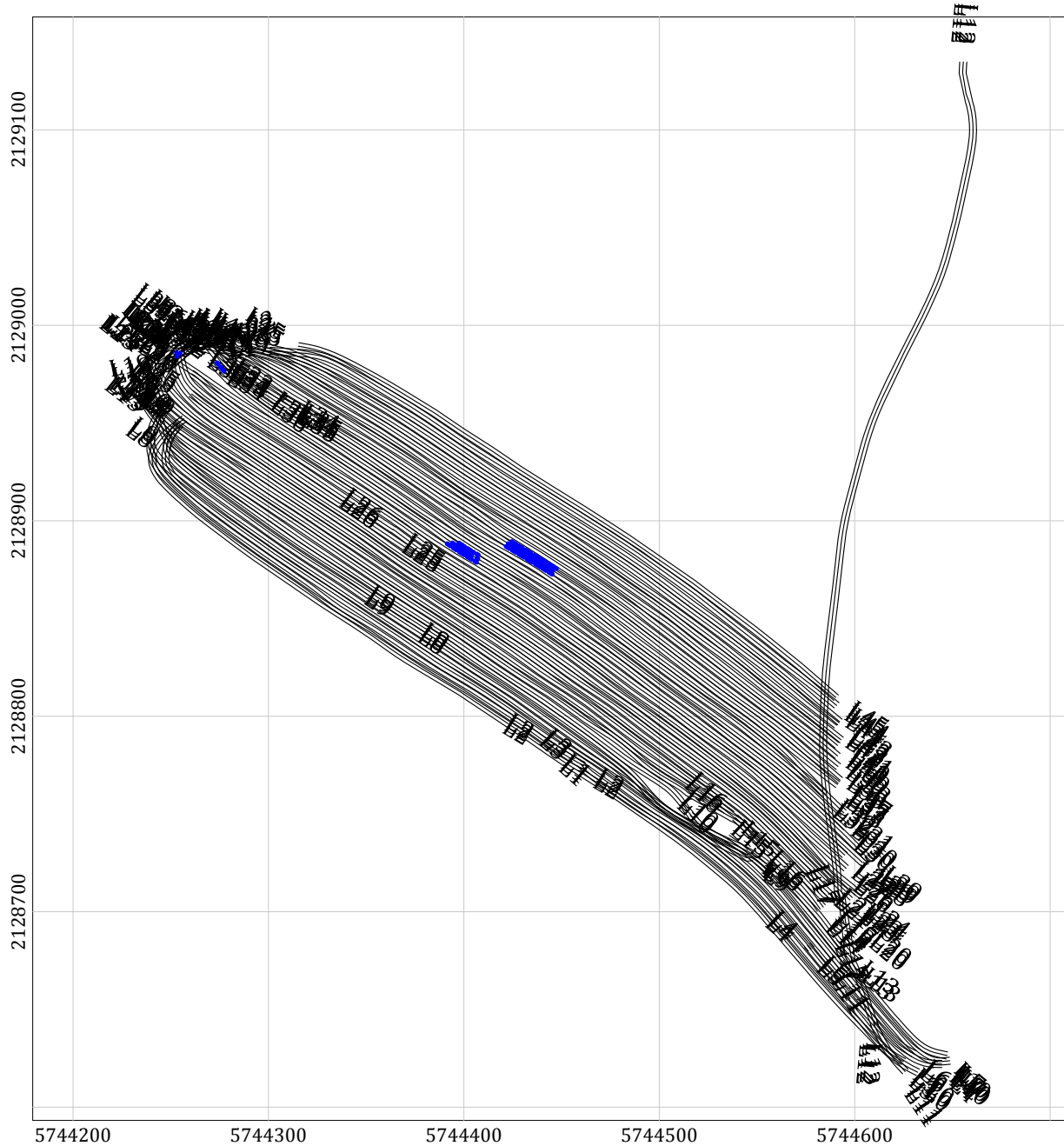
## Sample Separation



### LEGEND

-  Line path
  -  Flag Separation
- Data exceeding max. data spacing: 0.1%



Client:	
Project: Fort Ord- Parker Flats	
Contractor:	
Created by:	Verified by:
Date:	File: 042310-1TA_DATASEP
Page number:	Approved:

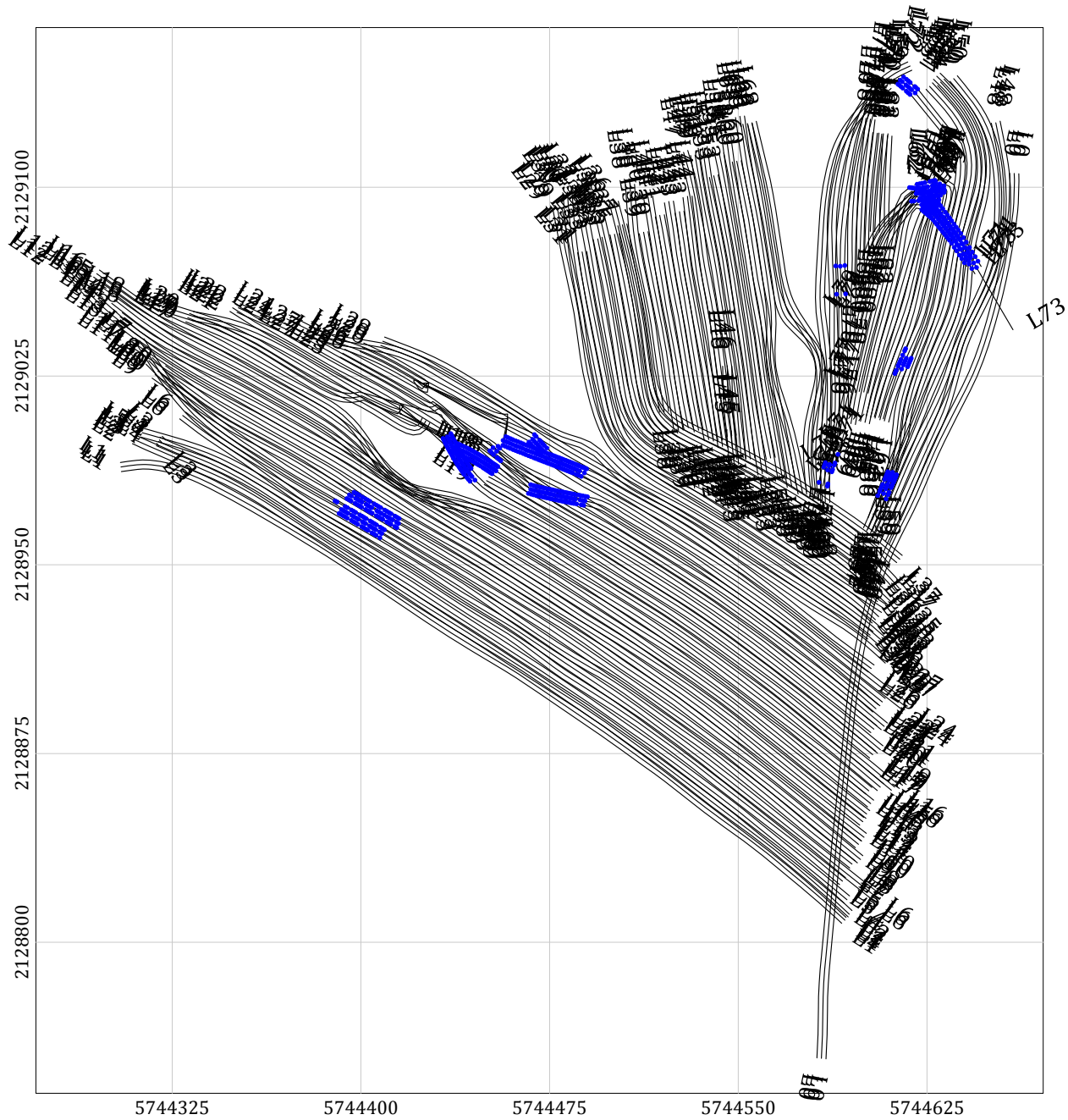

# MAP

## Sample Separation

### LEGEND

-  Line path
  -  Flag Separation
- Data exceeding max. data spacing: 0.7%



Client:	
Project: Fort Ord- Parker Flats	
Contractor:	
Created by:	Verified by:
Date:	File: 042610-1TA_DATASEP
Page number:	Approved:

# MAP

## Sample Separation

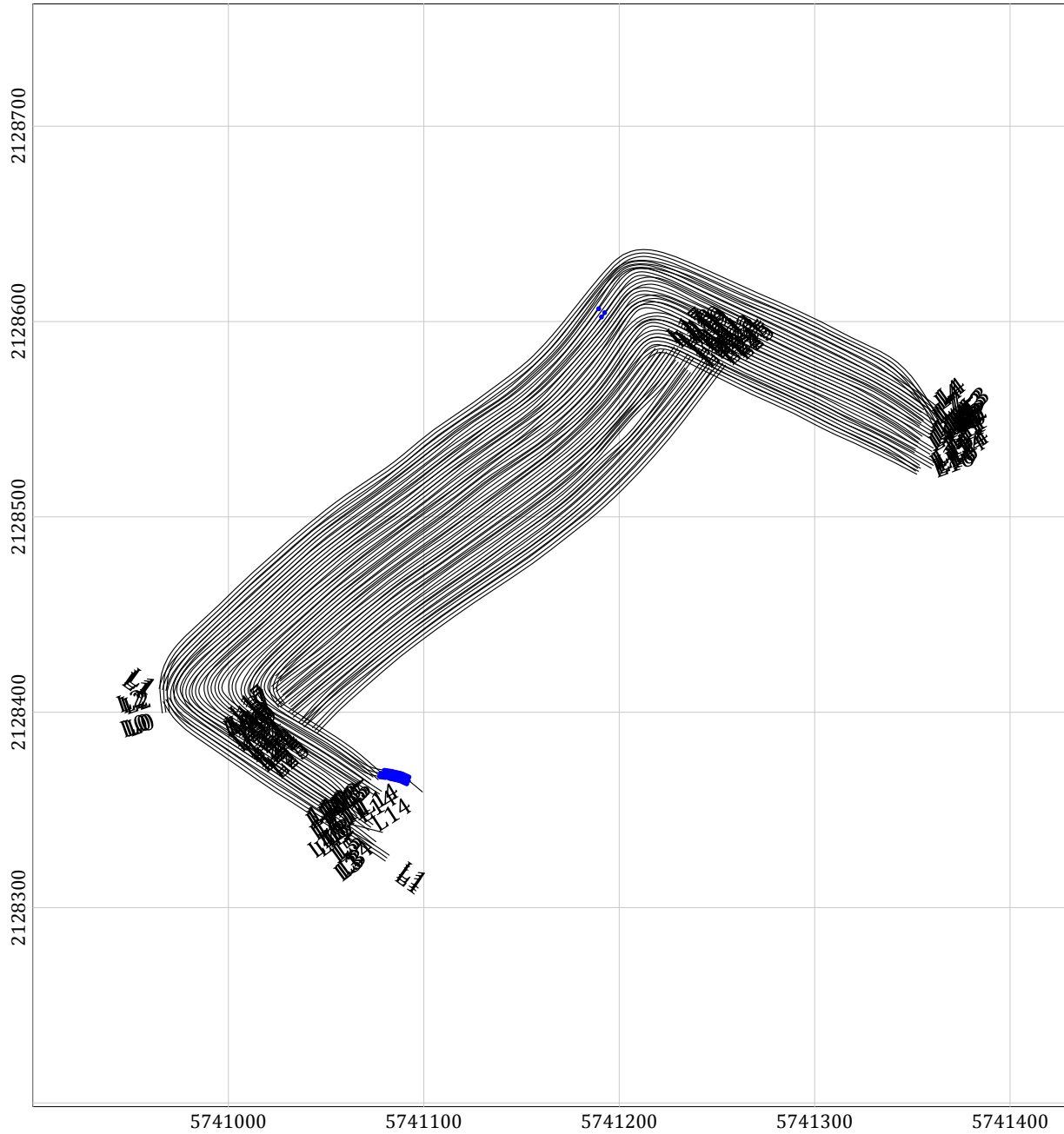

### LEGEND

- Line path
  - - - - - Flag\_Separation
- Data exceeding max. data spacing: 0.1%



Client:	
Project: Fort Ord- Parker Flats	
Contractor:	
Created by:	Verified by:
Date:	File: 042610-2TA_DATASEP
Page number:	Approved:

# MAP

## Sample Separation

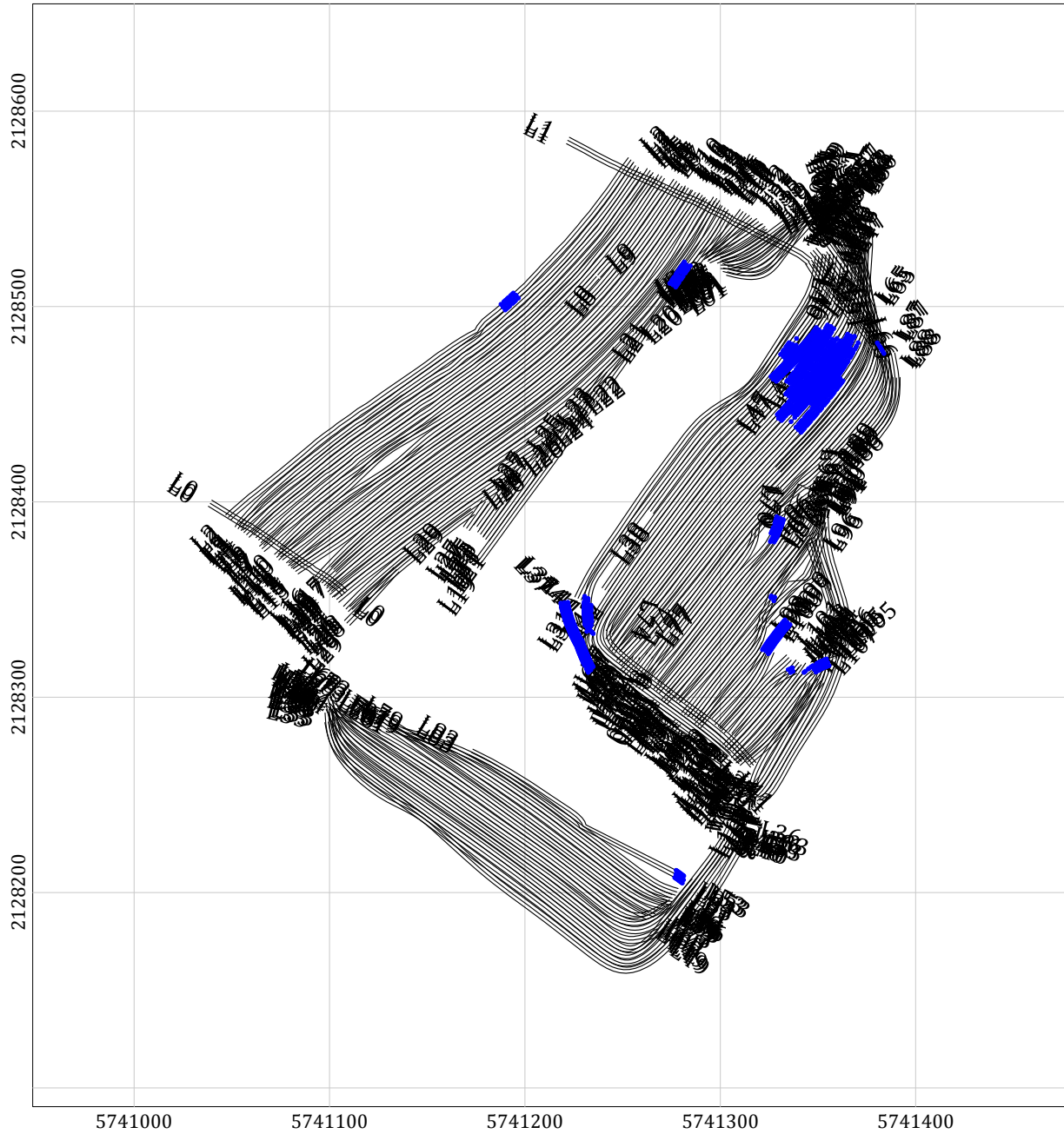

### LEGEND

-  Line path
  -  Flag Separation
- Data exceeding max. data spacing: 1.0%

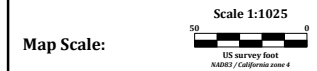

Client:	
Project: Fort Ord- Parker Flats	
Contractor:	
Created by:	Verified by:
Date:	File: 042710-1TA_DATASEP
Page number:	Approved:

# MAP

## Sample Separation

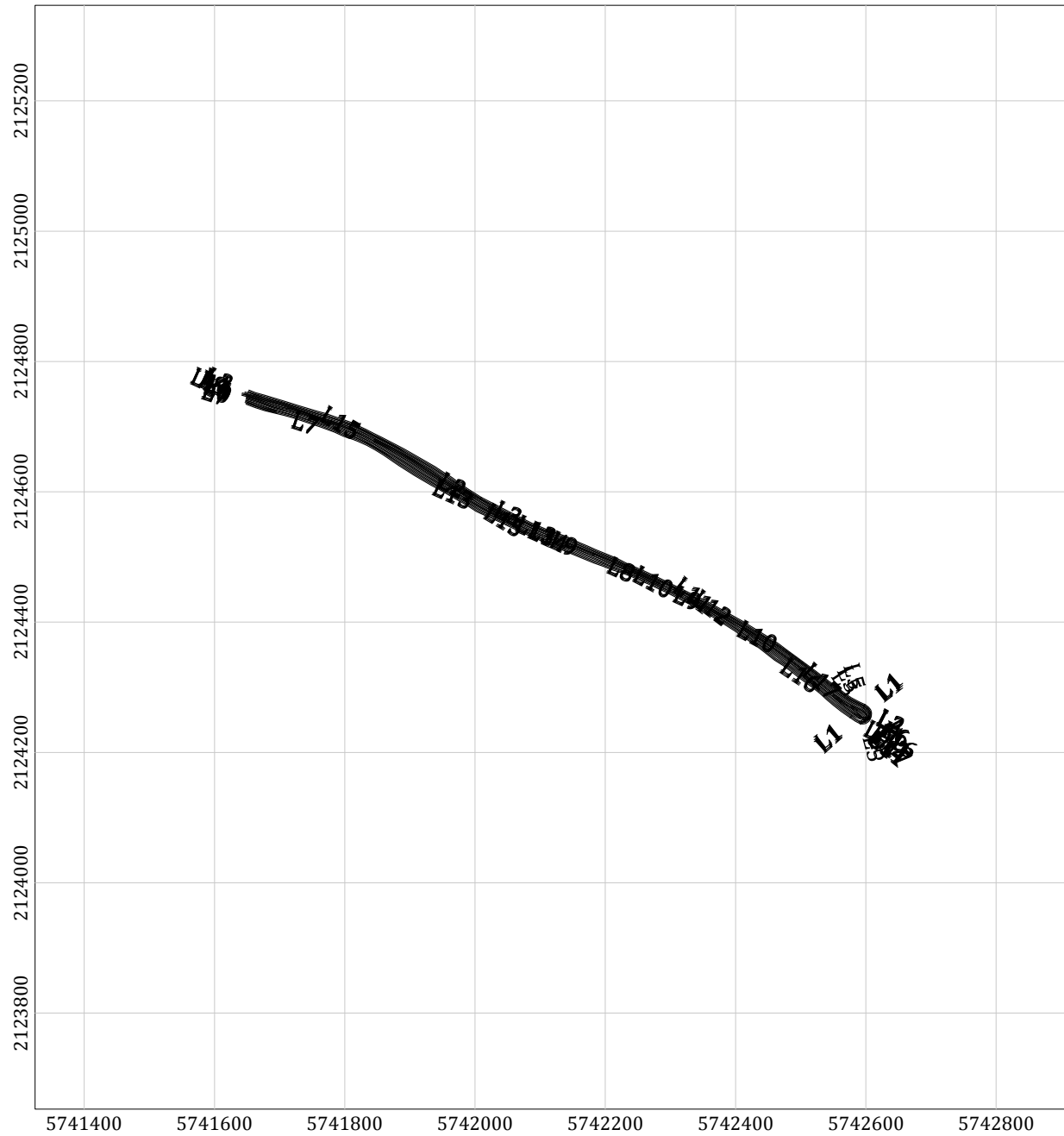

### LEGEND

- Line path
  - ..... Flag Separation
- Data exceeding max. data spacing: 0.0%

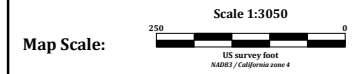

Client:	
Project: Fort Ord- Parker Flats	
Contractor:	
Created by:	Verified by:
Date:	File: 042810-1TA_DATASEP
Page number:	Approved:

# MAP

## Sample Separation

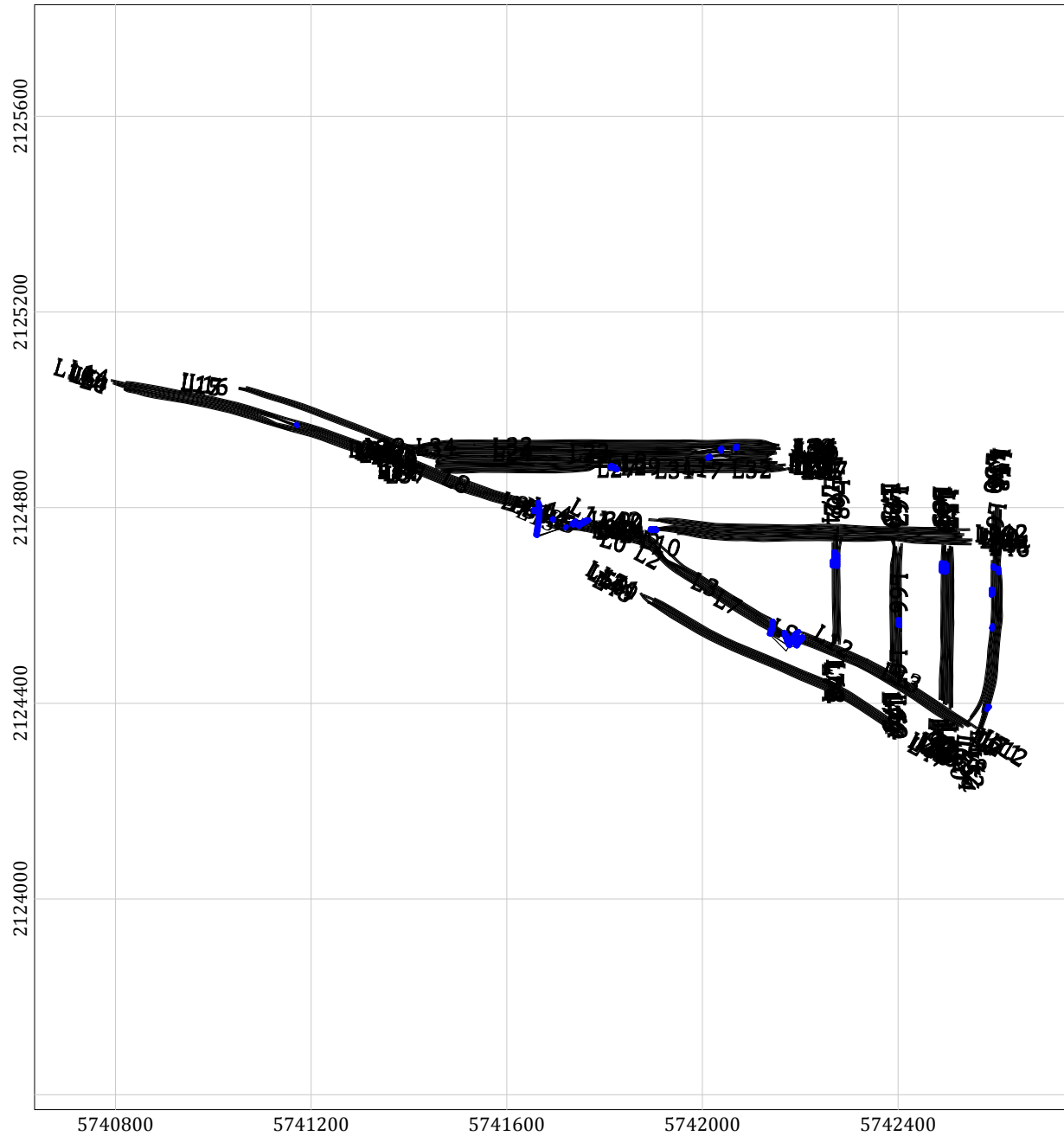

### LEGEND

- Line path
  - Flag Separation
- Data exceeding max. data spacing: 0.4%



Client:	
Project: Fort Ord- Parker Flats	
Contractor:	
Created by:	Verified by:
Date:	File: 050310-1TA_DATASEP
Page number:	Approved:

# MAP

## Sample Separation

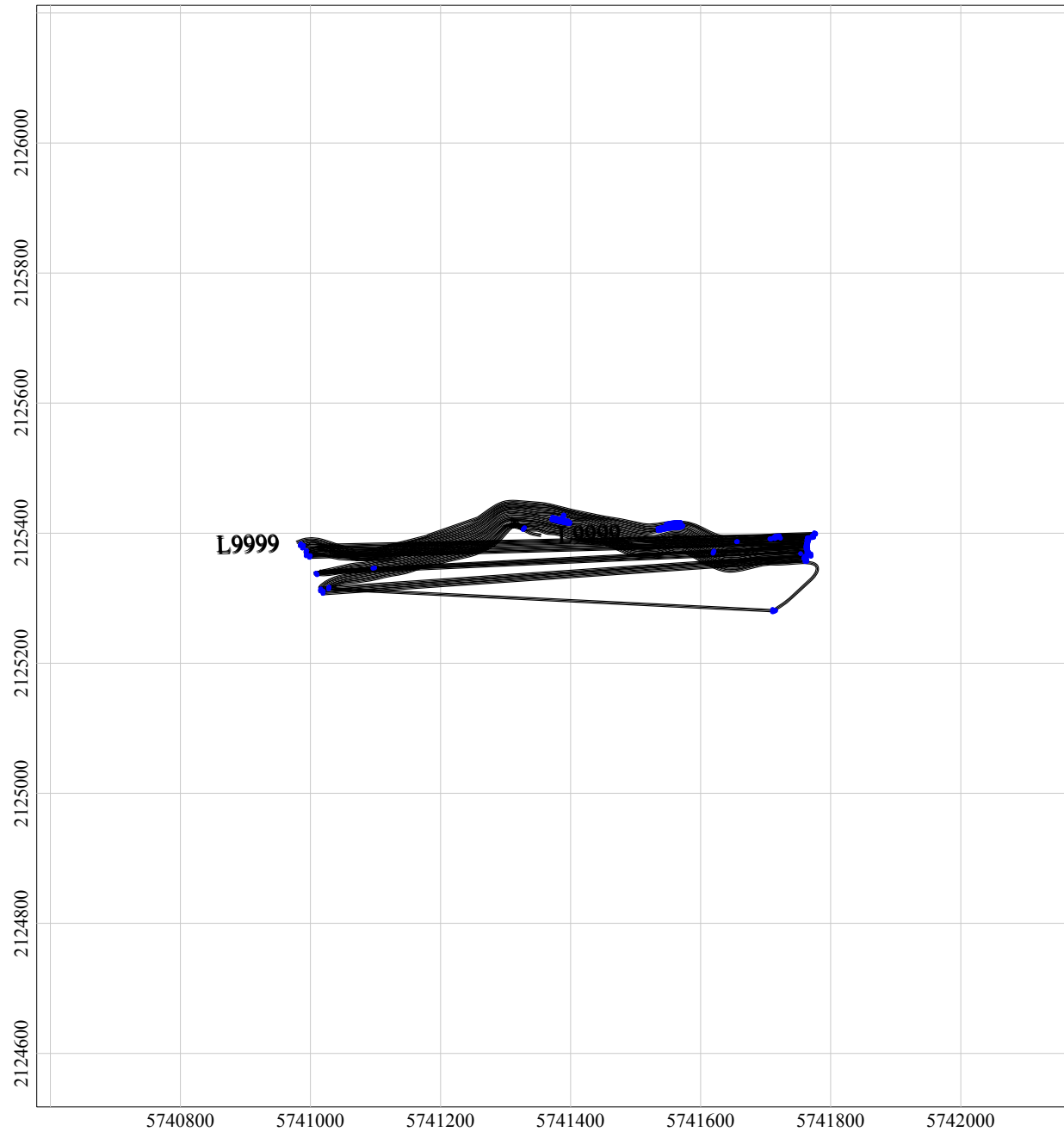

### LEGEND

- Line path
  - Flag\_Separation
- Data exceeding max. data spacing: 0.5%



<b>Client:</b>	
<b>Project: Fort Ord- Parker Flats</b>	
<b>Contractor:</b>	
<b>Created by:</b>	<b>Verified by:</b>
<b>Date:</b>	<b>File: 090110-ITA_DATASEP</b>
<b>Page number:</b>	<b>Approved:</b>



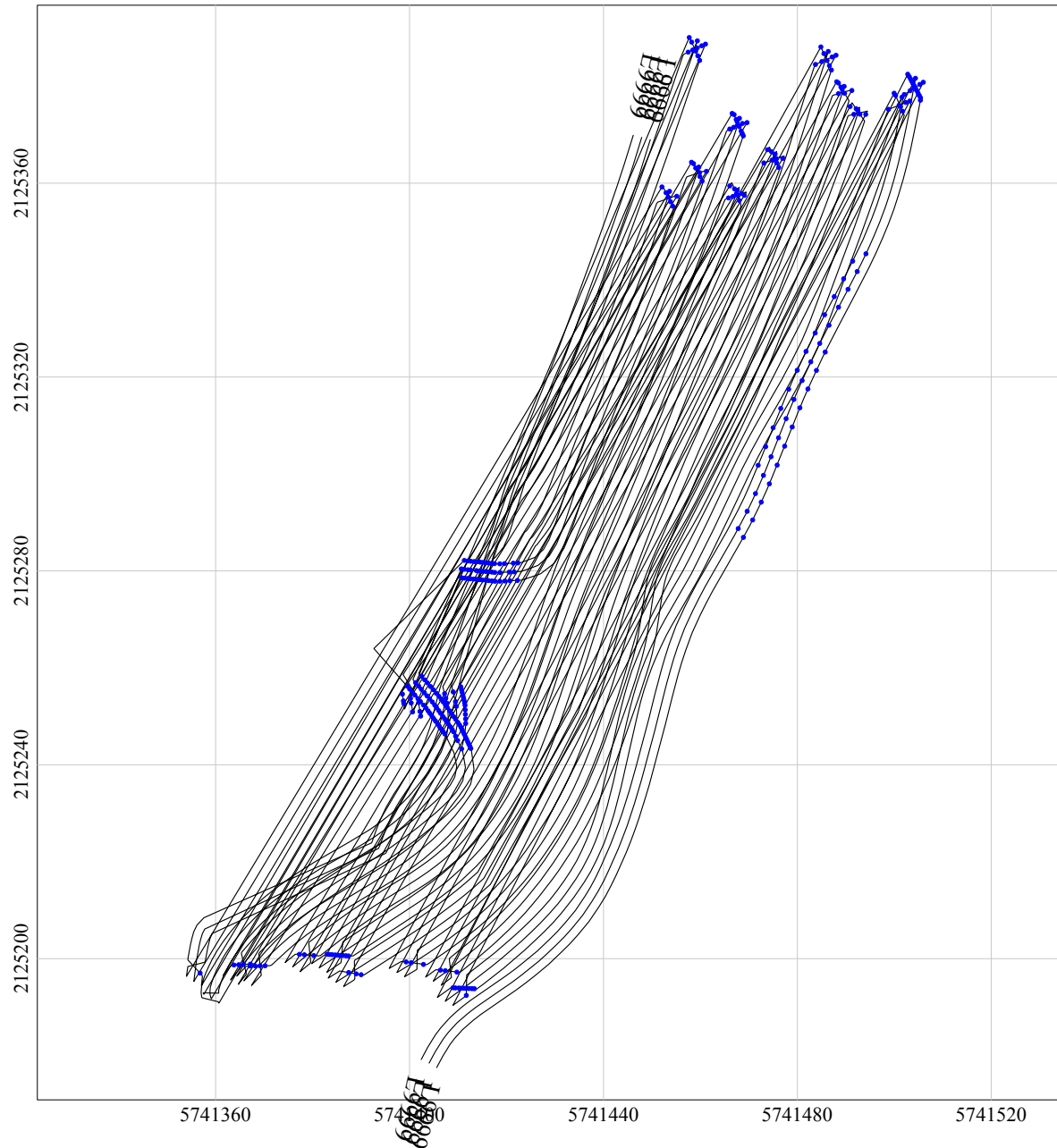

# MAP

## Sample Separation



### LEGEND

-  Line path
  -  Flag Separation
- Data exceeding max. data spacing: 1.4%

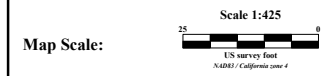



Client:	
Project: Fort Ord- Parker Flats	
Contractor:	
Created by:	Verified by:
Date:	File: 090210-ITA_DATASEP
Page number:	Approved:

# MAP

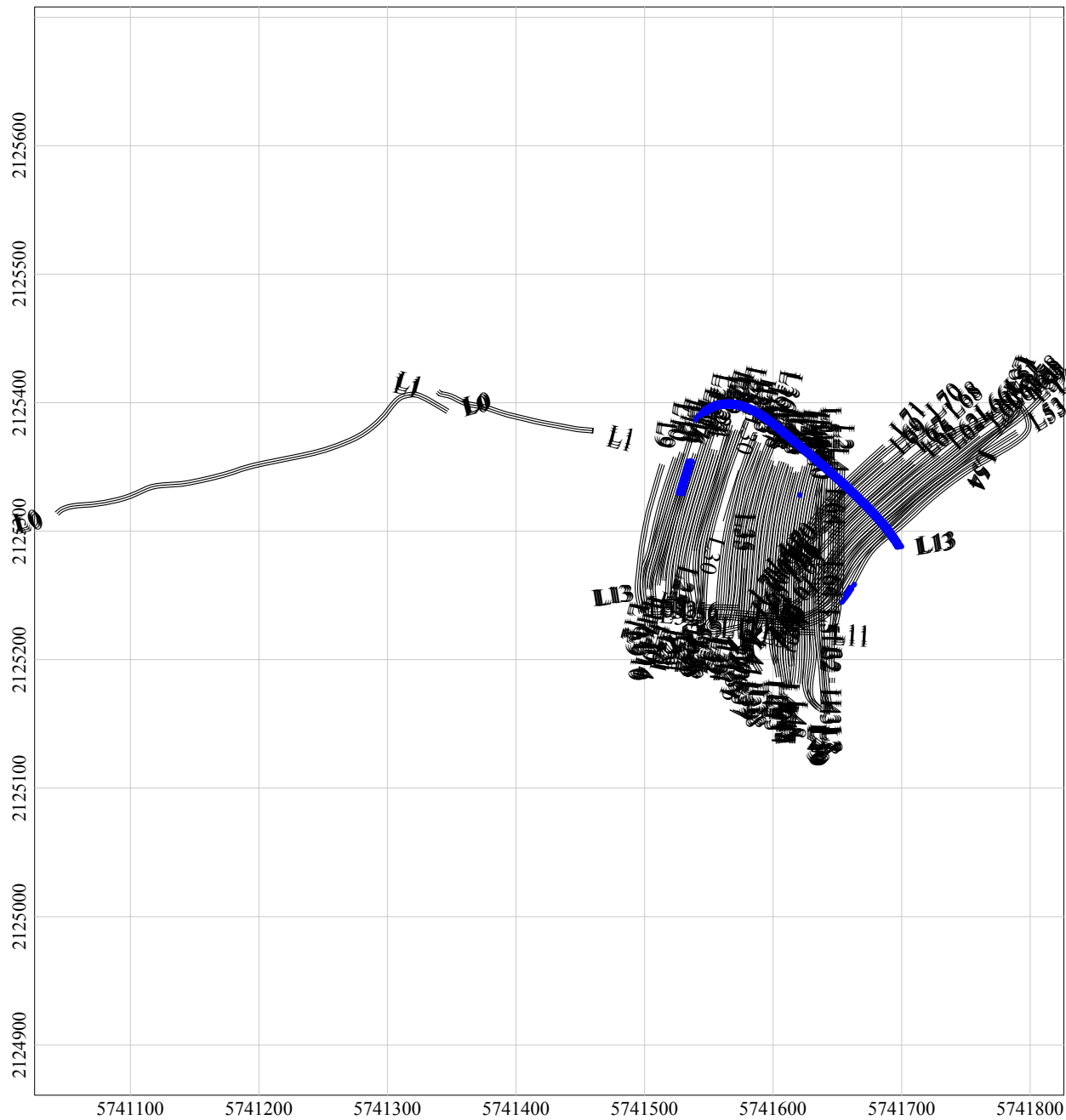
## Sample Separation



### LEGEND

-  Line path
  -  Flag Separation
- Data exceeding max. data spacing: 0.8%





Client:	
Project: Fort Ord- Parker Flats	
Contractor:	
Created by:	Verified by:
Date:	File: 090210-2TA_DATASEP
Page number:	Approved:

# MAP

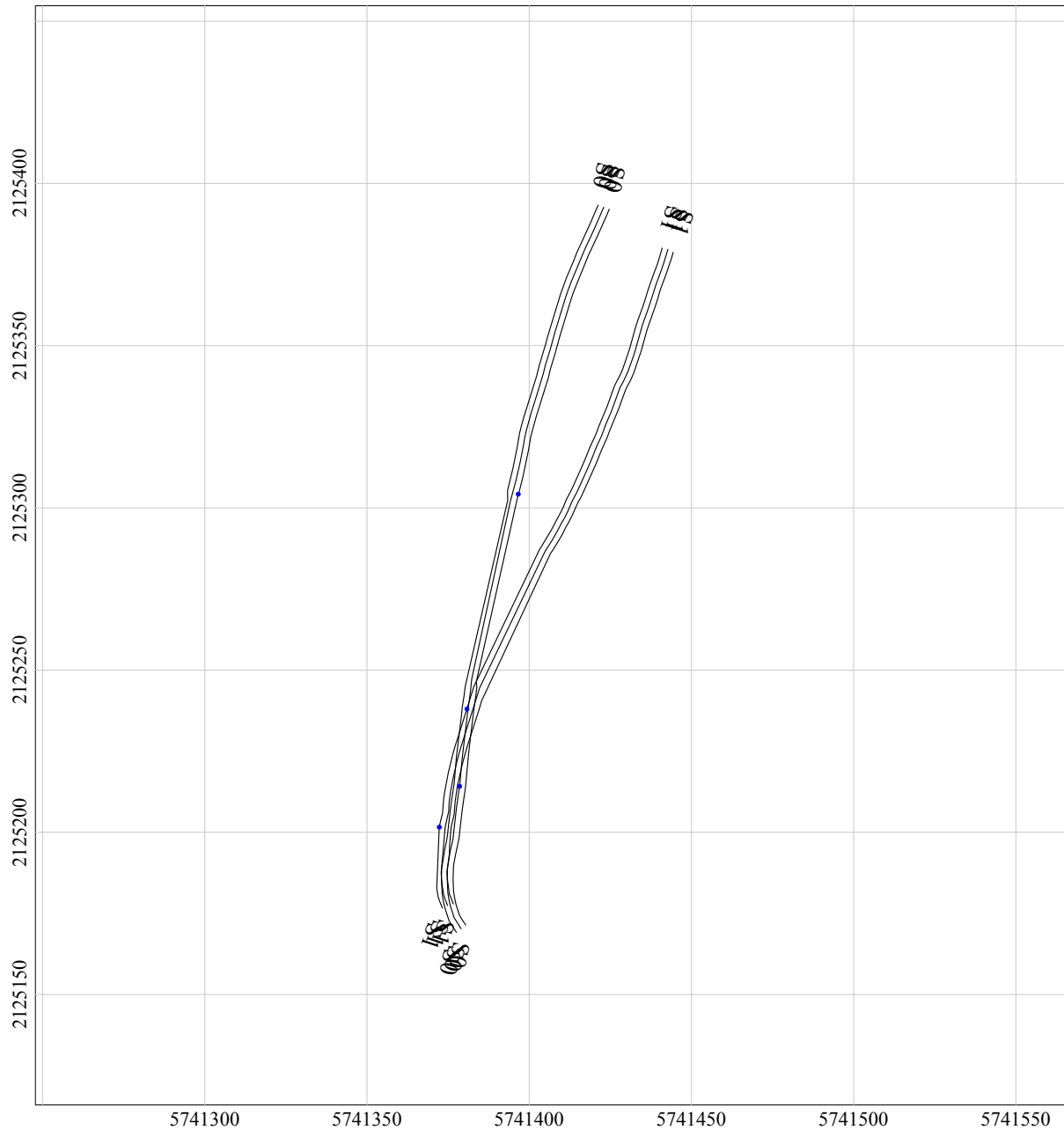
## Sample Separation



### LEGEND

-  Line path
  -  Flag Separation
- Data exceeding max. data spacing: 0.1%



<b>Client:</b>	
<b>Project: Fort Ord- Parker Flats</b>	
<b>Contractor:</b>	
<b>Created by:</b>	<b>Verified by:</b>
<b>Date:</b>	<b>File: 090710-2TA_DATASEP</b>
<b>Page number:</b>	<b>Approved:</b>

# MAP

## Sample Separation

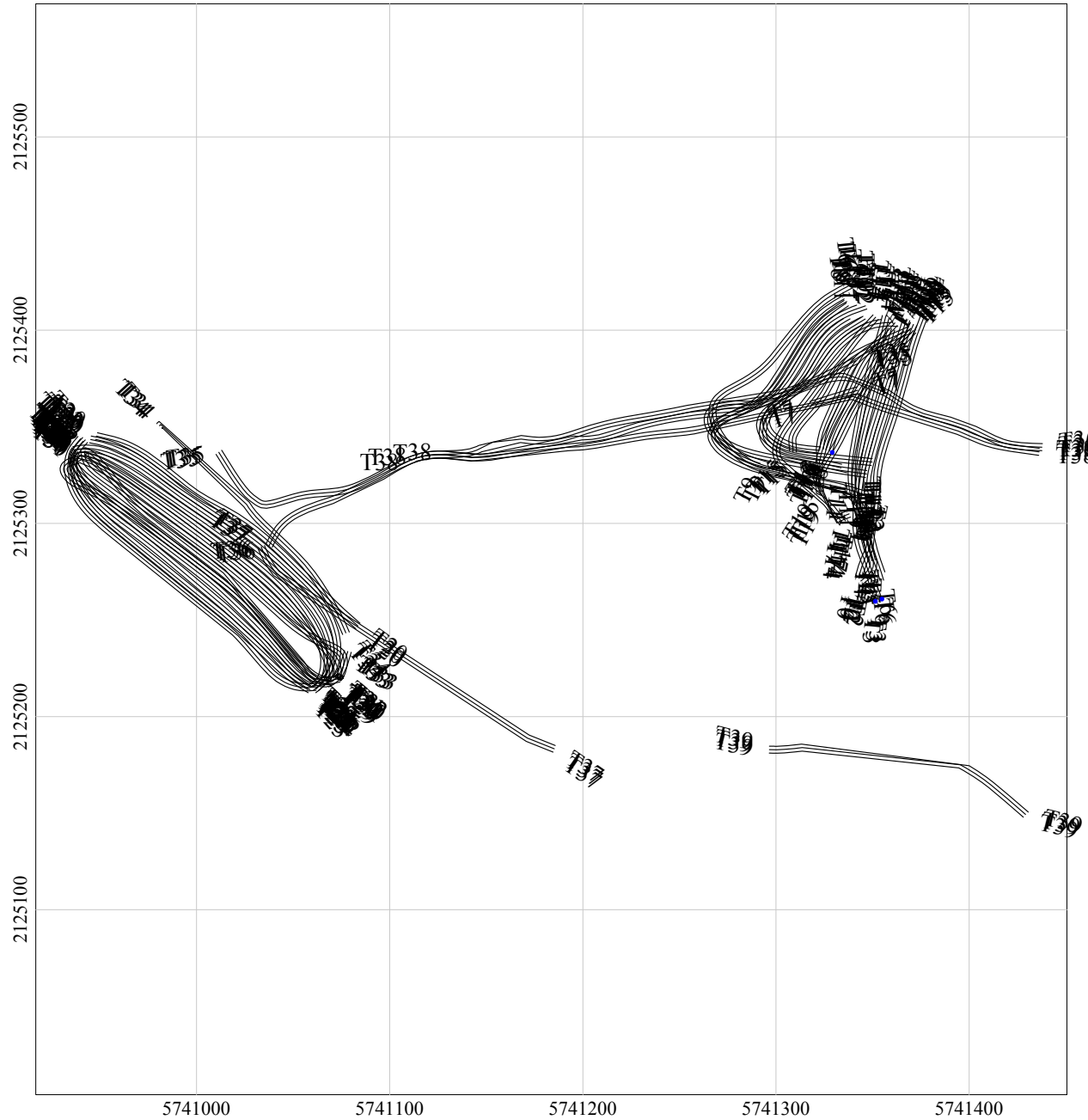

### LEGEND

- Line path
  - Flag\_Separation
- Data exceeding max. data spacing: 0.0%





<b>Client:</b>	
<b>Project: Fort Ord- Parker Flats</b>	
<b>Contractor:</b>	
<b>Created by:</b>	<b>Verified by:</b>
<b>Date:</b>	<b>File: 090710-3TA_DATASEP</b>
<b>Page number:</b>	<b>Approved:</b>

# MAP

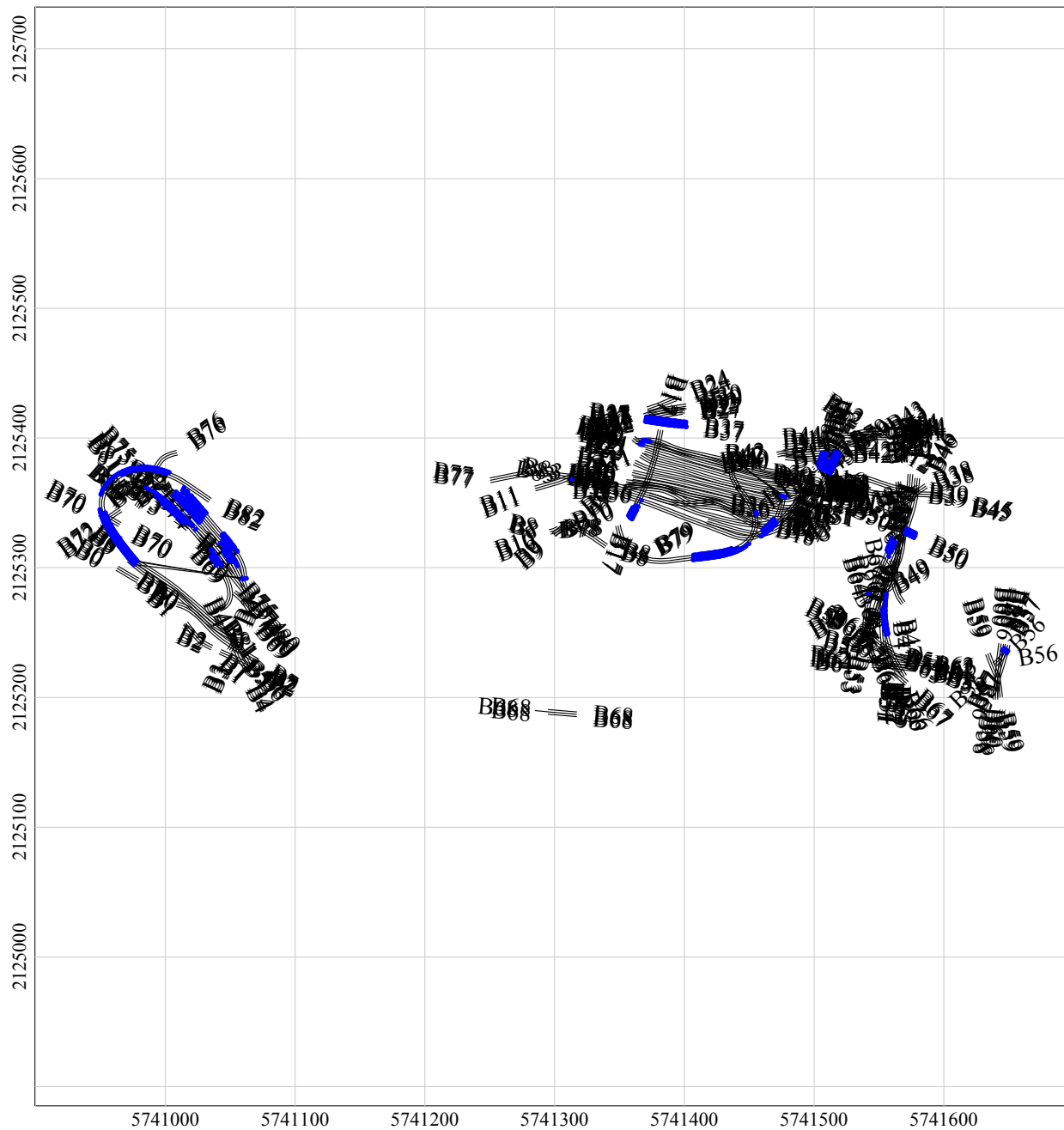
## Sample Separation



### LEGEND

-  Line path
  -  Flag Separation
- Data exceeding max. data spacing: 2.0%



Client:	
Project:	
Contractor:	
Created by:	Verified by:
Date:	File: 092210-2TA_DATASEP
Page number:	Approved:

# MAP

## Sample Separation

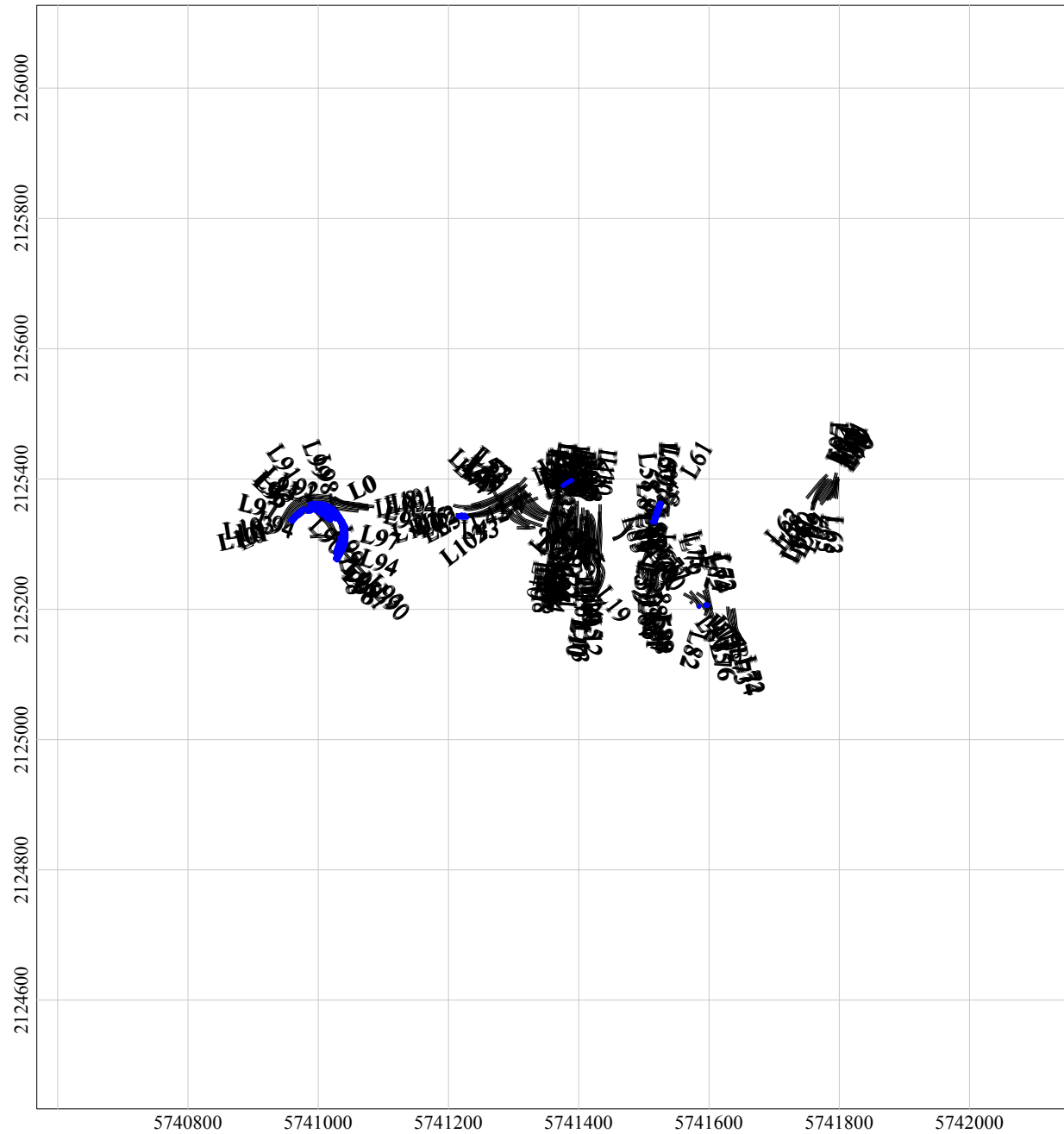

### LEGEND

- Line path
  - Flag\_Separation
- Data exceeding max. data spacing: 1.5%





<b>Client:</b>	
<b>Project: Fort Ord- Parker Flats</b>	
<b>Contractor:</b>	
<b>Created by:</b>	<b>Verified by:</b>
<b>Date:</b>	<b>File: 092910-2TA_DATASEP</b>
<b>Page number:</b>	<b>Approved:</b>

# MAP

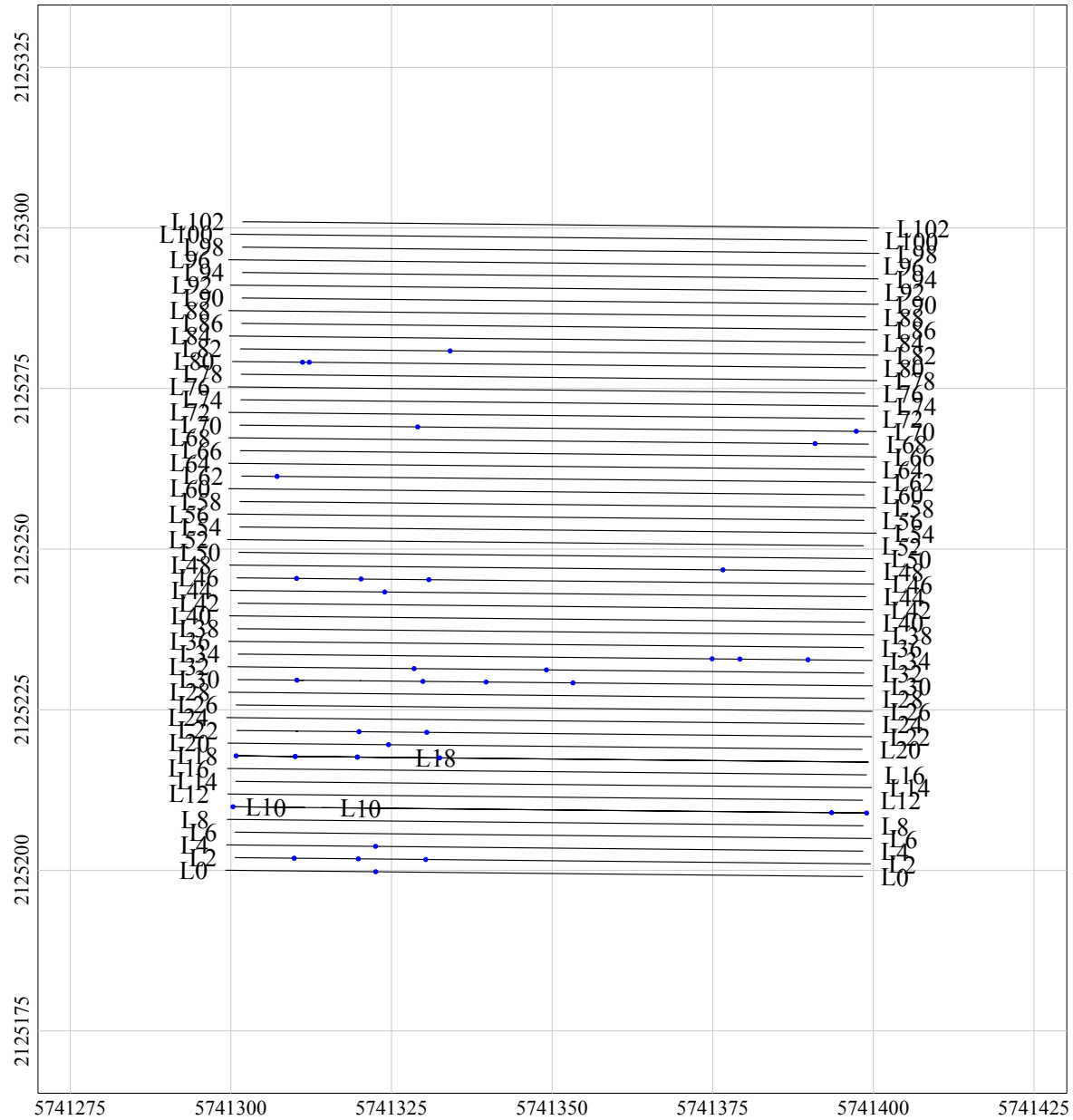
## Sample Separation



### LEGEND

-  Line path
  -  Flag Separation
- Data exceeding max. data spacing: 0.1%





Client:	
Project:	
Contractor:	
Created by:	Verified by:
Date:	File: 102710-ISU_DATASEP
Page number:	Approved:

# MAP

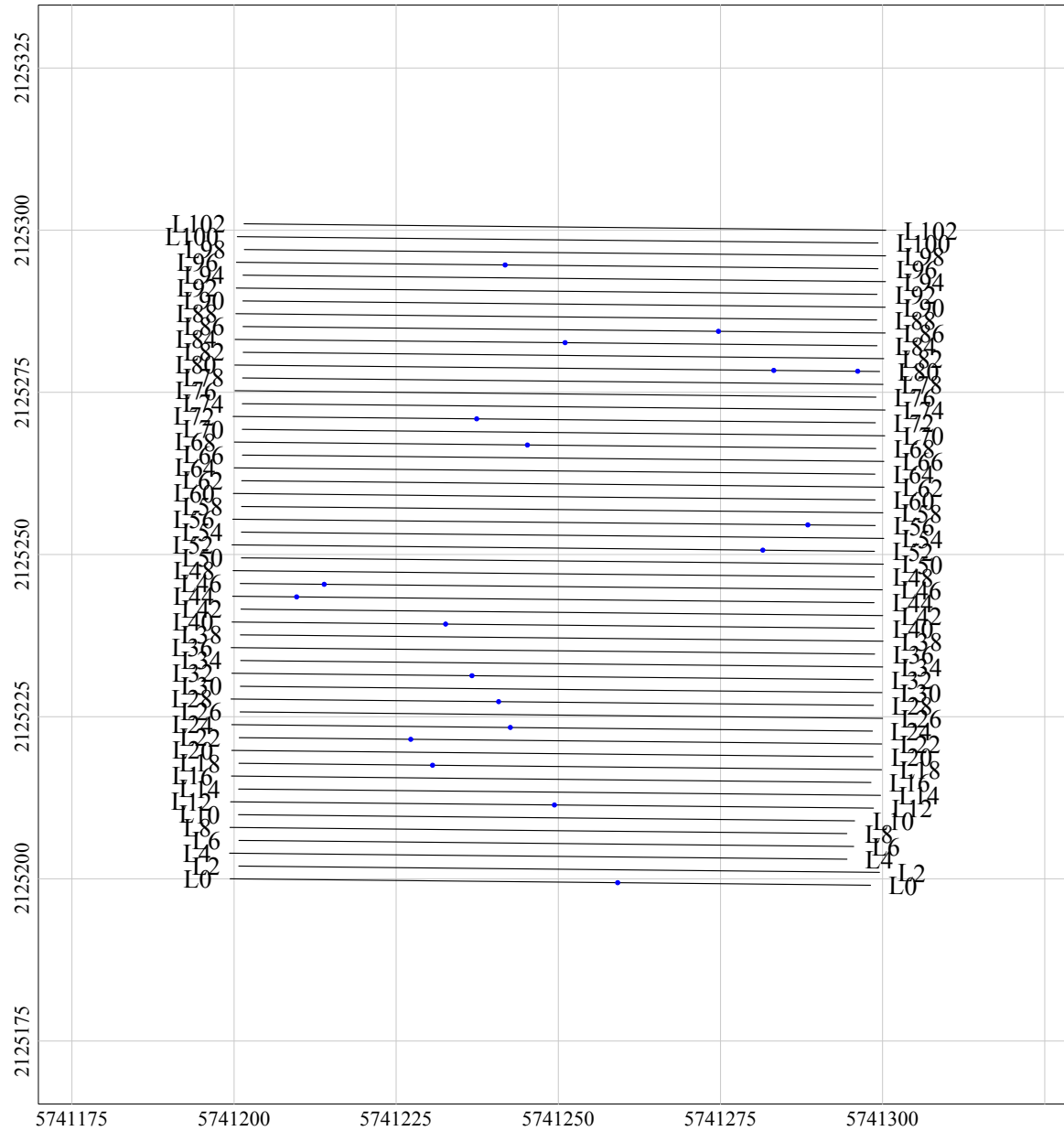
## Sample Separation



### LEGEND

-  Line path
  -  Flag Separation
- Data exceeding max. data spacing: 0.1%

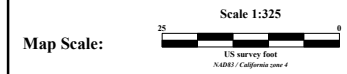

Client:

Project:

Contractor:

Created by:

Verified by:

Date:

File: 110110-ISU\_DATASEP

Page number:

Approved:



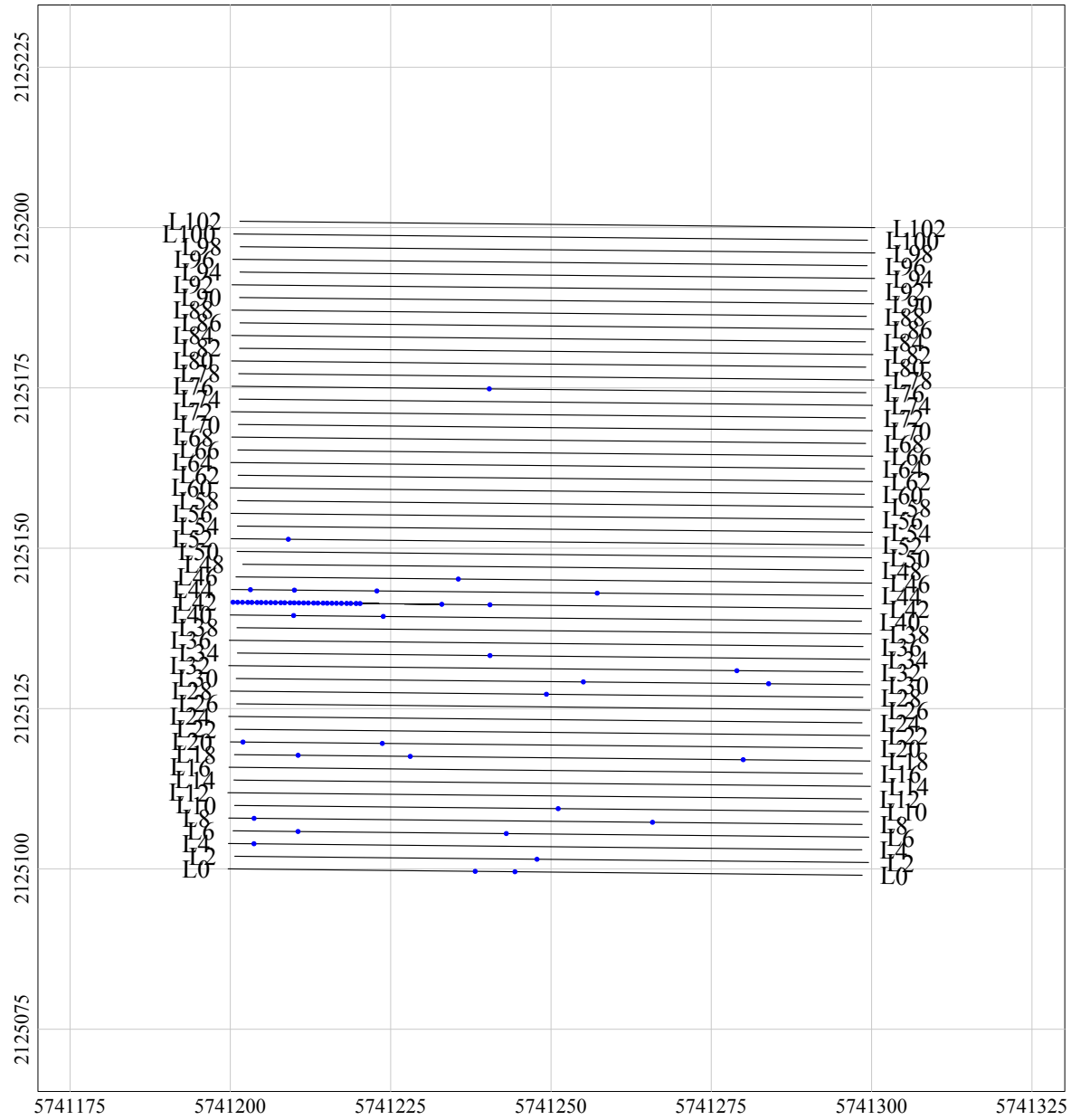

# MAP

## Sample Separation



### LEGEND

-  Line path
  -  Flag Separation
- Data exceeding max. data spacing: 0.2%



Client:

Project:

Contractor:

Created by:

Verified by:

Date:

File: 110110-2SU\_DATASEP

Page number:

Approved:

# MAP

## Sample Separation

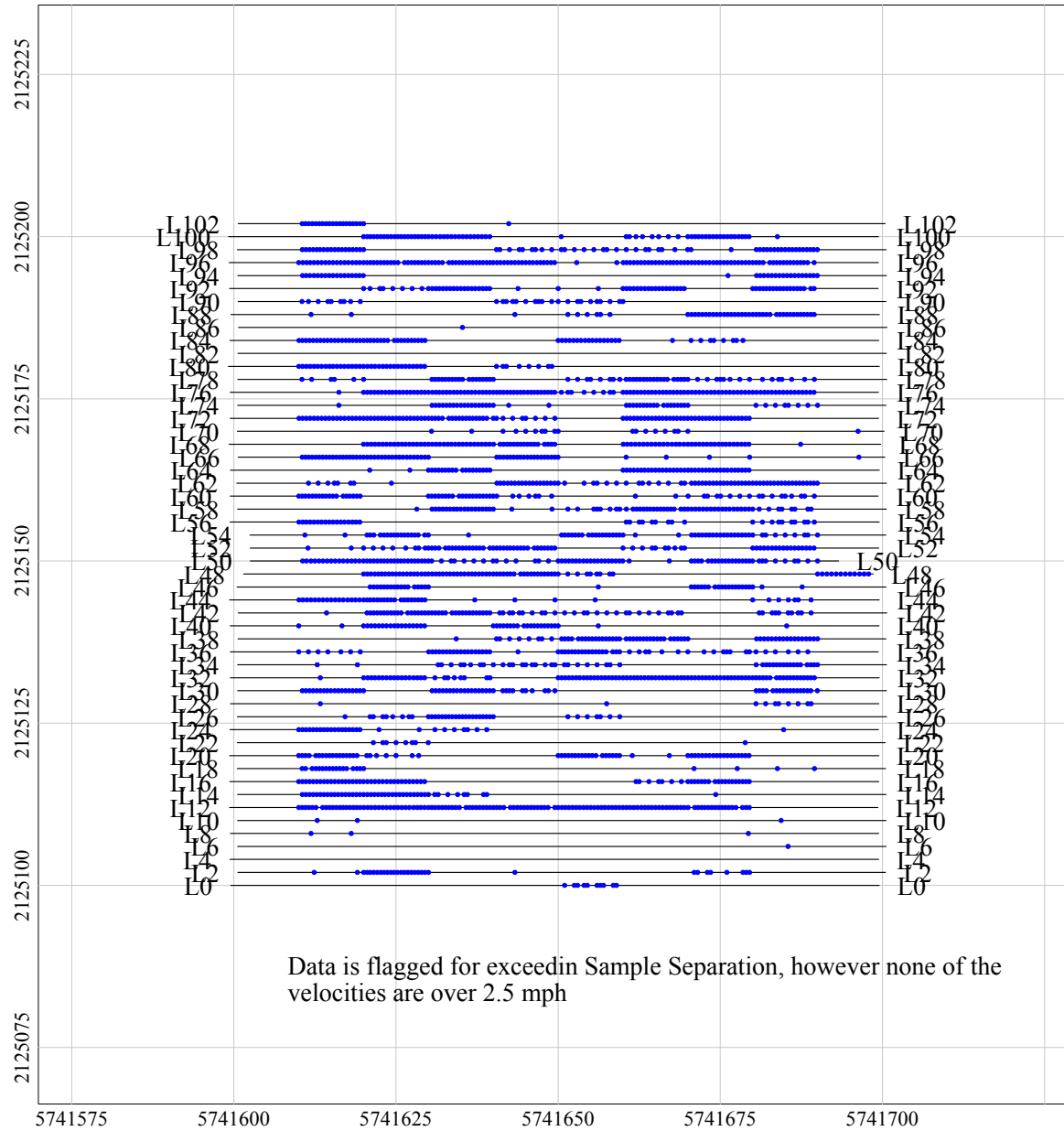

### LEGEND

- Line path
  - Flag Separation
- Data exceeding max. data spacing: 20.8%

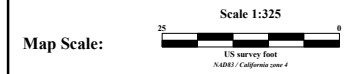

<b>Client:</b>	
<b>Project:</b>	
<b>Contractor:</b>	
<b>Created by:</b>	<b>Verified by:</b>
<b>Date:</b>	<b>File: 110310-ISU_DATASEP</b>
<b>Page number:</b>	<b>Approved:</b>

# MAP

## Sample Separation

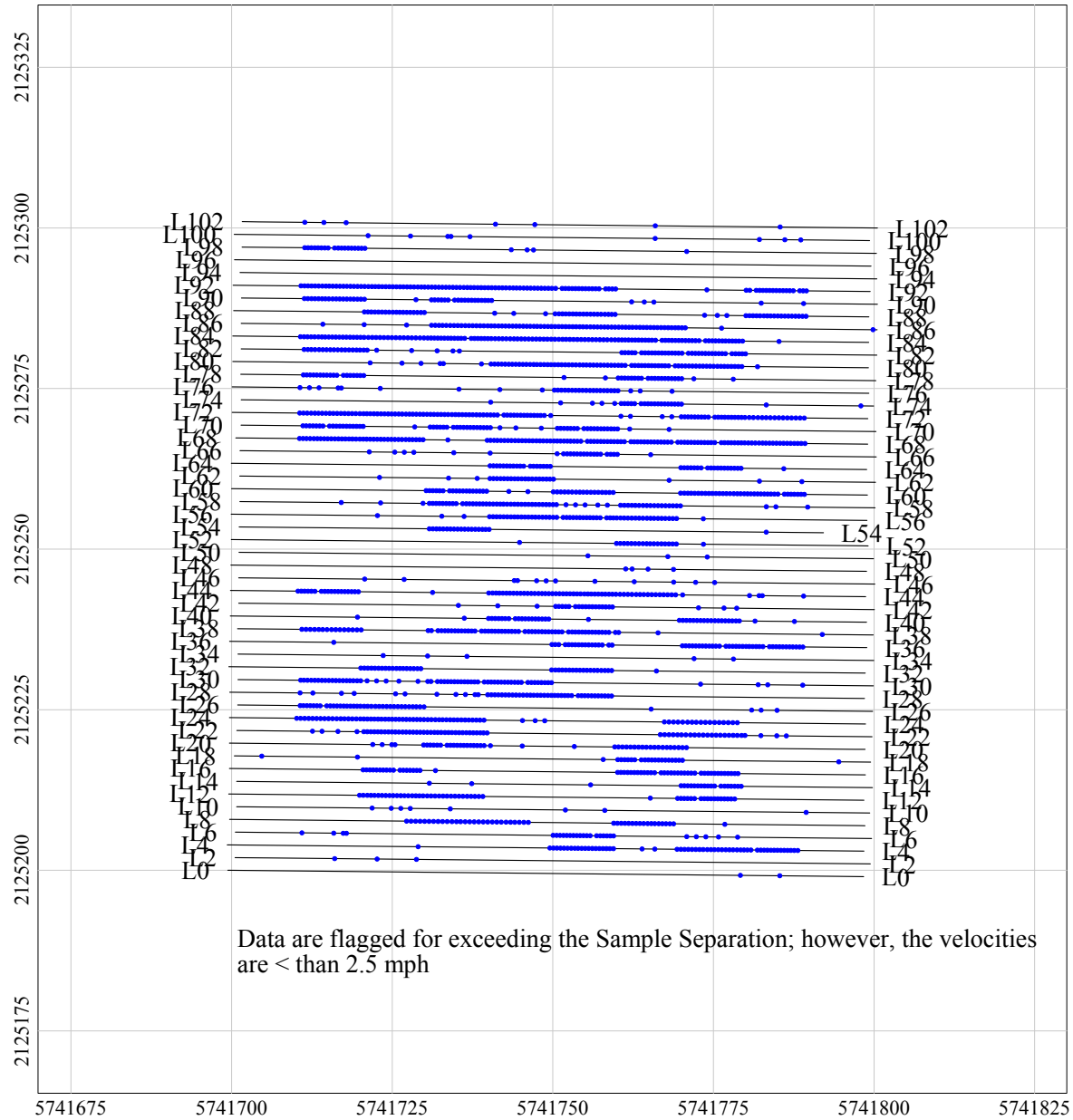

### LEGEND

- Line path
  - Flag Separation
- Data exceeding max. data spacing: 17.4%





Client:	
Project:	
Contractor:	
Created by:	Verified by:
Date:	File: 110310-2SU_DATASEP
Page number:	Approved:

# MAP

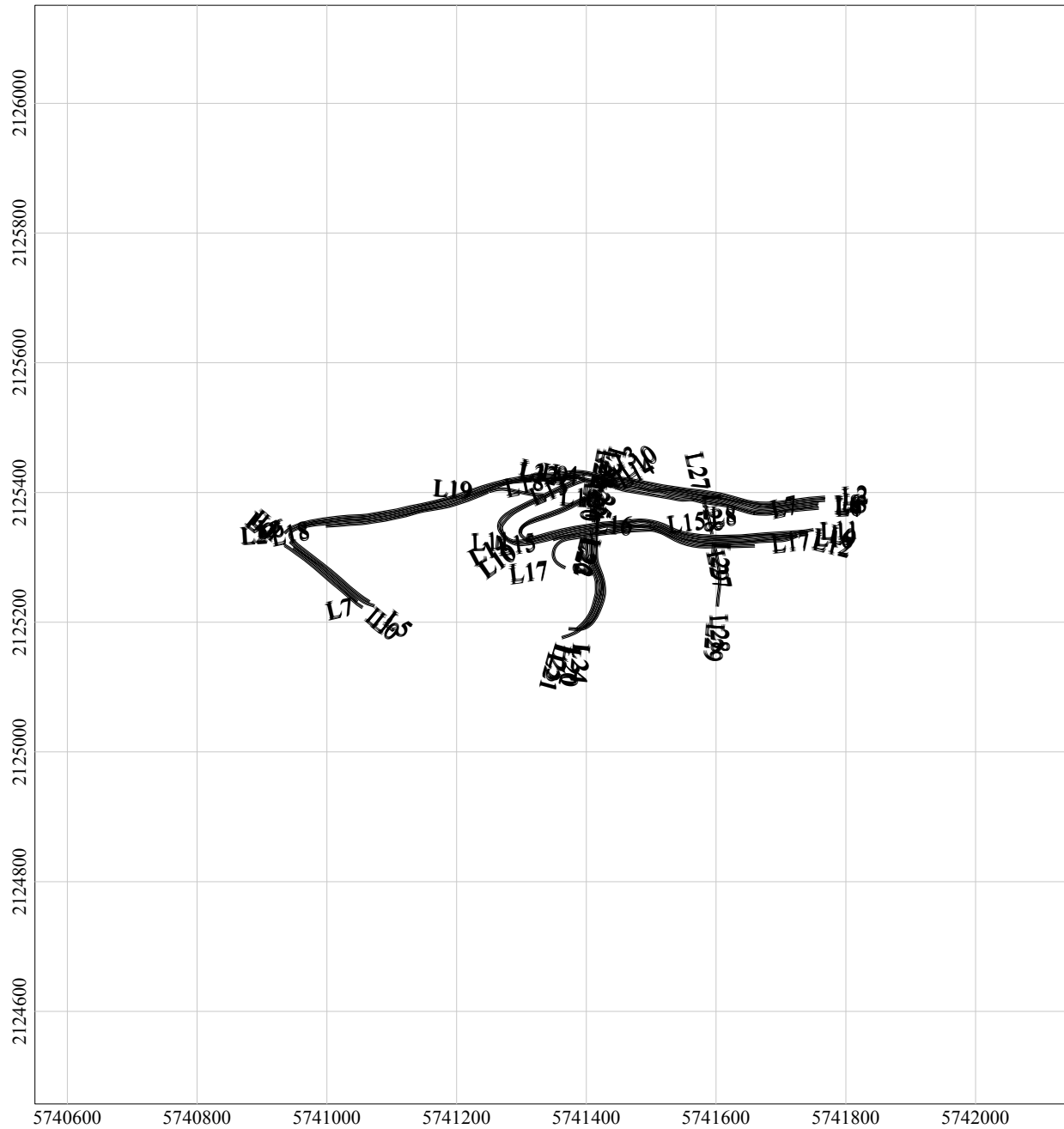
## Sample Separation



### LEGEND

-  Line path
  -  Flag Separation
- Data exceeding max. data spacing: 0.0%





Client:	
Project:	
Contractor:	
Created by:	Verified by:
Date:	File: 122110-ITA_DATASEP
Page number:	Approved:

# MAP

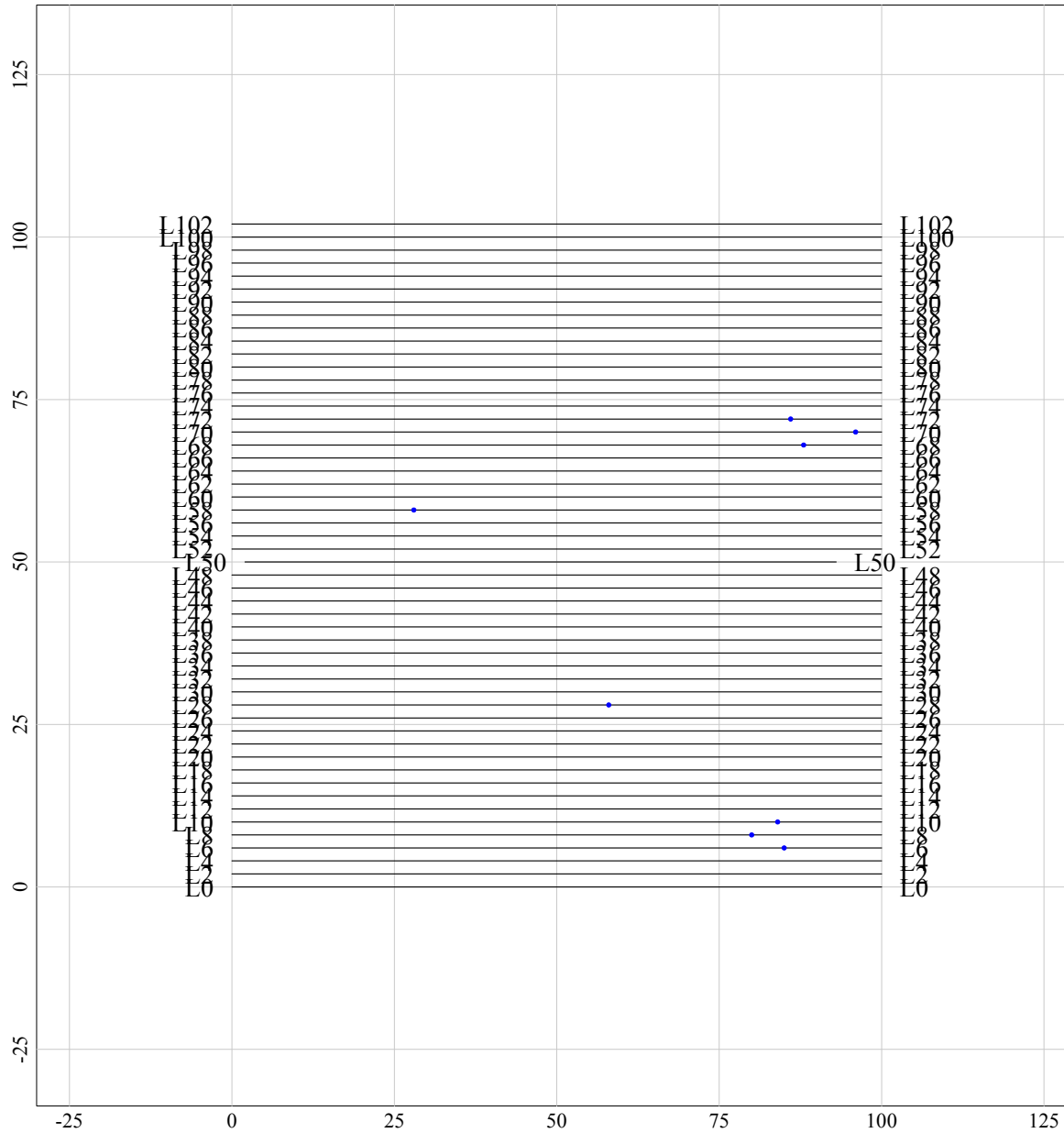
## Sample Separation



### LEGEND

-  Line path
  -  Flag Separation
- Data exceeding max. data spacing: 0.0%

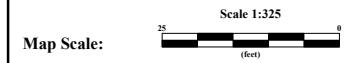

<b>Client:</b>	
<b>Project:</b>	
<b>Contractor:</b>	
<b>Created by:</b>	<b>Verified by:</b>
<b>Date:</b>	<b>File: 122310-ISU_DATASEP</b>
<b>Page number:</b>	<b>Approved:</b>