

MAP

Sample Separation

LEGEND

- Line path
 - Flag_Separation
- Data exceeding max. data spacing: 0.0%

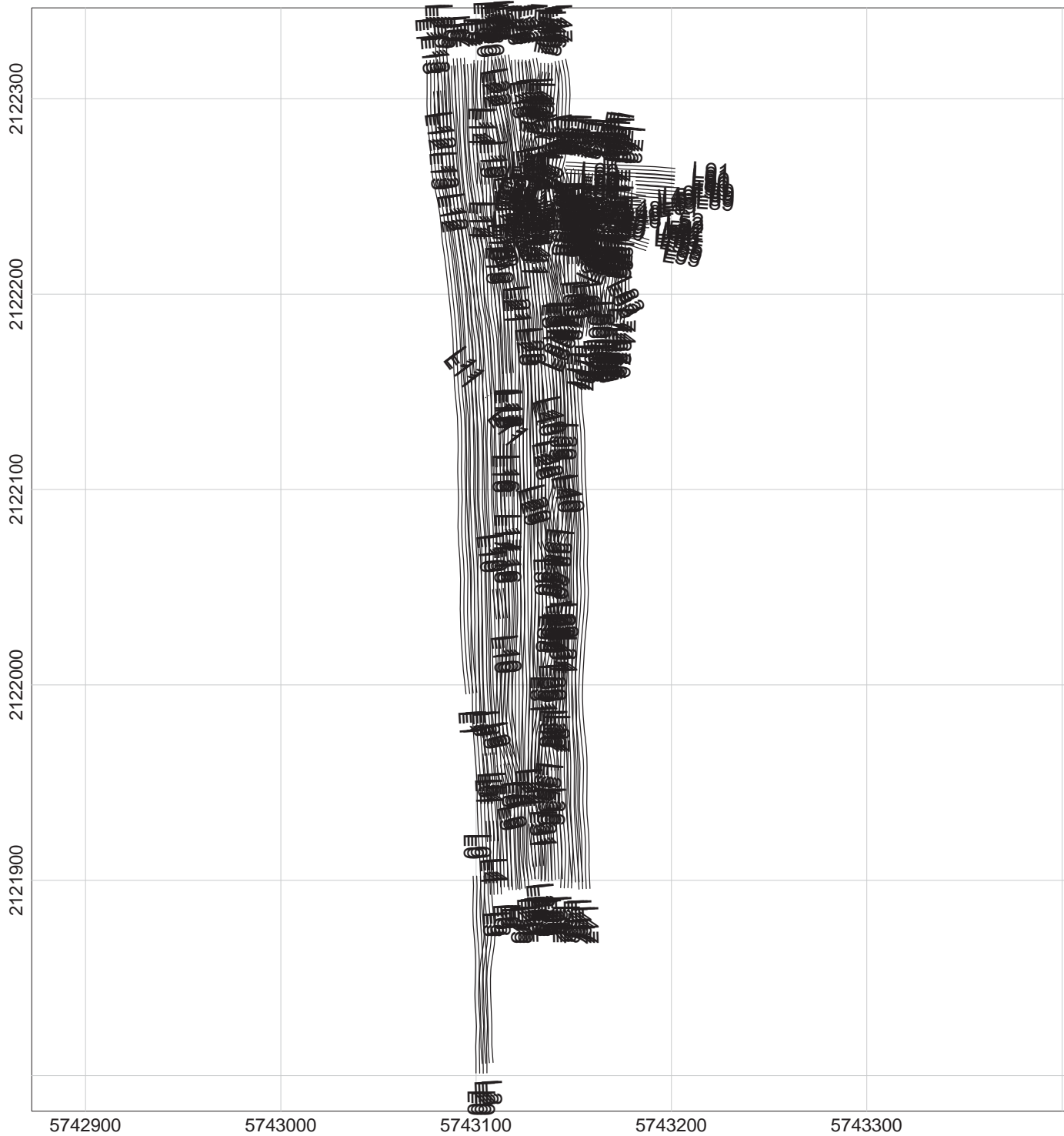

Client:

Project:

Contractor:

Created by:

Verified by:

Date:

File: 032712-1TA_DATASEP

Page number:

Approved:

MAP

Sample Separation

LEGEND

- Line path
 - Flag_Separation
- Data exceeding max. data spacing: 0.0%

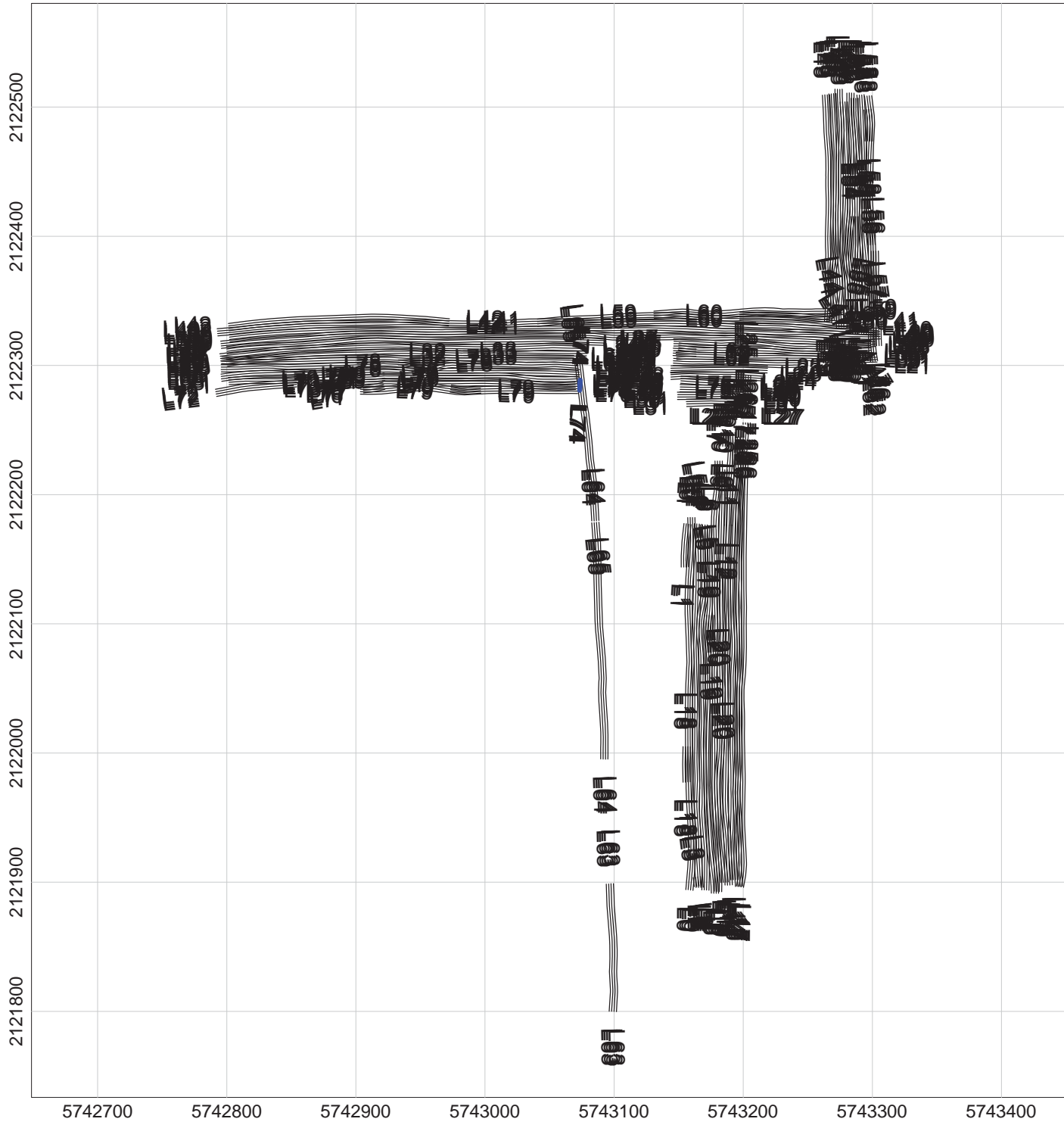

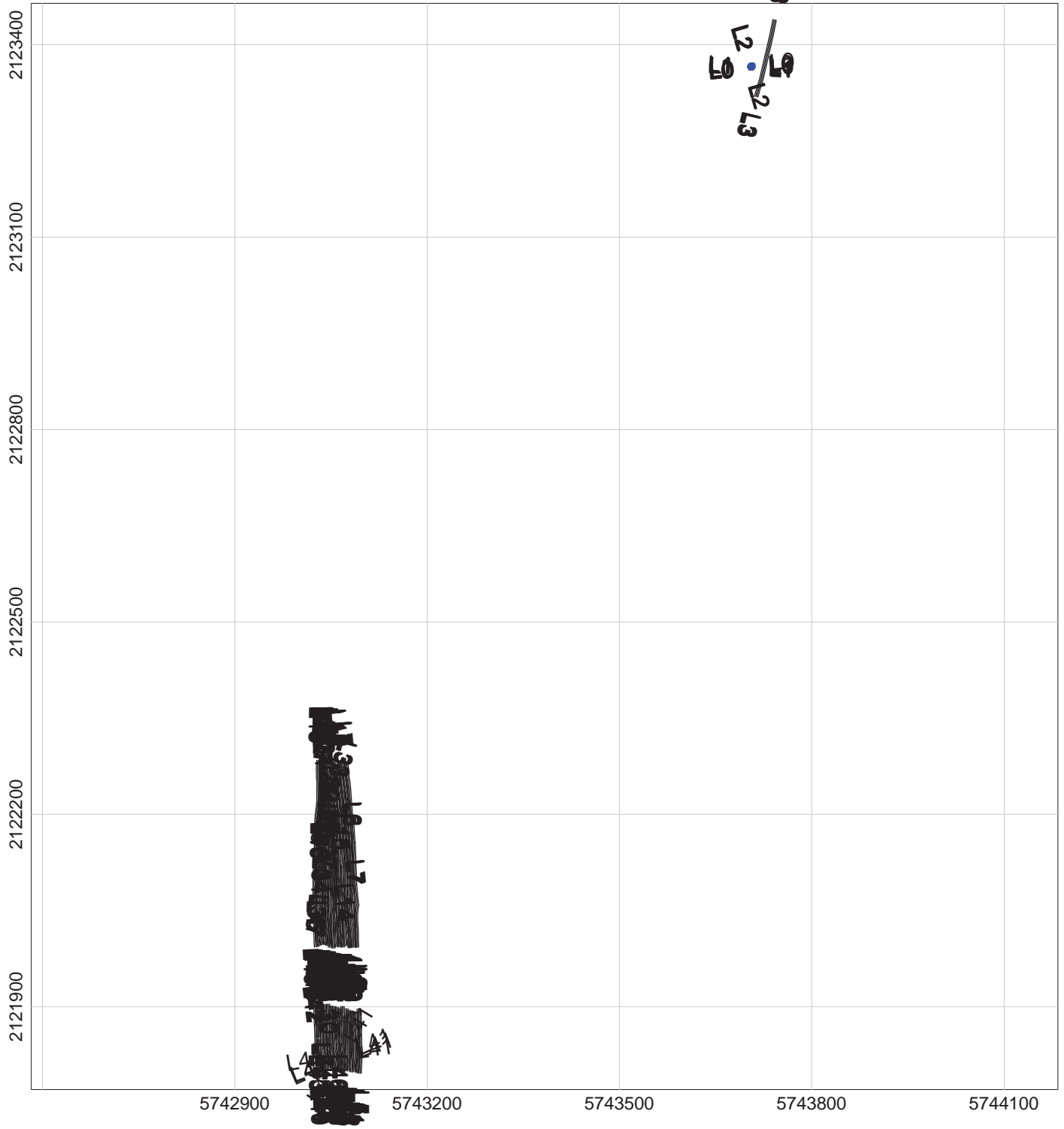

Client:	
Project:	
Contractor:	
Created by:	Verified by:
Date:	File: 032712-2TA_DATASEP
Page number:	Approved:



MAP

Sample Separation

LEGEND

-  Line path
 -  Flag_Separation
- Data exceeding max. data spacing: 1.5%



Client:	
Project:	
Contractor:	
Created by:	Verified by:
Date:	File: 032812-1ATA_DATASEP
Page number:	Approved:

MAP

Sample Separation

LEGEND

- Line path
 - Flag_Separation
- Data exceeding max. data spacing: 0.9%

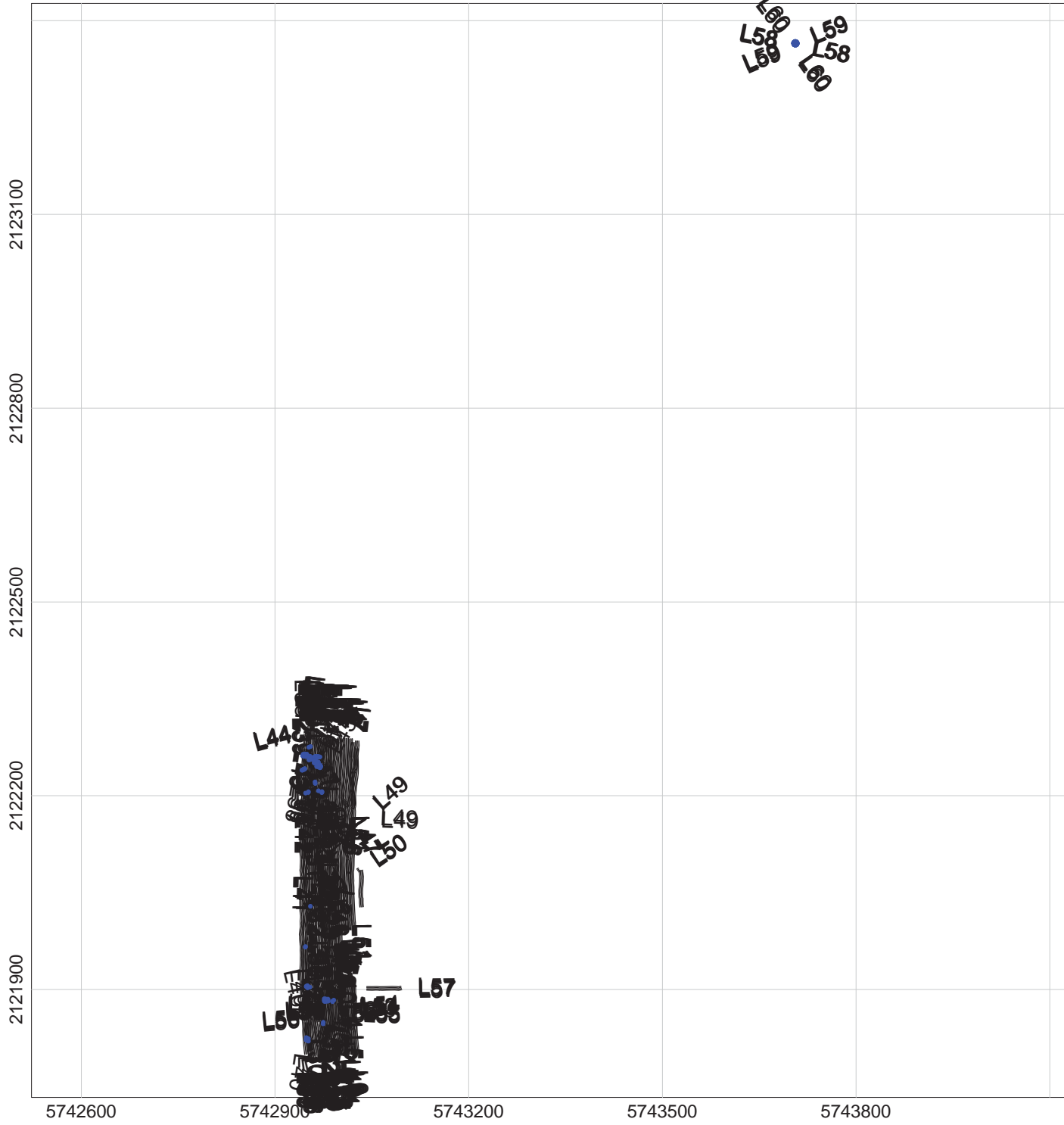

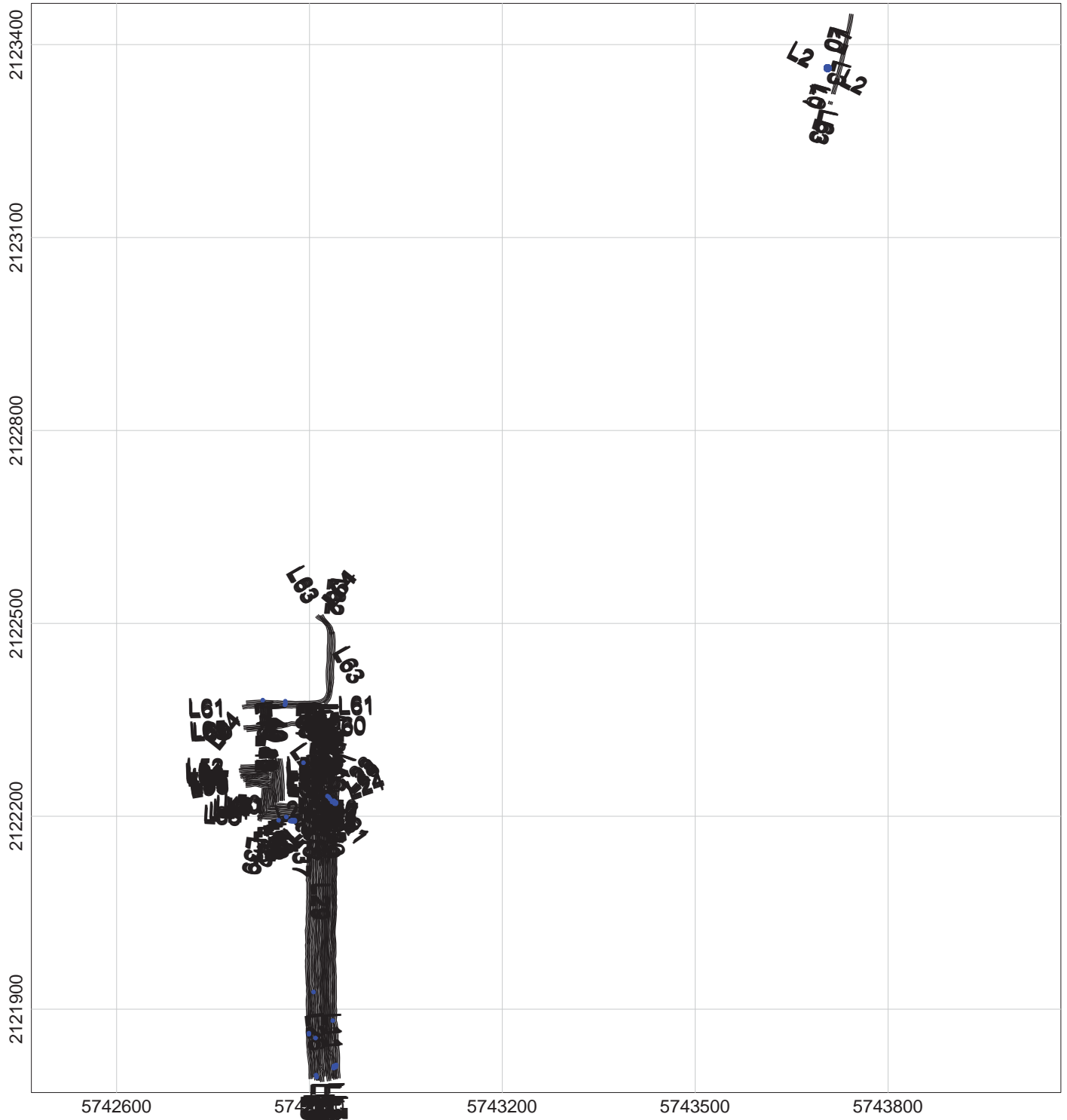

Client:	
Project:	
Contractor:	
Created by:	Verified by:
Date:	File: 032812-1TA_DATASEP
Page number:	Approved:



MAP

Sample Separation

LEGEND

-  Line path
 -  Flag_Separation
- Data exceeding max. data spacing: 1.9%



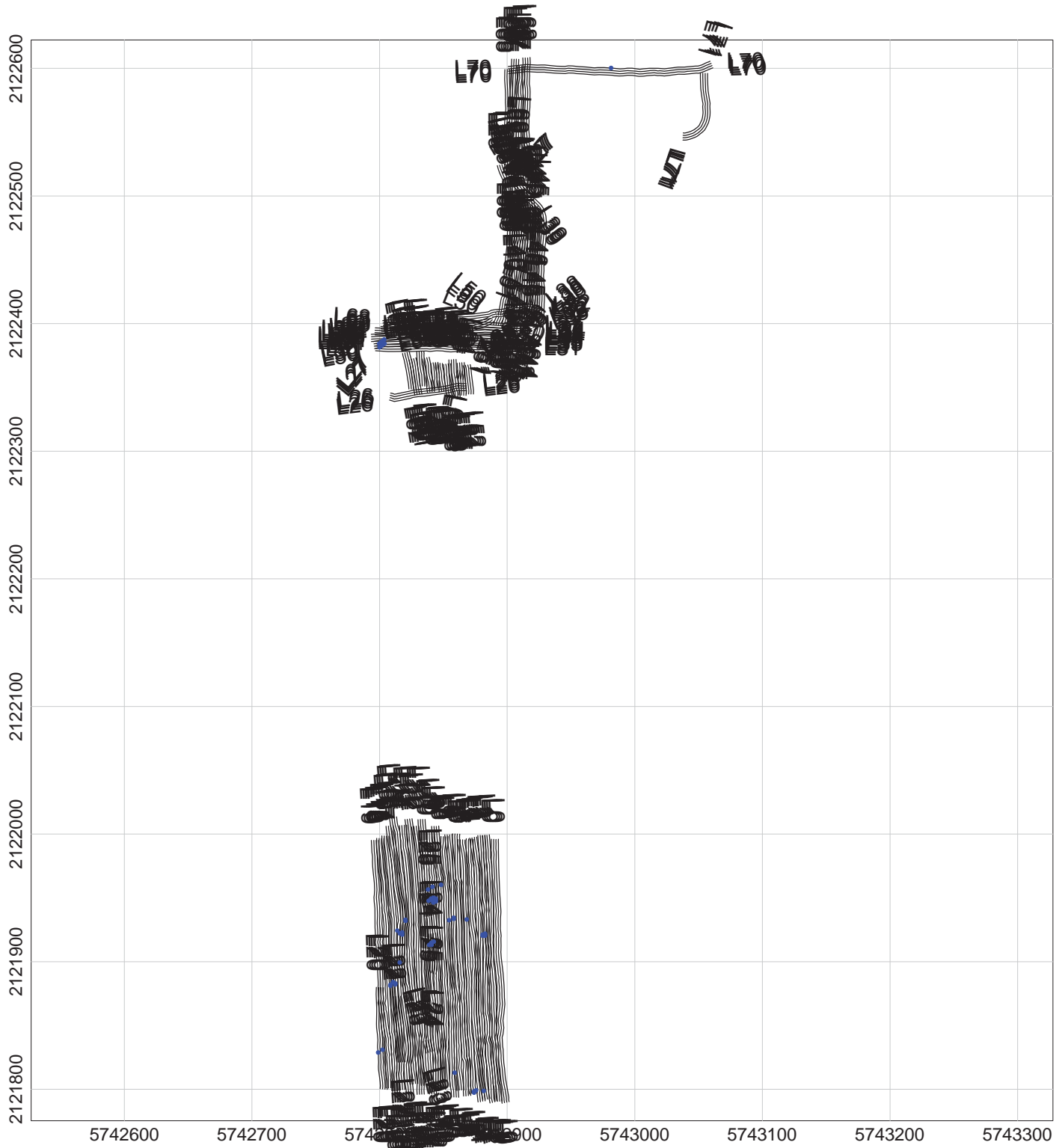

Client:	
Project:	
Contractor:	
Created by:	Verified by:
Date:	File: 032912-1ATA_DATASEP
Page number:	Approved:



MAP

Sample Separation

LEGEND

-  Line path
 -  Flag_Separation
- Data exceeding max. data spacing: 0.1%





Client:	
Project:	
Contractor:	
Created by:	Verified by:
Date:	File: 032912-1TA_DATASEP
Page number:	Approved:

MAP

Sample Separation

LEGEND

-  Line path
-  Flag_Separation

Data exceeding max. data spacing: 0.0%

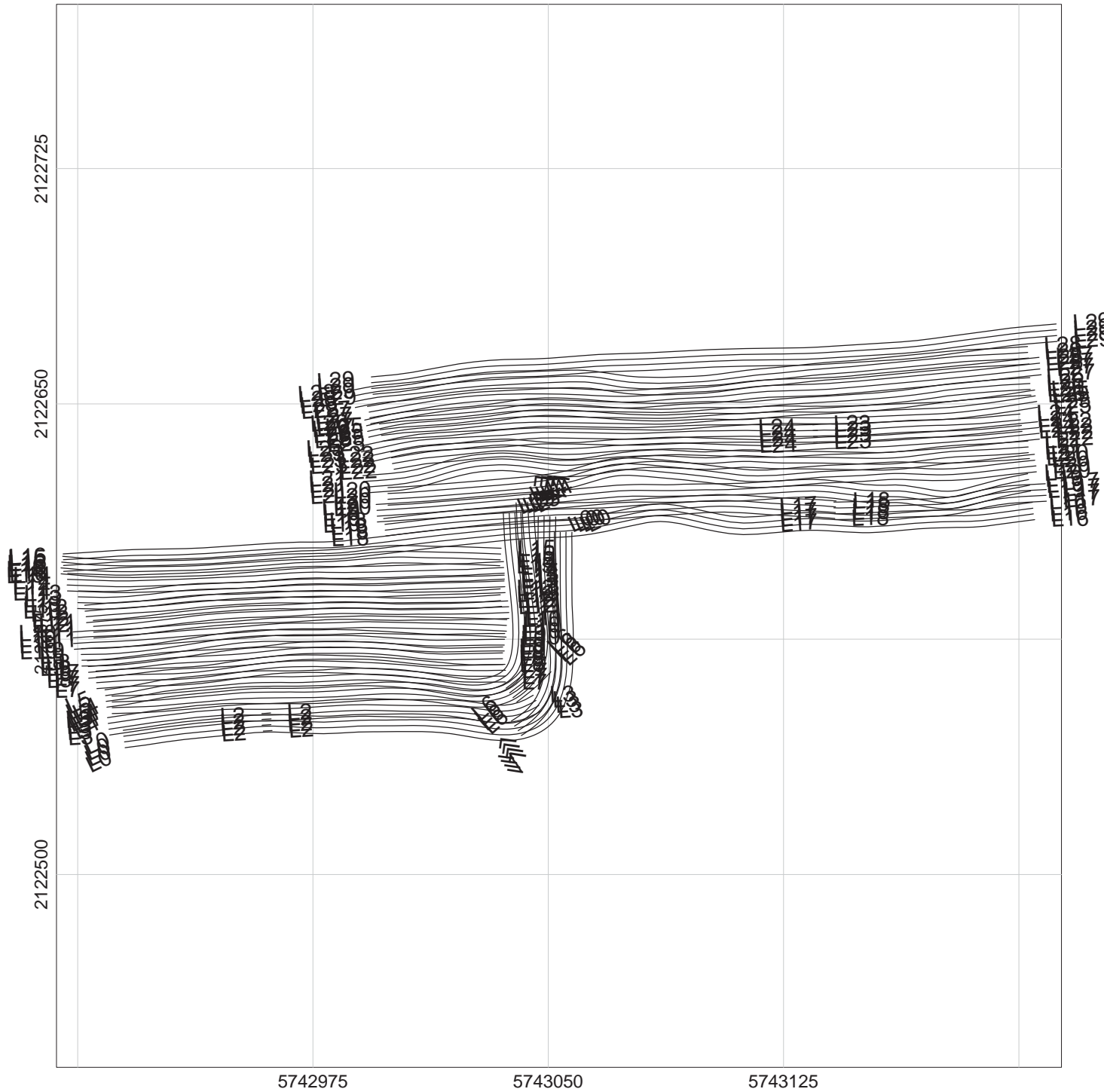

Client:	
Project:	
Contractor:	
Created by:	Verified by:
Date:	File: 040312-1TA_DATASEP
Page number:	Approved:

MAP

Sample Separation

LEGEND

- Line path
 - Flag_Separation
- Data exceeding max. data spacing: 0.1%

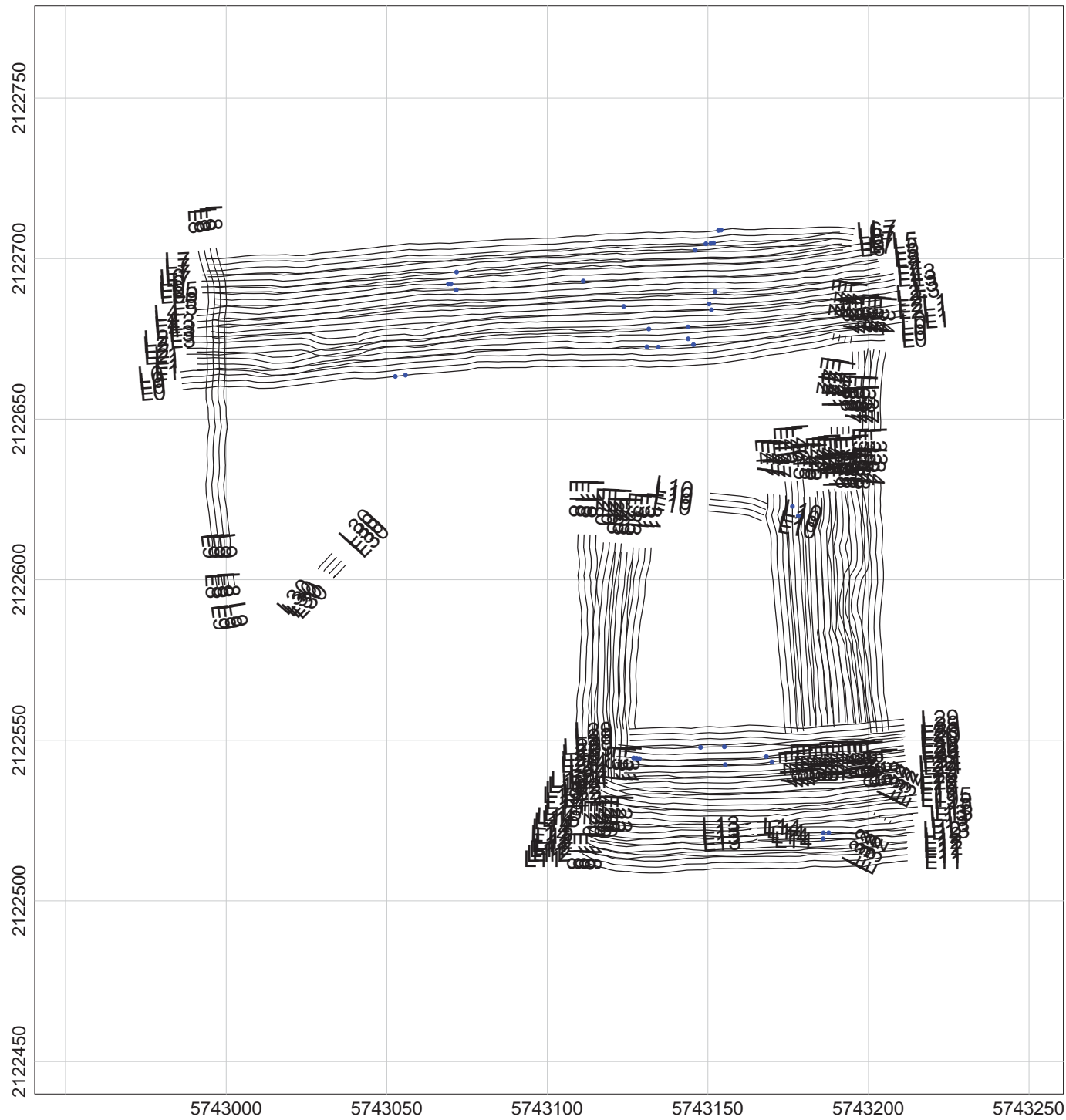

Client:	
Project:	
Contractor:	
Created by:	Verified by:
Date:	File: 040312-2TA_DATASEP
Page number:	Approved:

MAP

Sample Separation

LEGEND

- Line path
 - Flag_Separation
- Data exceeding max. data spacing: 0.0%

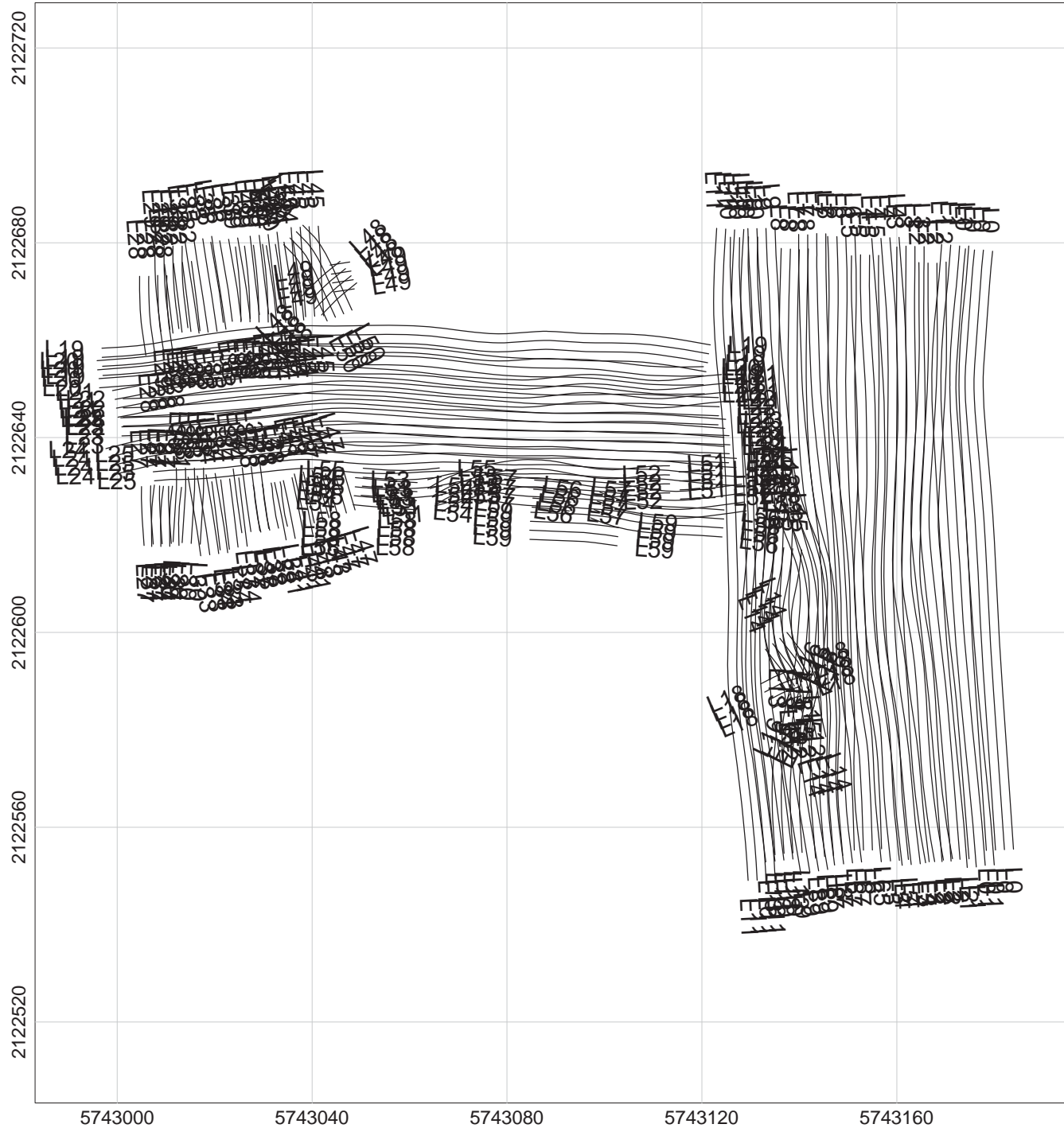

Client:	
Project:	
Contractor:	
Created by:	Verified by:
Date:	File: 040412-1TA_DATASEP
Page number:	Approved:

MAP

Sample Separation

LEGEND

- Line path
 - Flag_Separation
- Data exceeding max. data spacing: 0.0%

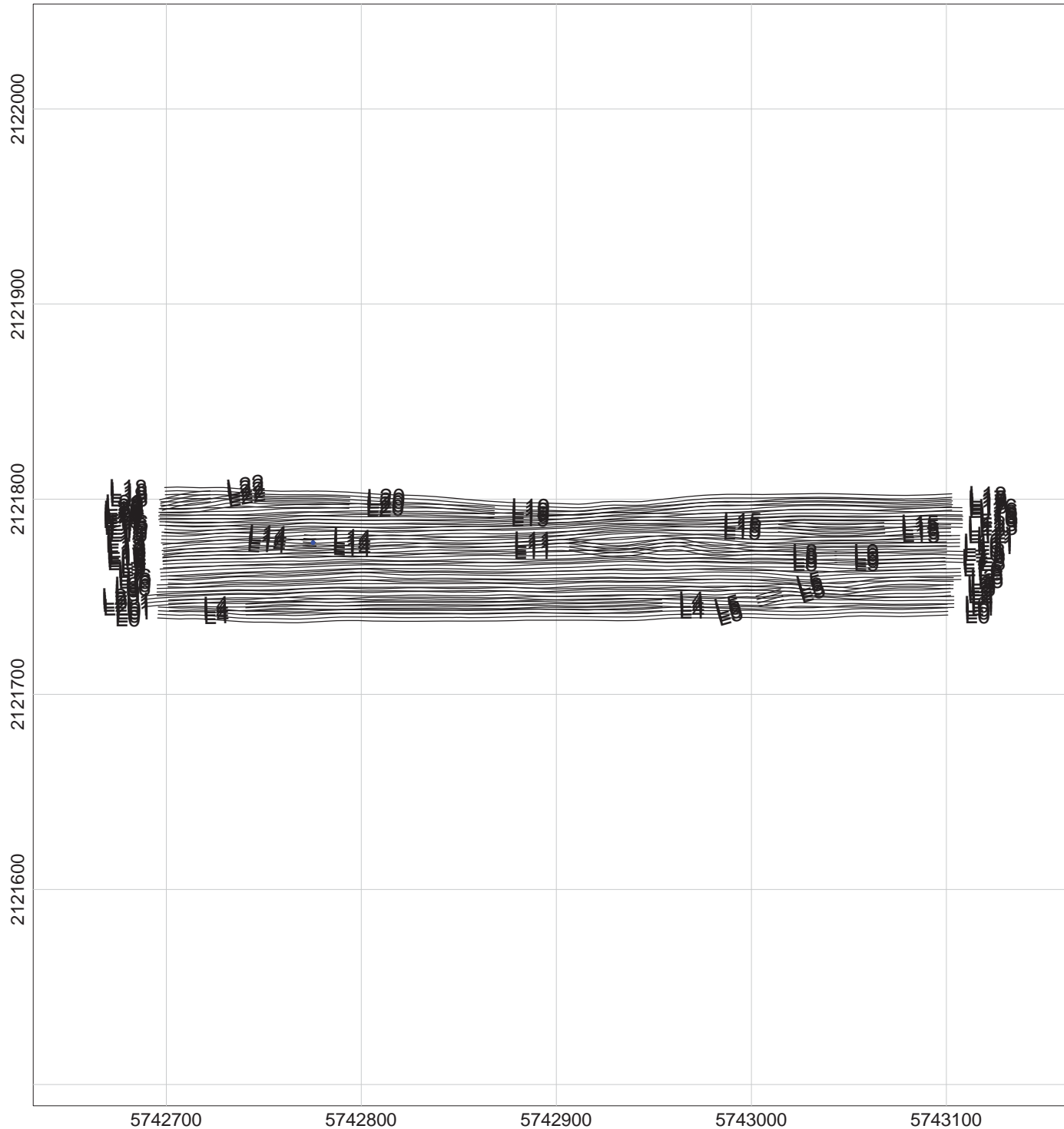

Client:	
Project:	
Contractor:	
Created by:	Verified by:
Date:	File: 040512-1TA_DATASEP
Page number:	Approved:

MAP

Sample Separation

LEGEND

- Line path
 - Flag_Separation
- Data exceeding max. data spacing: 0.0%

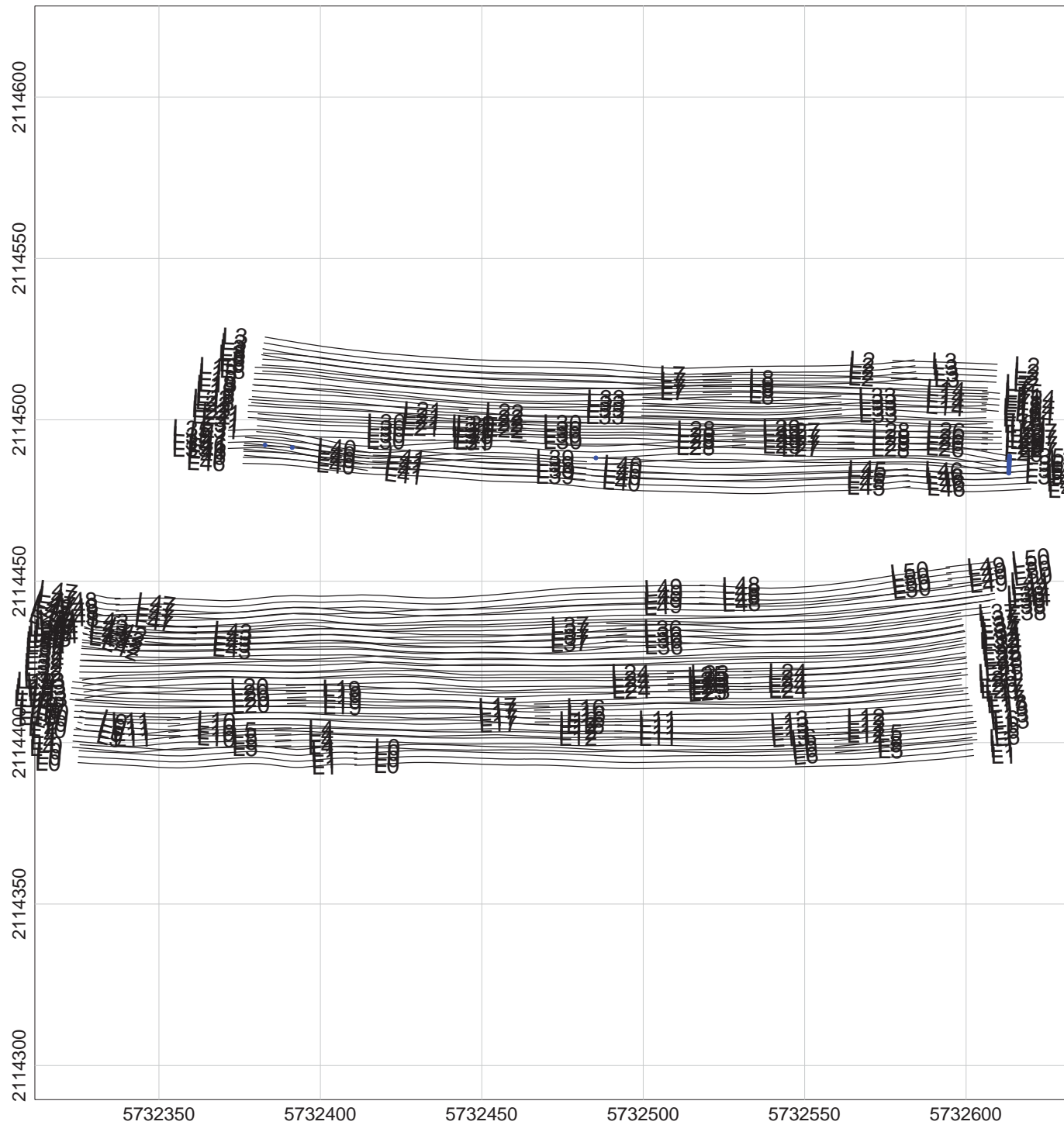

Client:	
Project:	
Contractor:	
Created by:	Verified by:
Date:	File: 040512-2TA_DATASEP
Page number:	Approved:

MAP

Sample Separation

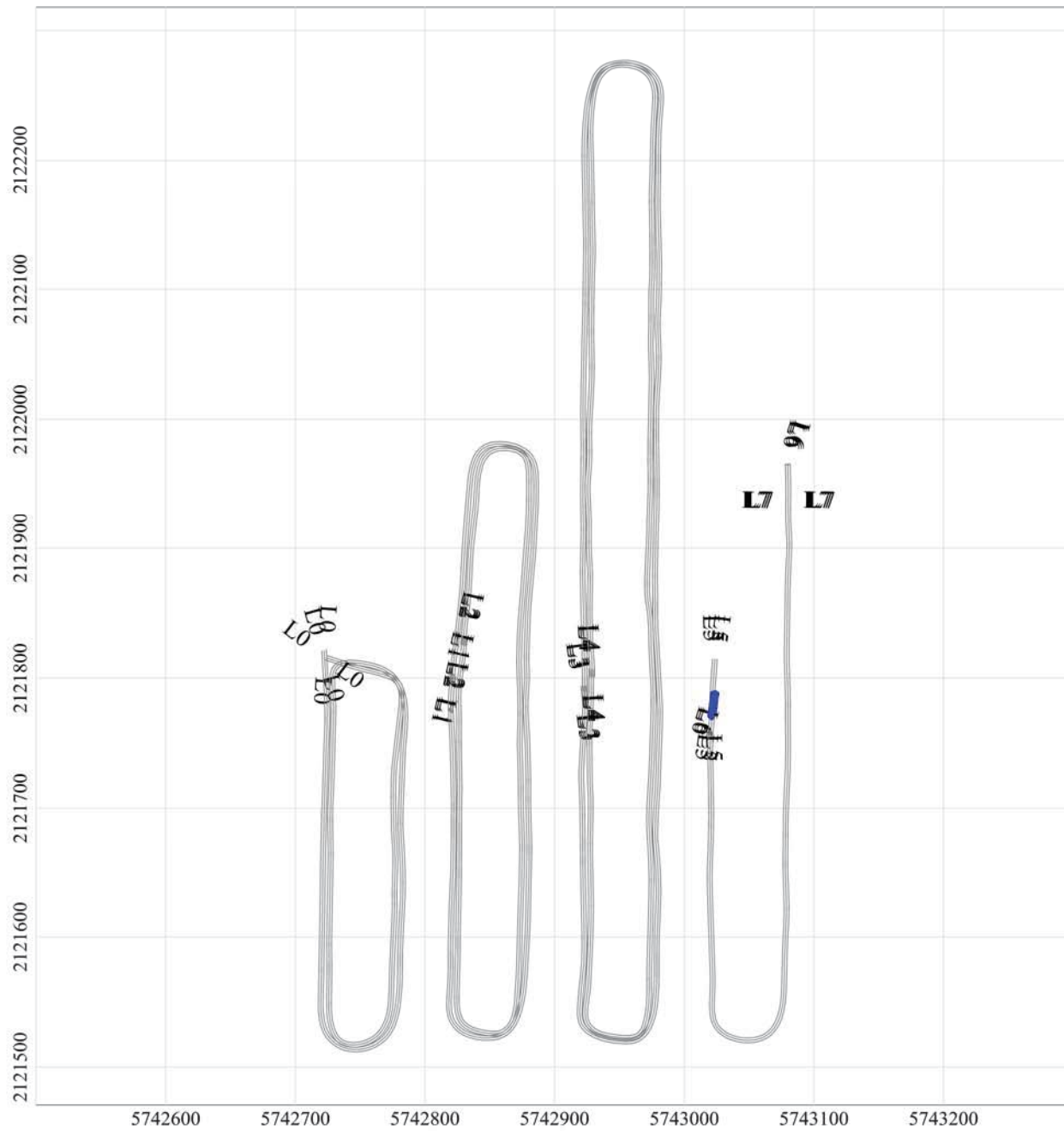

LEGEND

- Line path
 - Flag Separation
- Data exceeding max. data spacing: 0.1%

 Grid North: 0°0'0"
 Mag North: 0°0'0"

Client:	
Project:	
Contractor:	
Created by:	Verified by:
Date:	File: 060711-3TA_DATASEP
Page number:	Approved:

MAP

Sample Separation

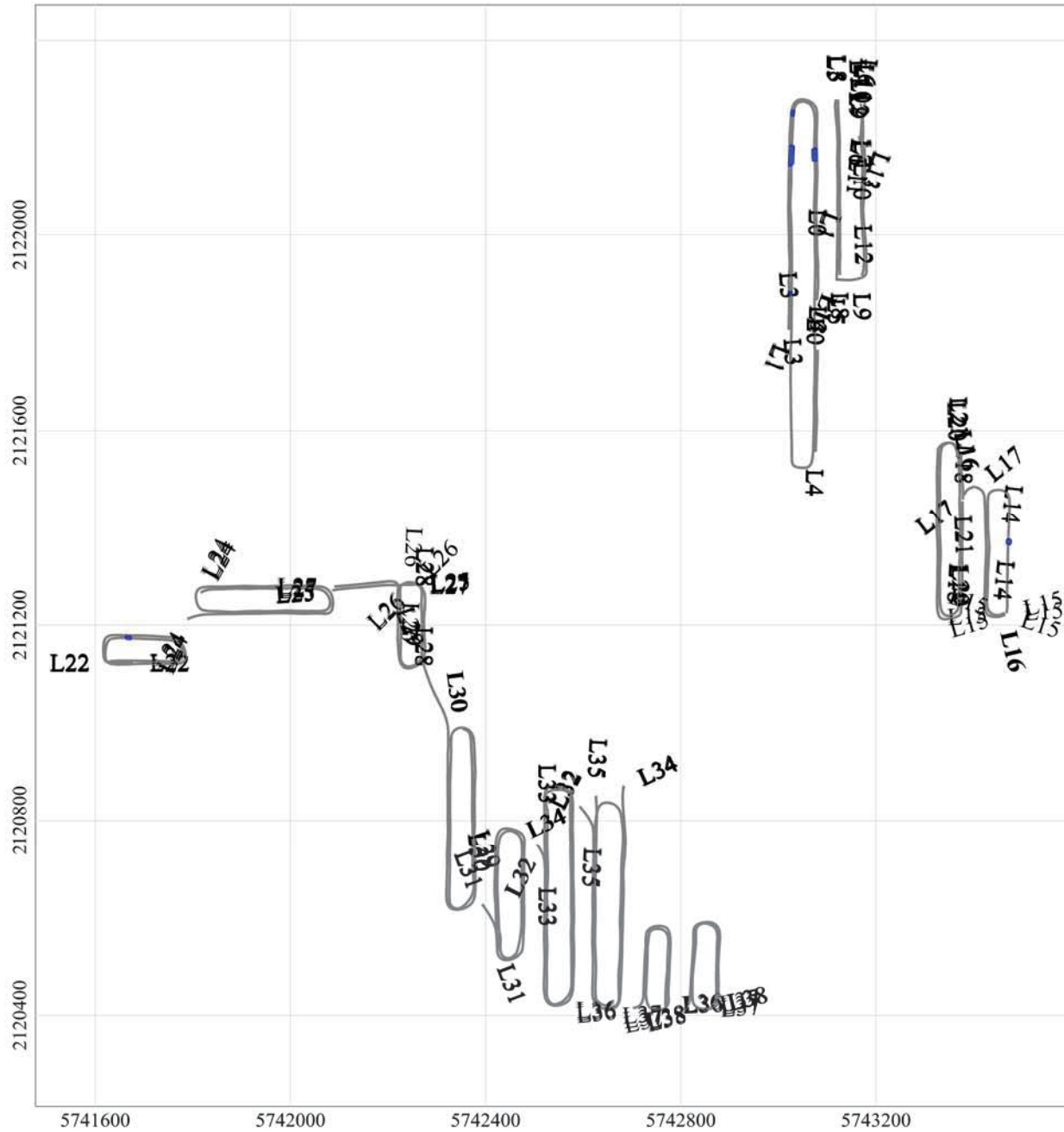

LEGEND

-  Line path
 -  Flag Separation
- Data exceeding max. data spacing: 0.1%



Client:	
Project:	
Contractor:	
Created by:	Verified by:
Date:	File: 060711-4TA_DATASEP
Page number:	Approved:

MAP

Sample Separation

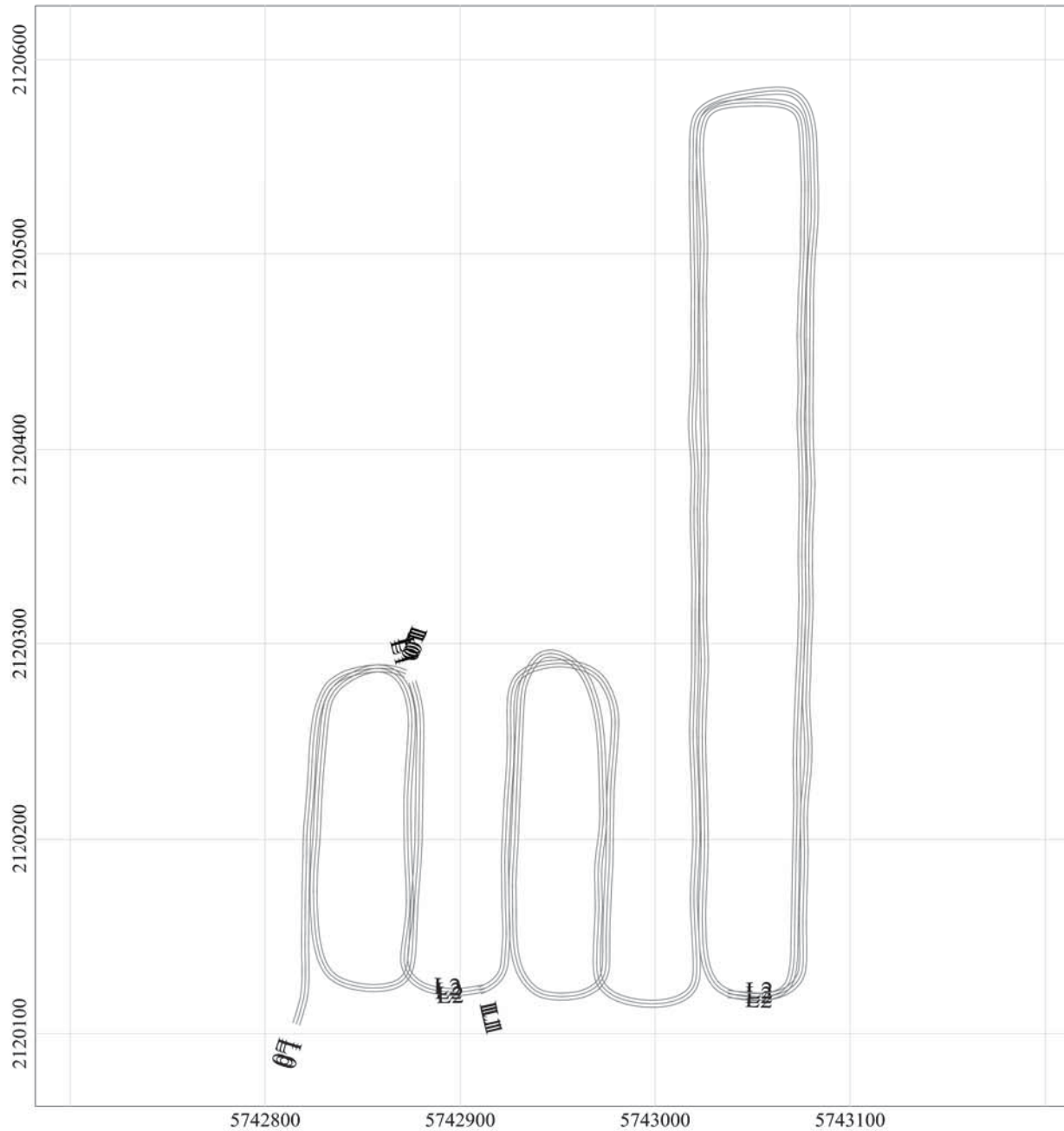

LEGEND

- Line path
 - Flag Separation
- Data exceeding max. data spacing: 0.0%

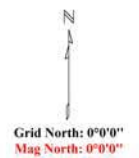

Client:

Project:

Contractor:

Created by:

Verified by:

Date:

File: 060811-ITA_DATASEP

Page number:

Approved:

MAP

Sample Separation

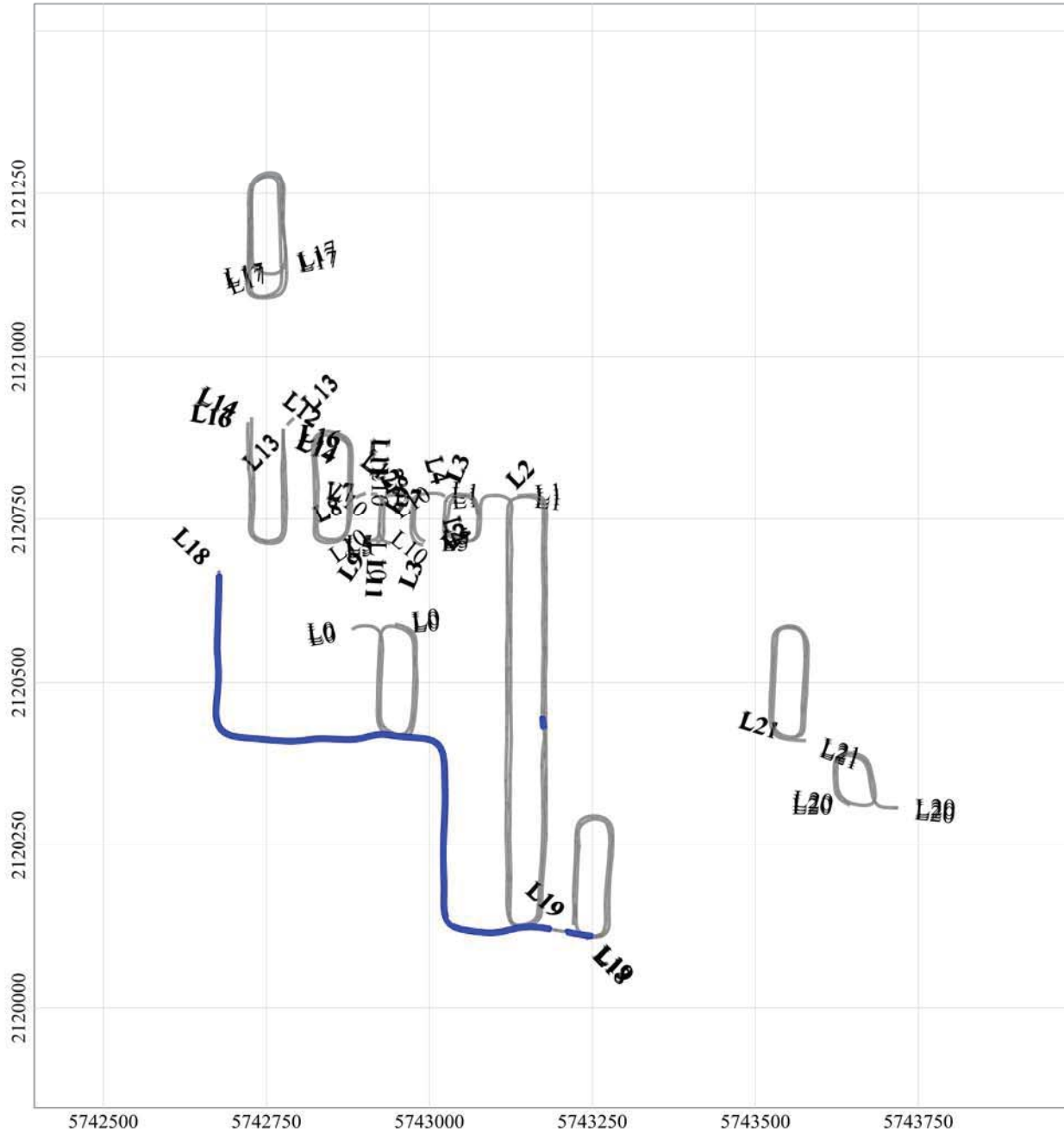

LEGEND

-  Line path
 -  Flag_Separation
- Data exceeding max. data spacing: 3.9%

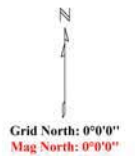

Client:	
Project:	
Contractor:	
Created by:	Verified by:
Date:	File: 060811-2TA_DATASEP
Page number:	Approved:

MAP

Sample Separation

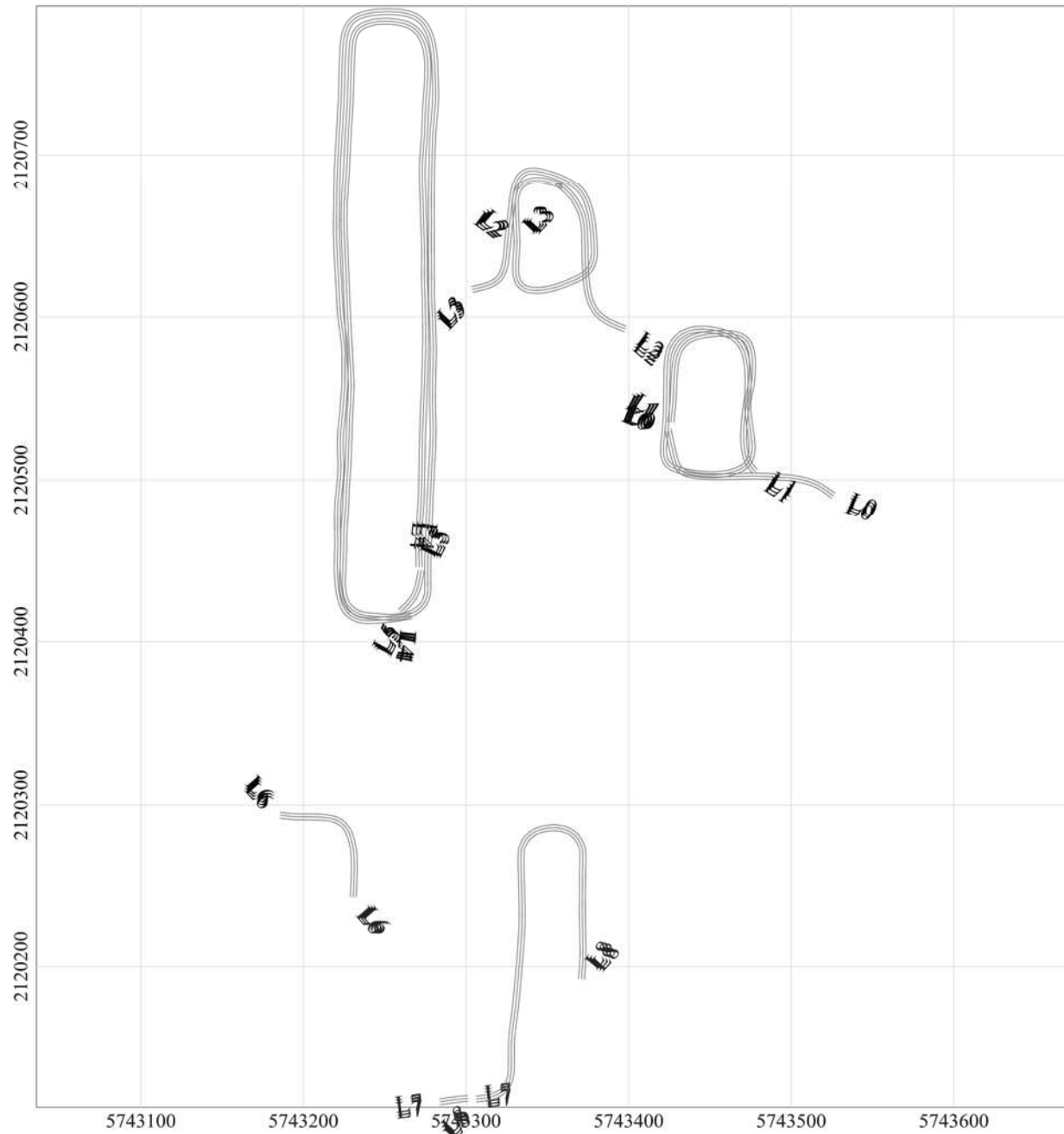

LEGEND

- Line path
 - Flag Separation
- Data exceeding max. data spacing: 0.0%

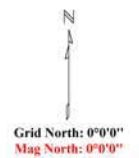

Client:

Project:

Contractor:

Created by:

Verified by:

Date:

File: 060811-3TA_DATASEP

Page number:

Approved:

MAP

Sample Separation

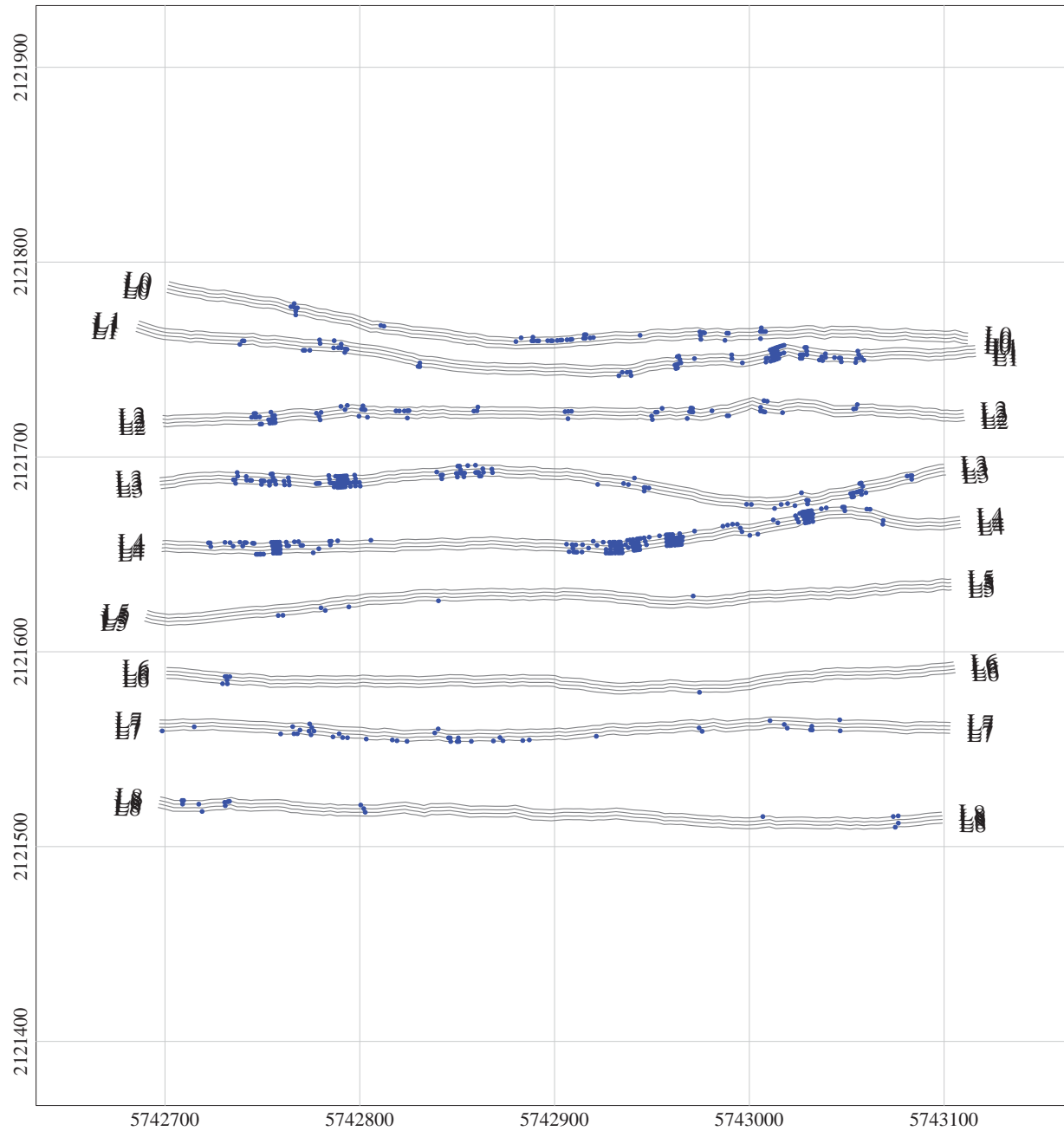

LEGEND

- Line path
 - Flag_Separation
- Data exceeding max. data spacing: 1.4%



Client:	
Project:	
Contractor:	
Created by:	Verified by:
Date:	File: 090512-ITA_DATASEP
Page number:	Approved:

MAP

Sample Separation

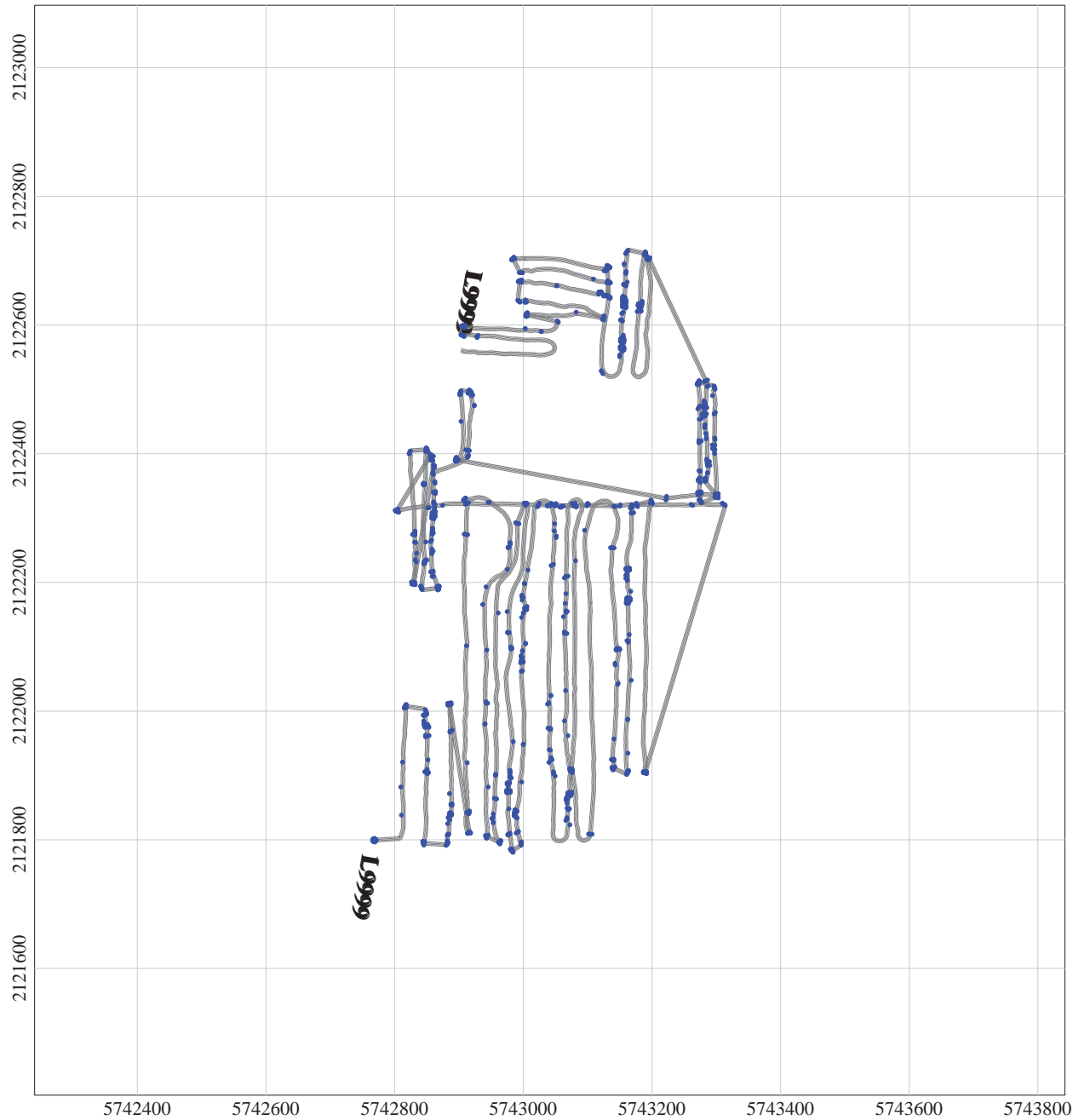

LEGEND

- Line path
 - Flag_Separation
- Data exceeding max. data spacing: 1.2%



Client:	
Project:	
Contractor:	
Created by:	Verified by:
Date:	File: 090512-2TA_DATASEP
Page number:	Approved:

MAP

Sample Separation

LEGEND

- Line path
- Flag_Separation
- Data exceeding max. data spacing: 0.1%

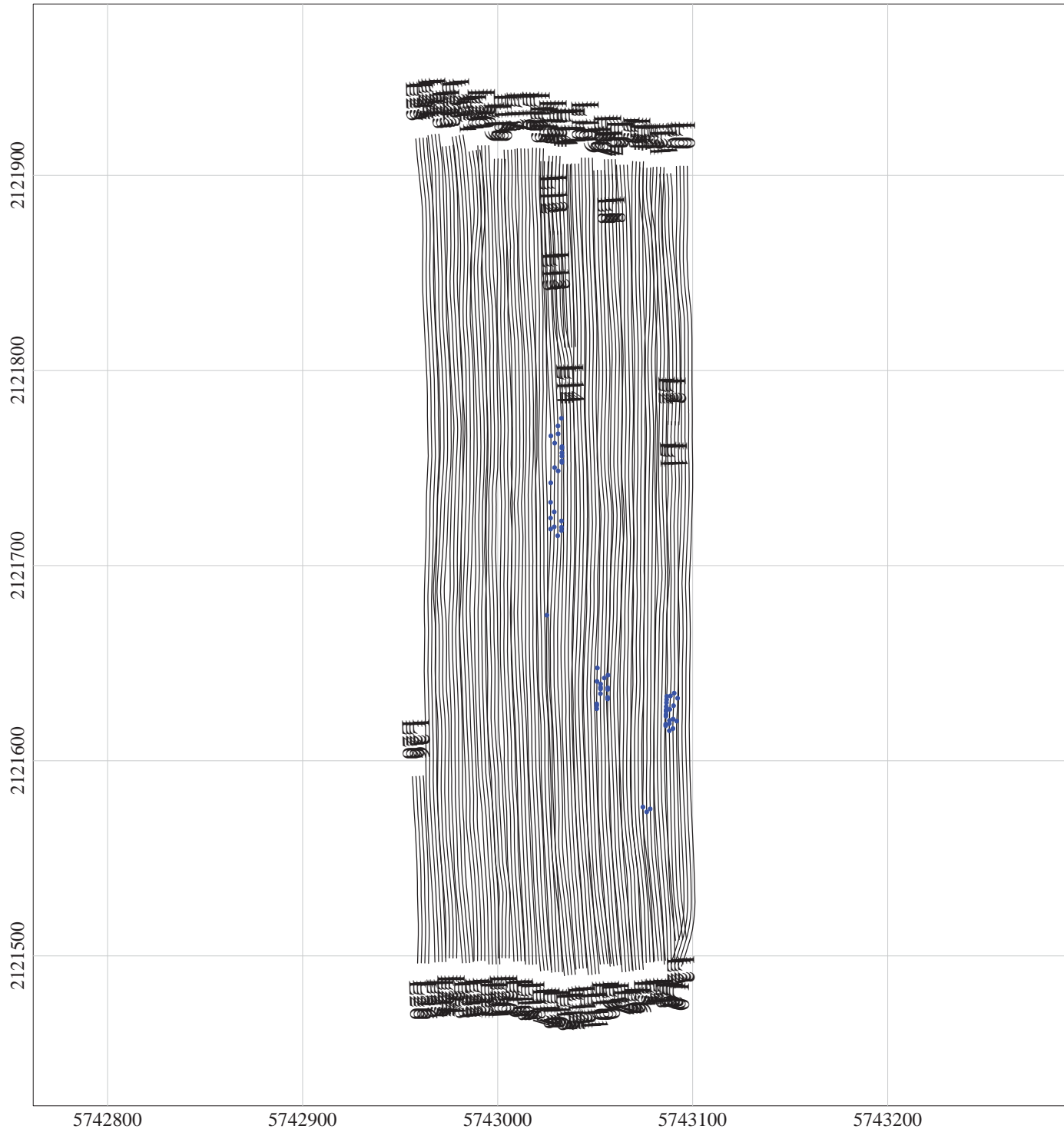

Client:	
Project:	
Contractor:	
Created by:	Verified by:
Date:	File: 102611-1TA_DATASEP
Page number:	Approved:

MAP

Sample Separation

LEGEND

- Line path
 - Flag_Separation
- Data exceeding max. data spacing: 0.0%

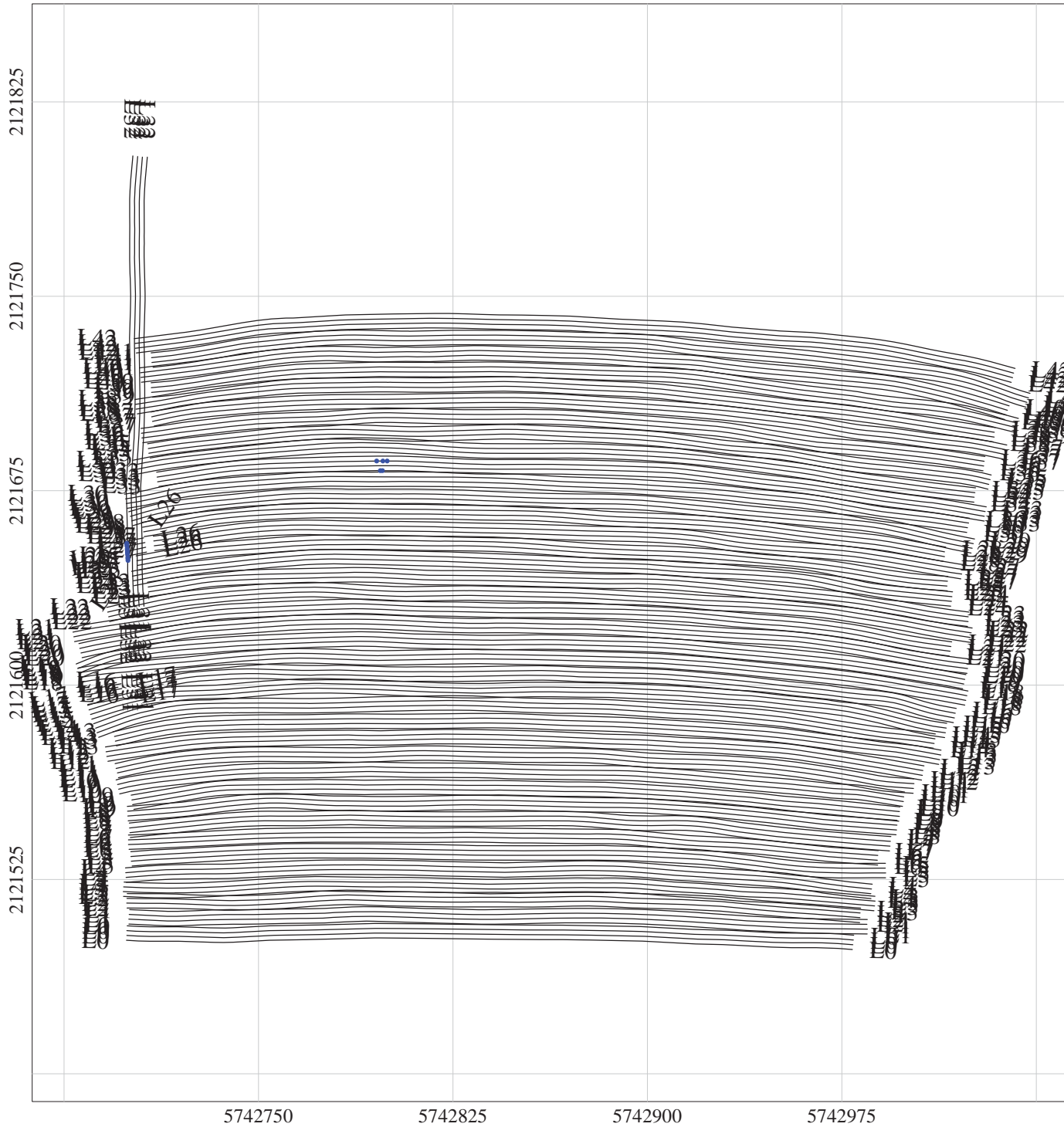

Client:	
Project:	
Contractor:	
Created by:	Verified by:
Date:	File: 102711-1TA_DATASEP
Page number:	Approved:

MAP

Sample Separation

LEGEND

- Line path
- Flag_Separation
- Data exceeding max. data spacing: 1.3%

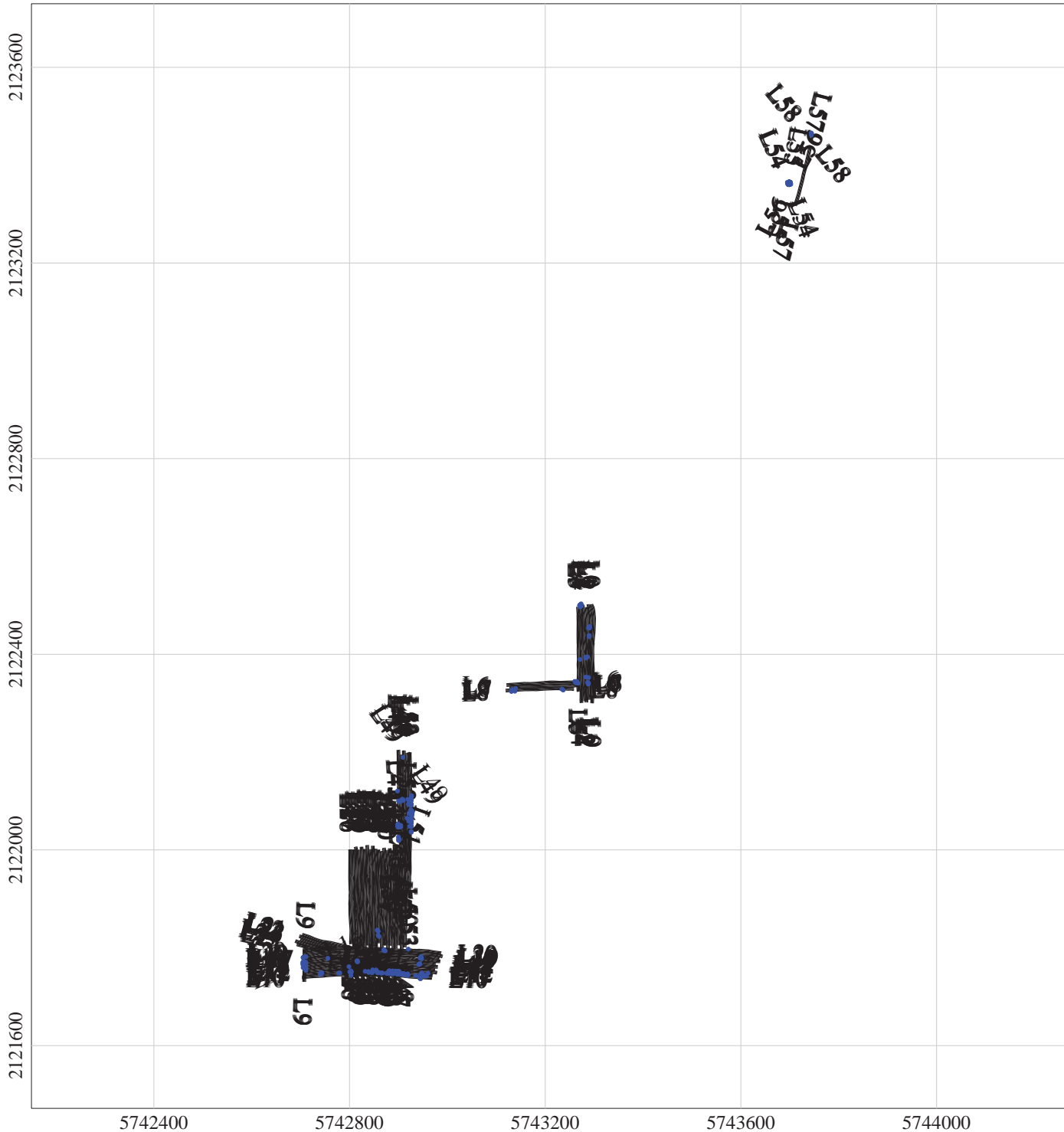



Client:	
Project:	
Contractor:	
Created by:	Verified by:
Date:	File: 102711-2TA_DATASEP
Page number:	Approved:

MAP

Sample Separation

LEGEND

-  Line path
 -  Flag_Separation
- Data exceeding max. data spacing: 1.3%

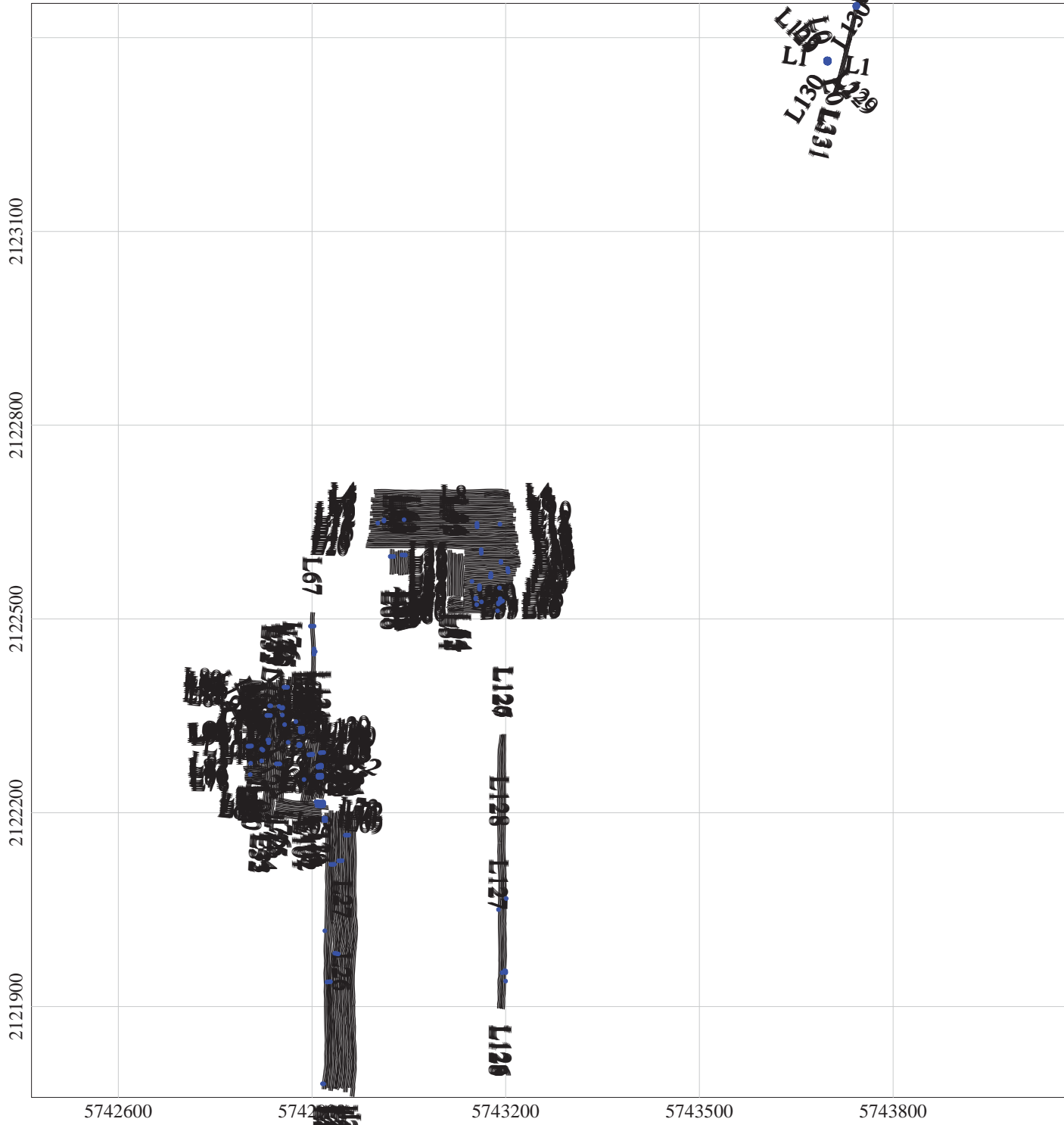

Client:	
Project:	
Contractor:	
Created by:	Verified by:
Date:	File: 102811-1TA_DATASEP
Page number:	Approved:

MAP

Sample Separation

LEGEND

- Line path
 - Flag_Separation
- Data exceeding max. data spacing: 5.0%

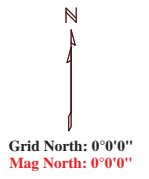
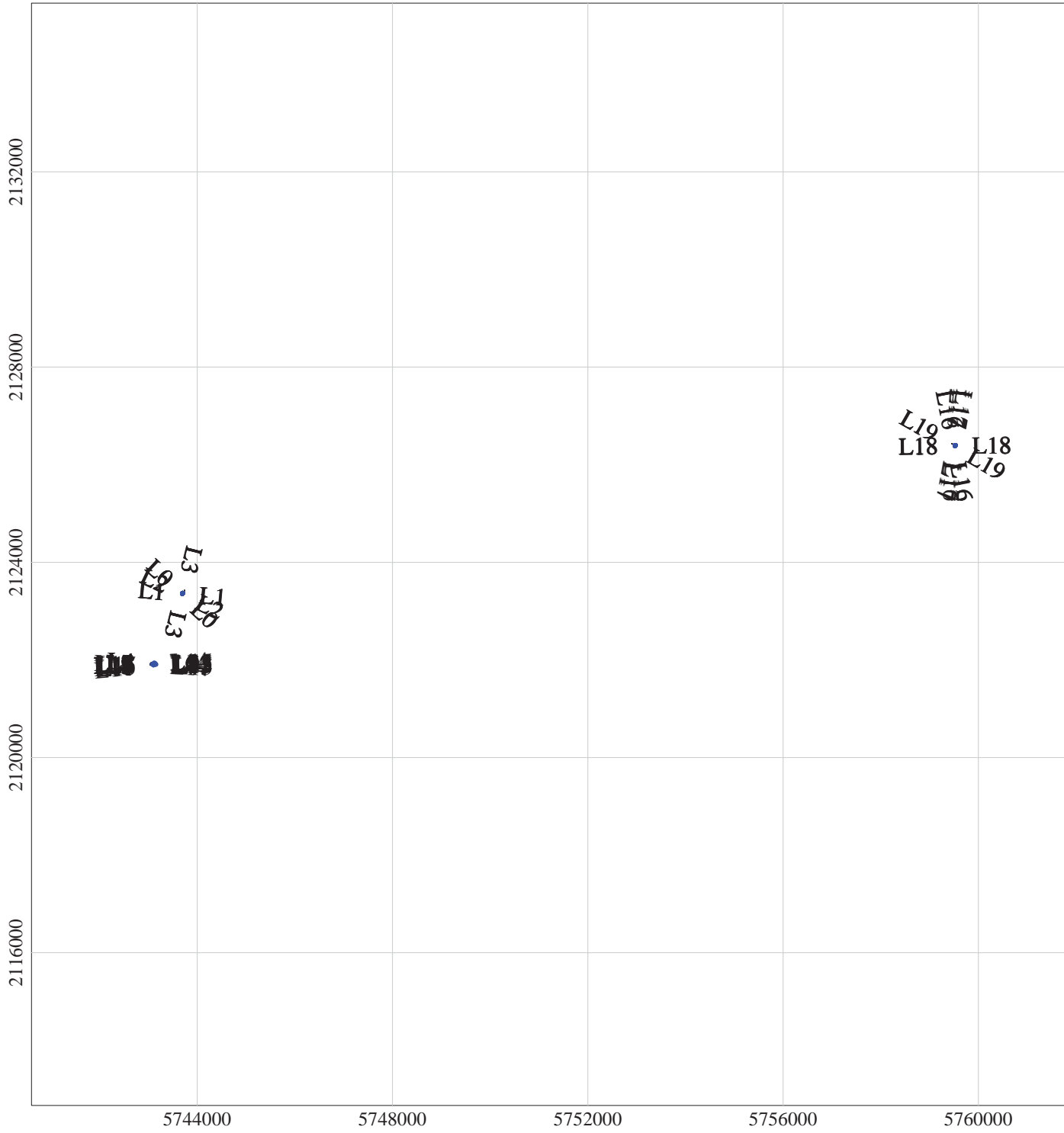

Client:	
Project:	
Contractor:	
Created by:	Verified by:
Date:	File: 110111-1aTA_DATASEP
Page number:	Approved:

MAP

Sample Separation

LEGEND

- Line path
- Flag_Separation
- Data exceeding max. data spacing: 0.4%

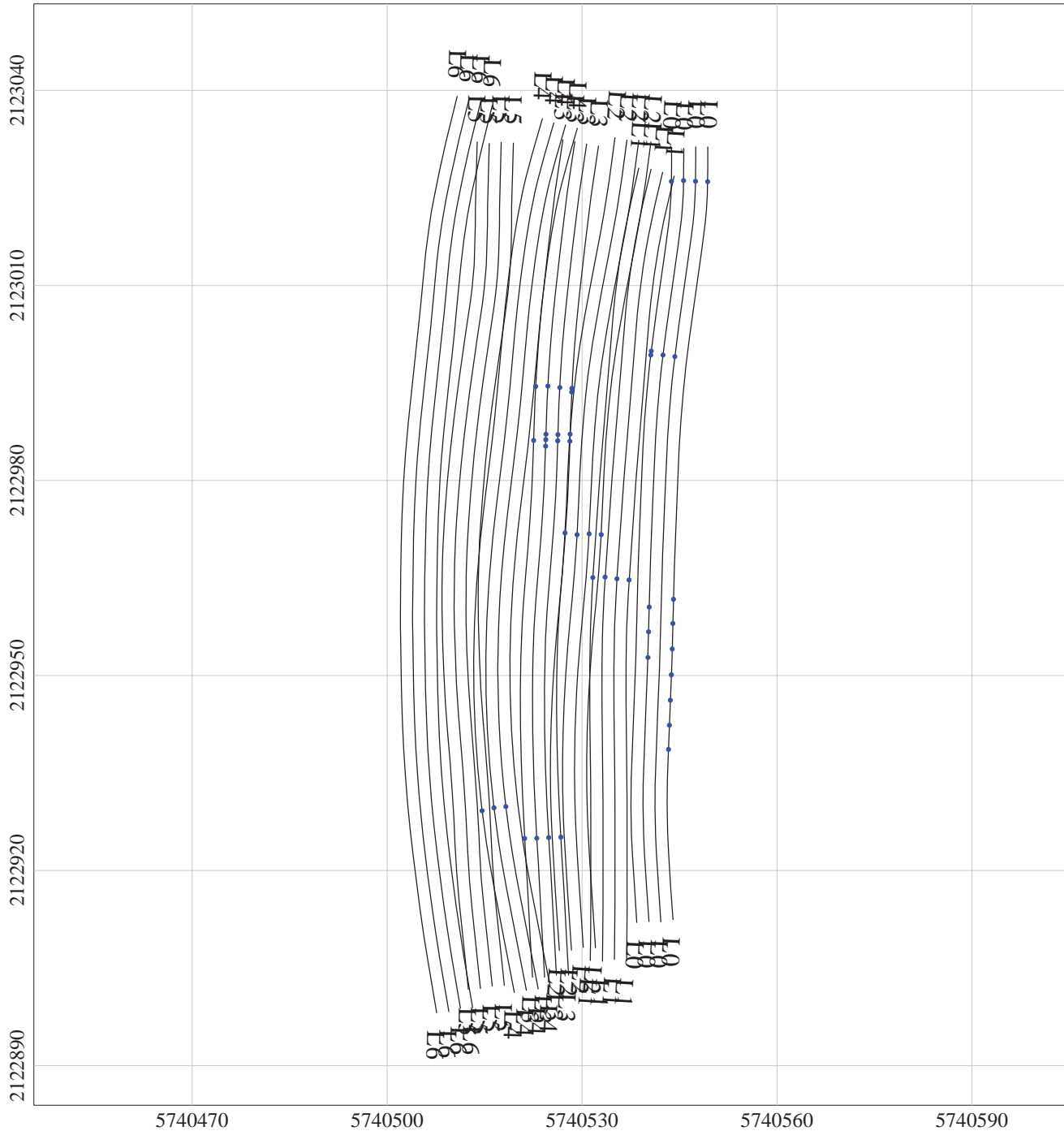



Client:	
Project:	
Contractor:	
Created by:	Verified by:
Date:	File: 110111-1TA_DATASEP
Page number:	Approved:

MAP

Sample Separation

LEGEND

-  Line path
 -  Flag_Separation
- Data exceeding max. data spacing: 0.0%

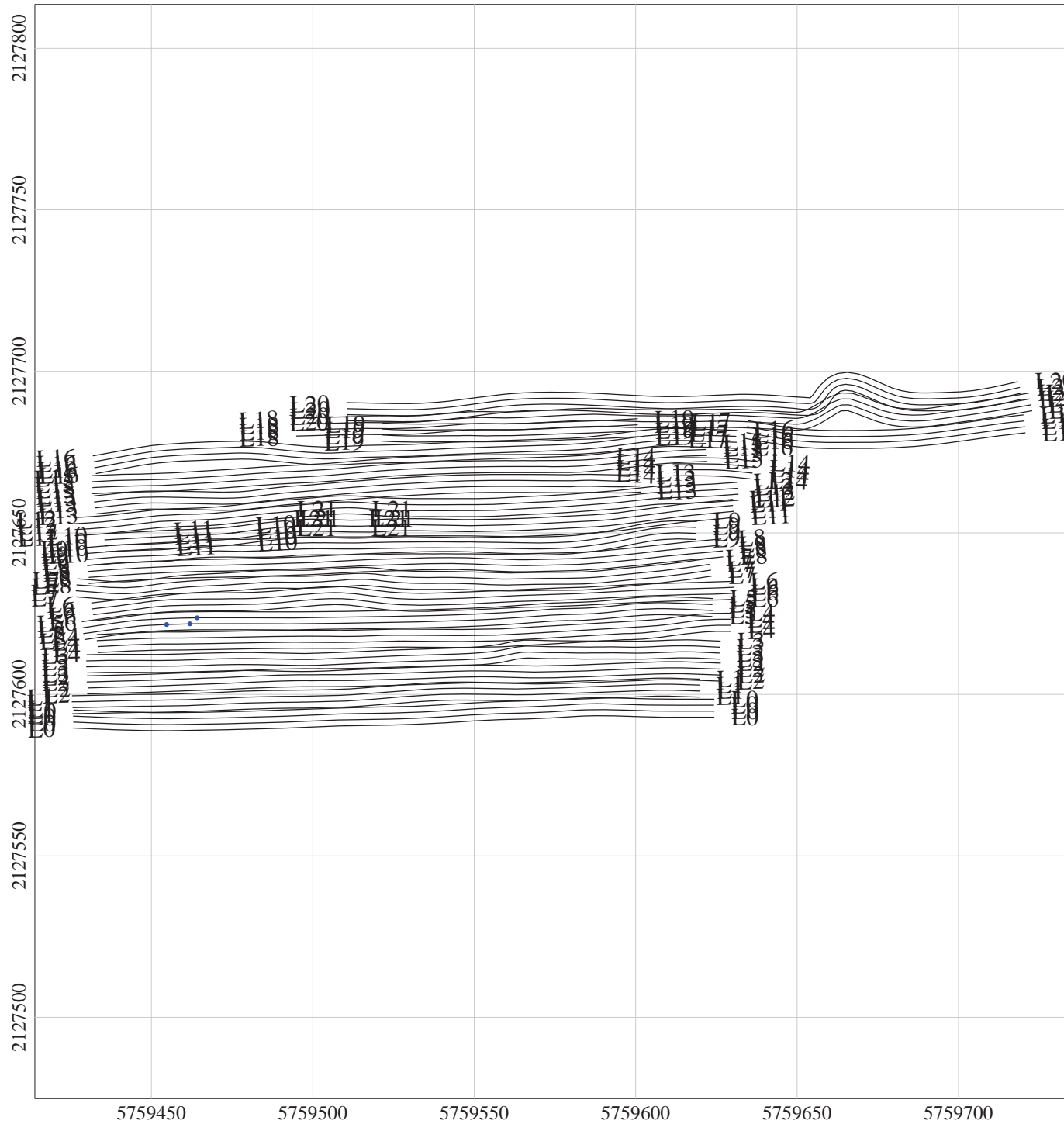

Client:	
Project:	
Contractor:	
Created by:	Verified by:
Date:	File: 110111-2TA_DATASEP
Page number:	Approved:

MAP

Sample Separation

LEGEND

- Line path
 - Flag_Separation
- Data exceeding max. data spacing: 0.1%

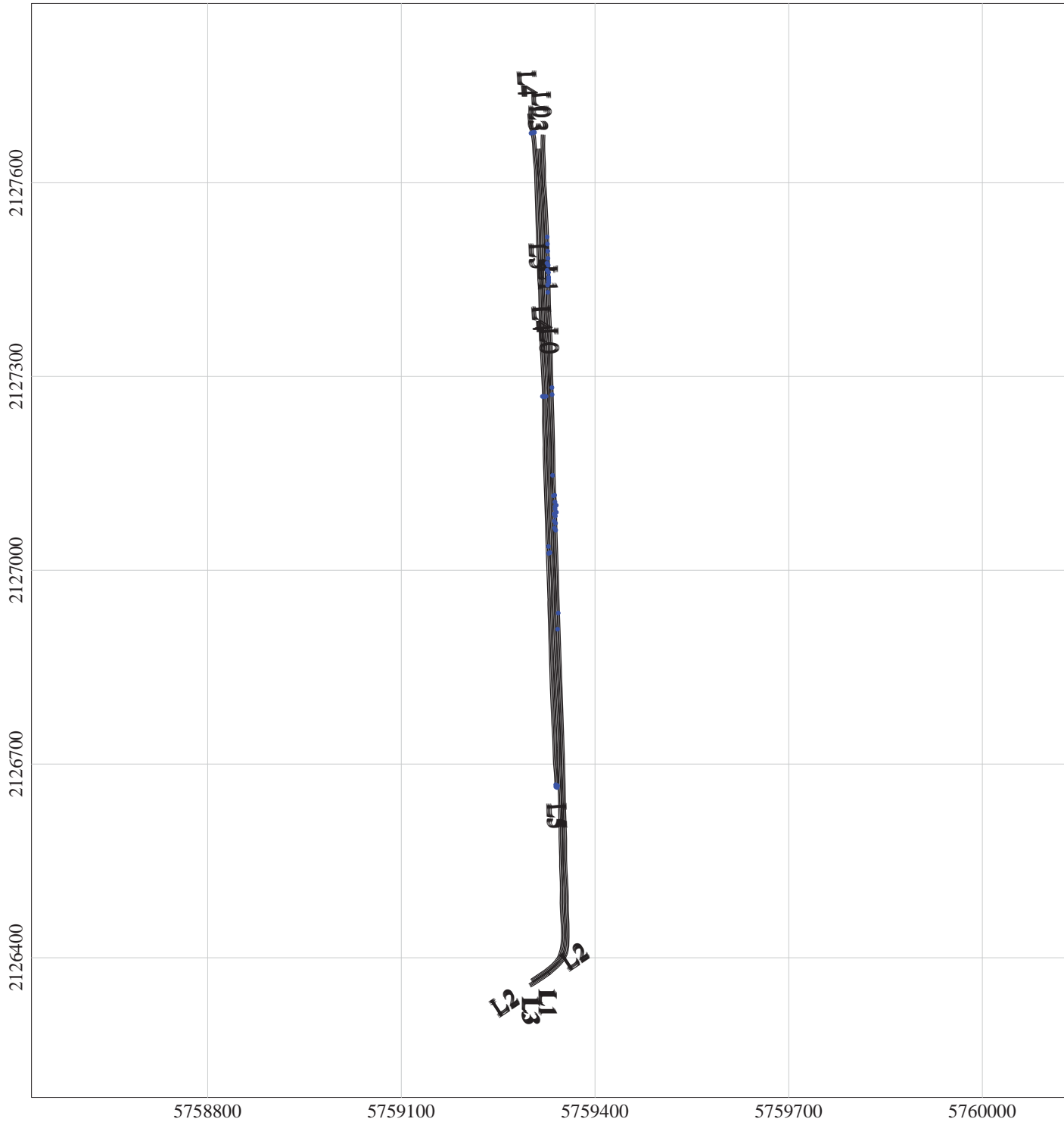

Client:	
Project:	
Contractor:	
Created by:	Verified by:
Date:	File: 110111-3TA_DATASEP
Page number:	Approved:

MAP

Sample Separation

LEGEND

- Line path
 - Flag_Separation
- Data exceeding max. data spacing: 0.0%

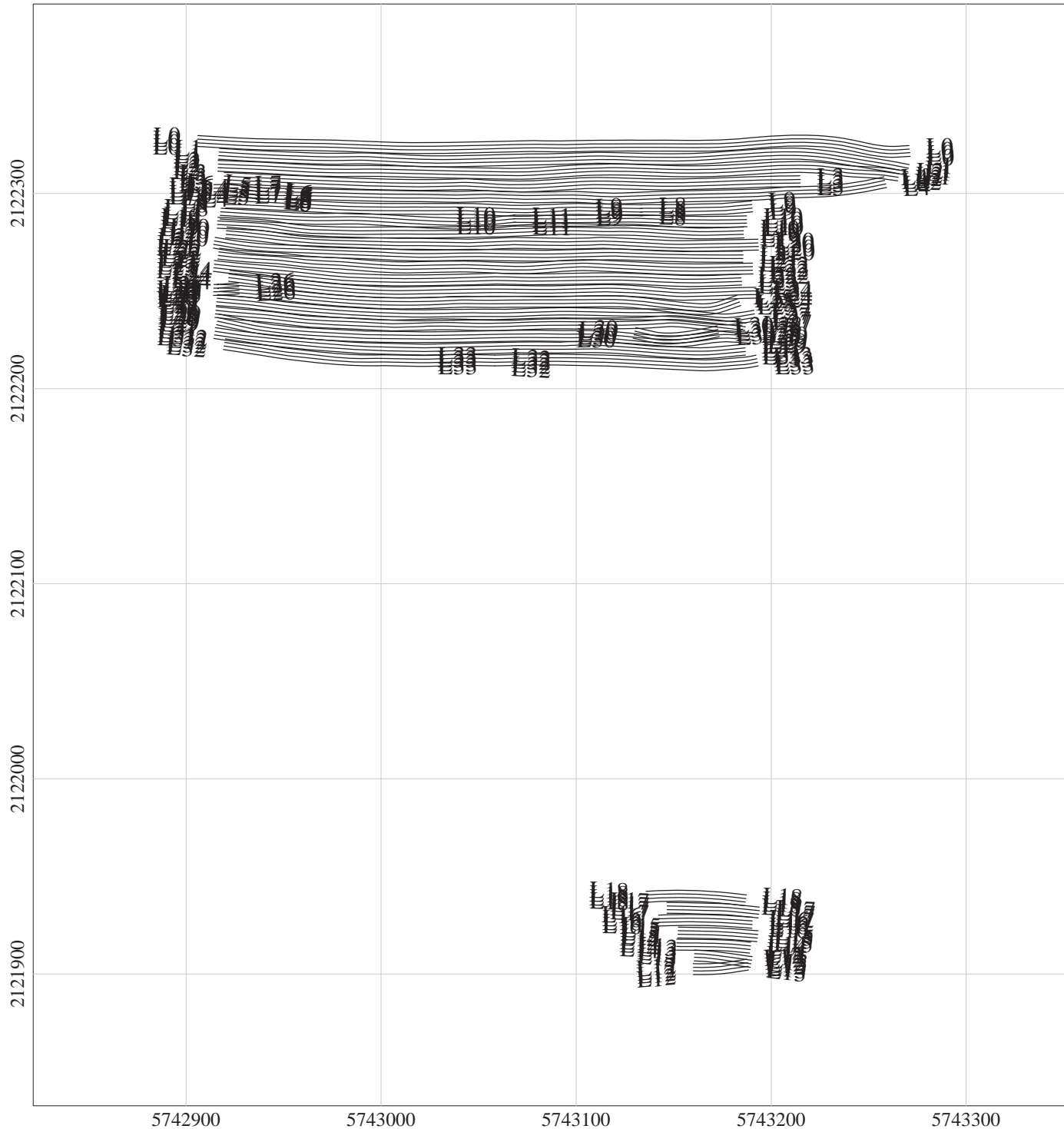

Client:	
Project:	
Contractor:	
Created by:	Verified by:
Date:	File: 110211-1TA_DATASEP
Page number:	Approved:

MAP

Sample Separation

LEGEND

- Line path
- Flag_Separation
- Data exceeding max. data spacing: 0.2%

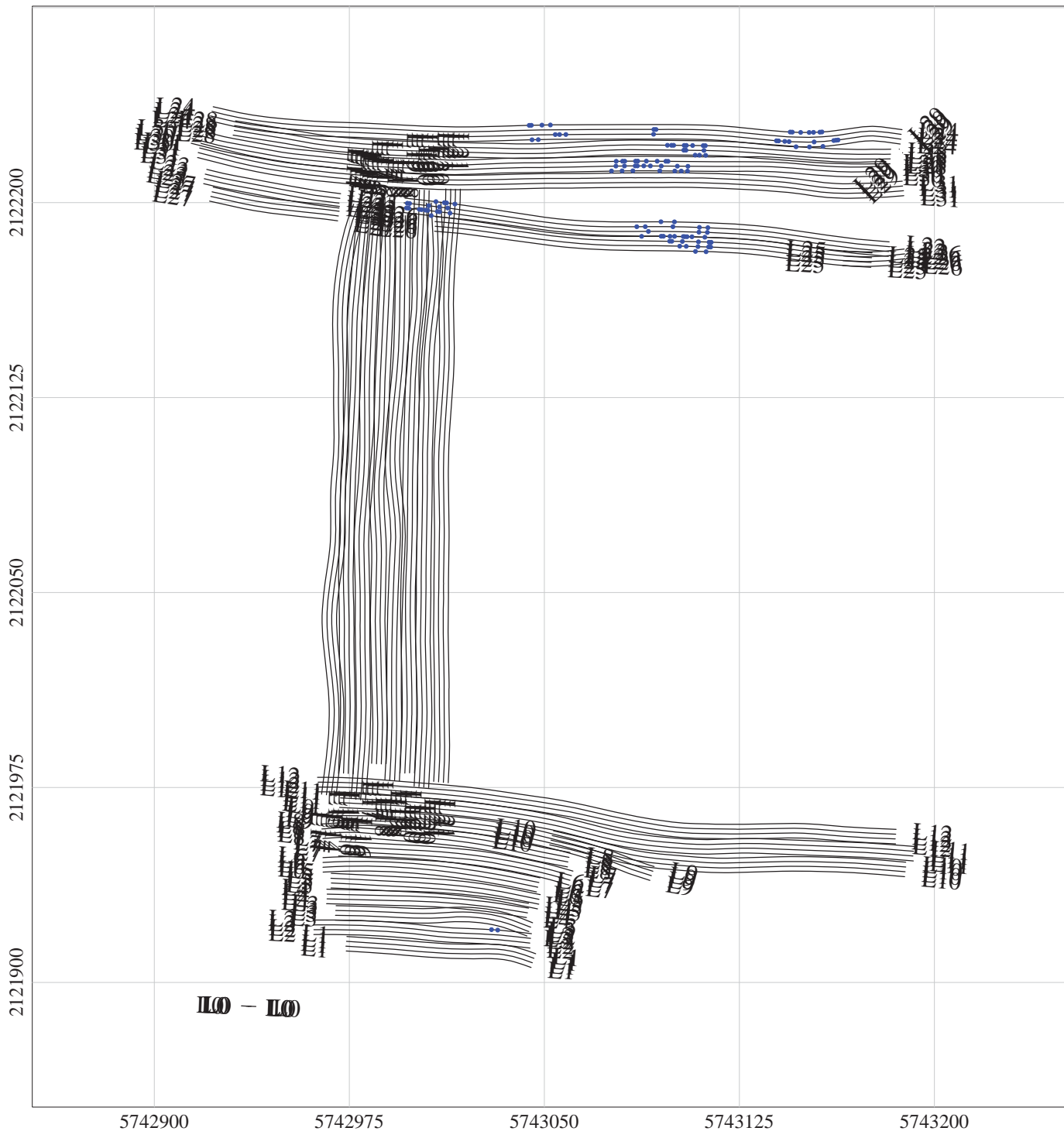

Client:	
Project:	
Contractor:	
Created by:	Verified by:
Date:	File: 110211-2TA_DATASEP
Page number:	Approved:

MAP

Sample Separation

LEGEND

- Line path
 - Flag_Separation
- Data exceeding max. data spacing: 0.0%

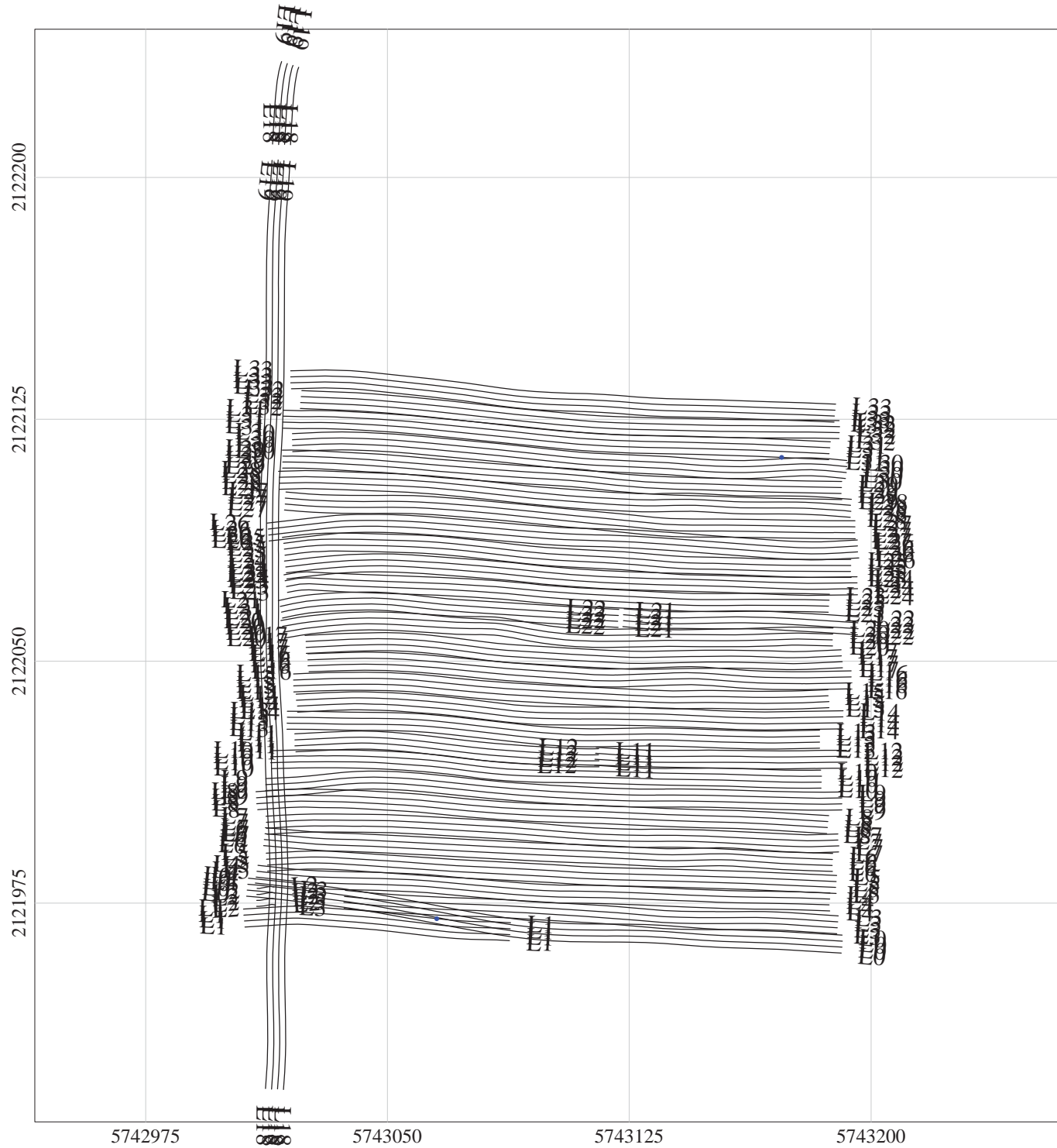



Client:	
Project:	
Contractor:	
Created by:	Verified by:
Date:	File: 110311-1TA_DATASEP
Page number:	Approved:

MAP

Sample Separation

LEGEND

-  Line path
-  Flag_Separation
- Data exceeding max. data spacing: 1.2%

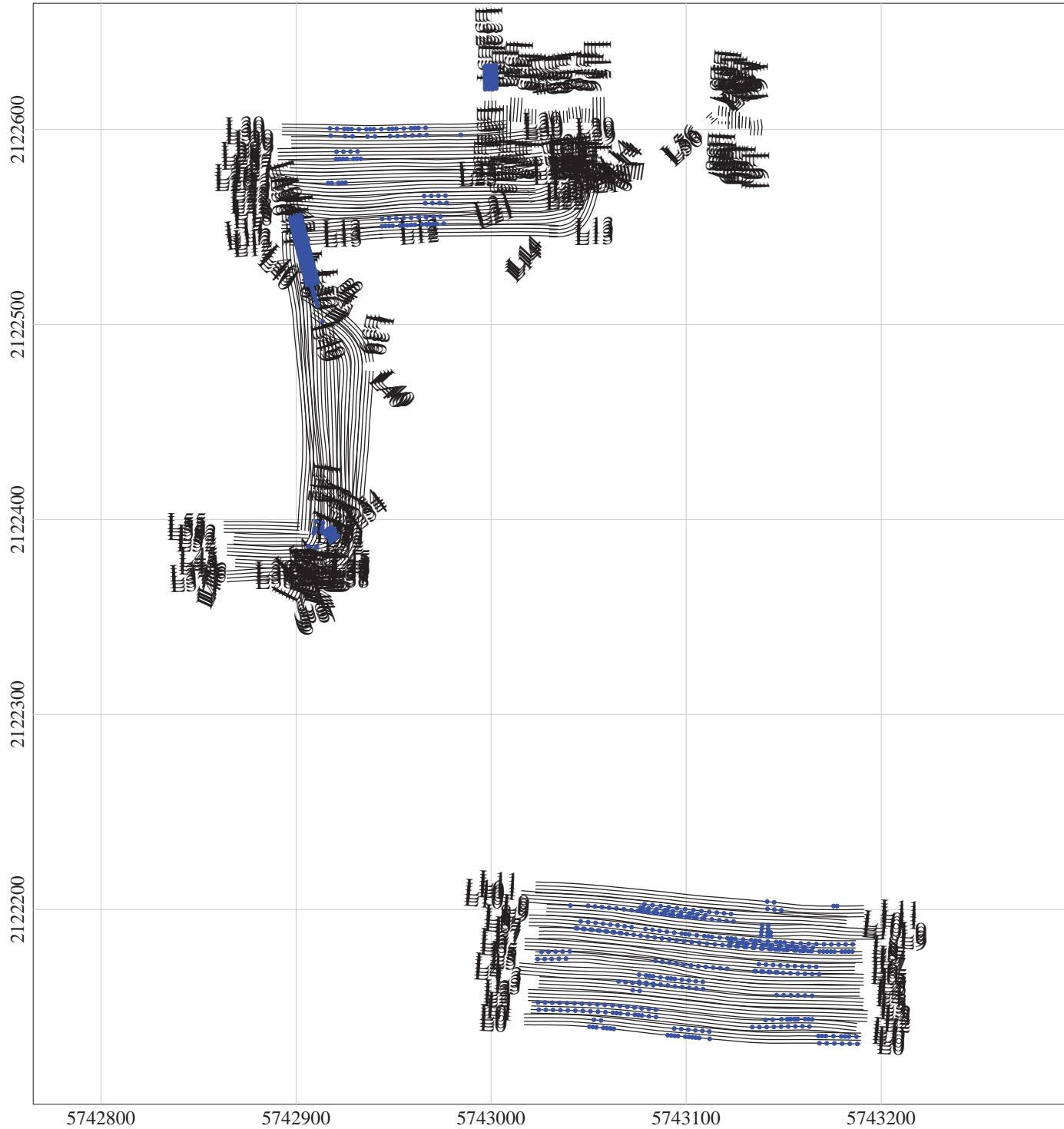



Client:	
Project:	
Contractor:	
Created by:	Verified by:
Date:	File: 110311-2TA_DATASEP
Page number:	Approved:

MAP

Sample Separation

LEGEND

-  Line path
 -  Flag Separation
- Data exceeding max. data spacing: 0.0%

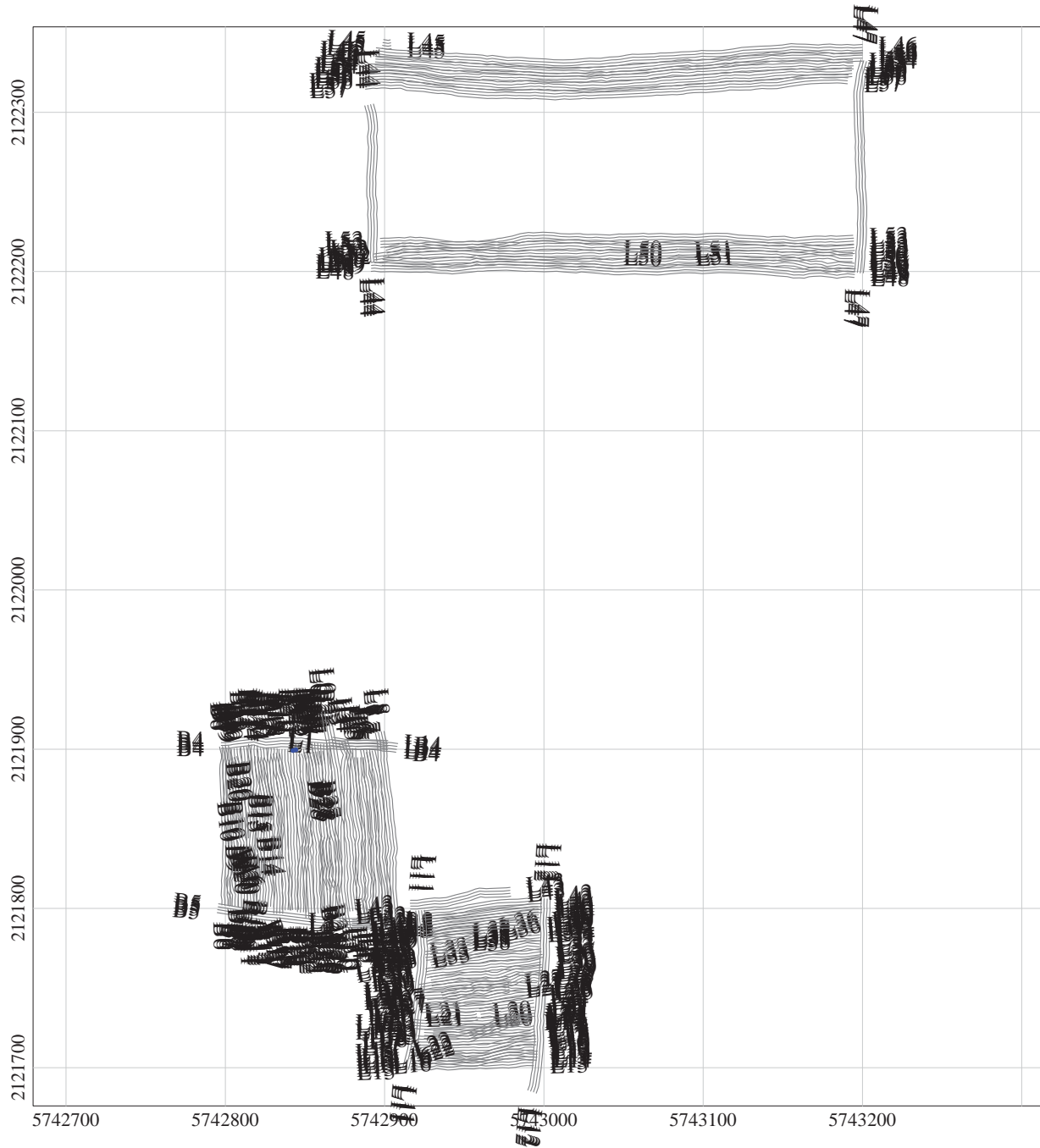

Client:	
Project:	
Contractor:	
Created by:	Verified by:
Date:	File: 121712-2TA_DATASEP
Page number:	Approved:

MAP

Sample Separation

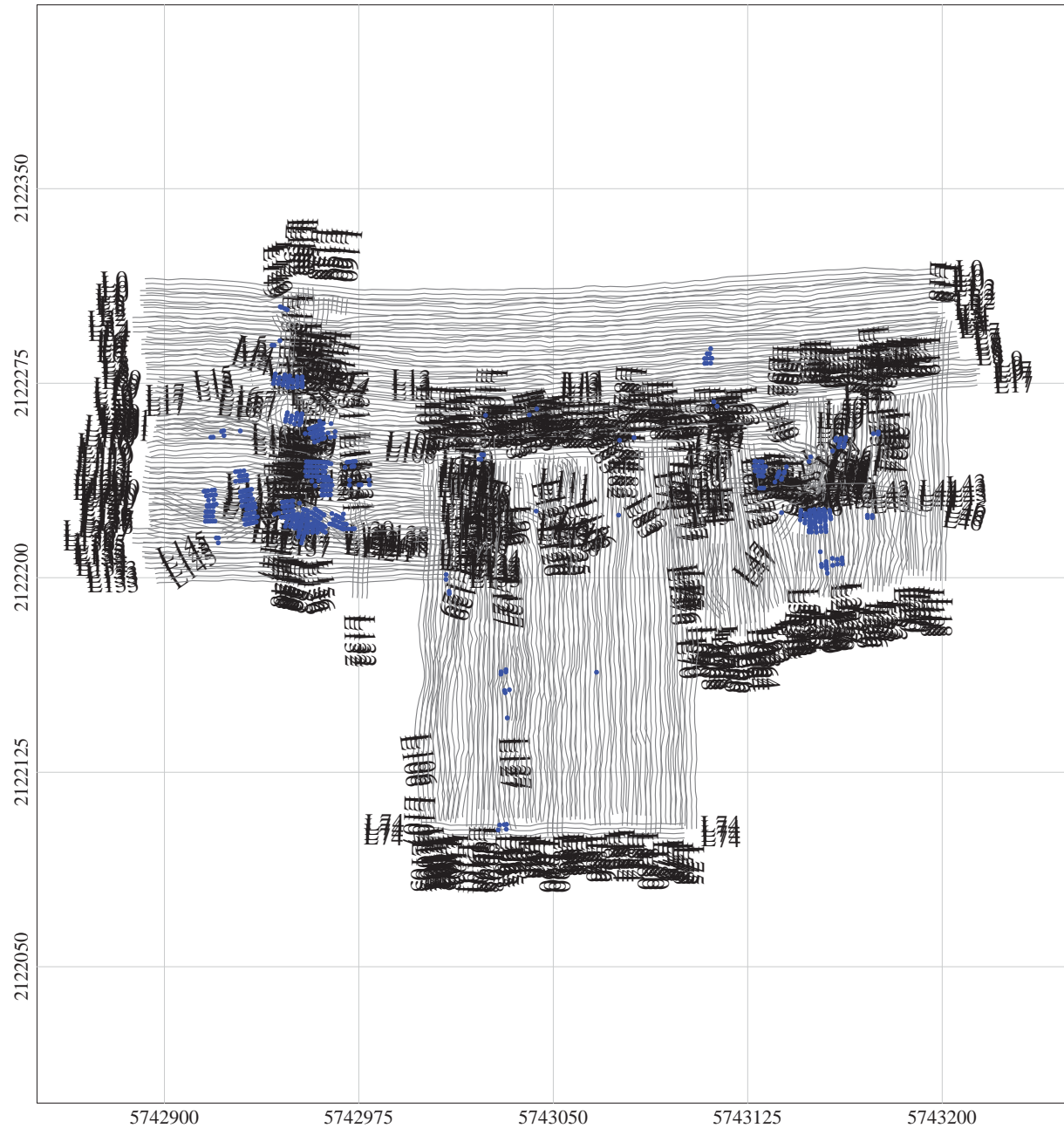

LEGEND

- Line path
 - Flag Separation
- Data exceeding max. data spacing: 0.4%



Grid North: 0°0'0"
Mag North: 0°0'0"

Client:	
Project:	
Contractor:	
Created by:	Verified by:
Date:	File: 121812-ITA_DATASEP
Page number:	Approved: